

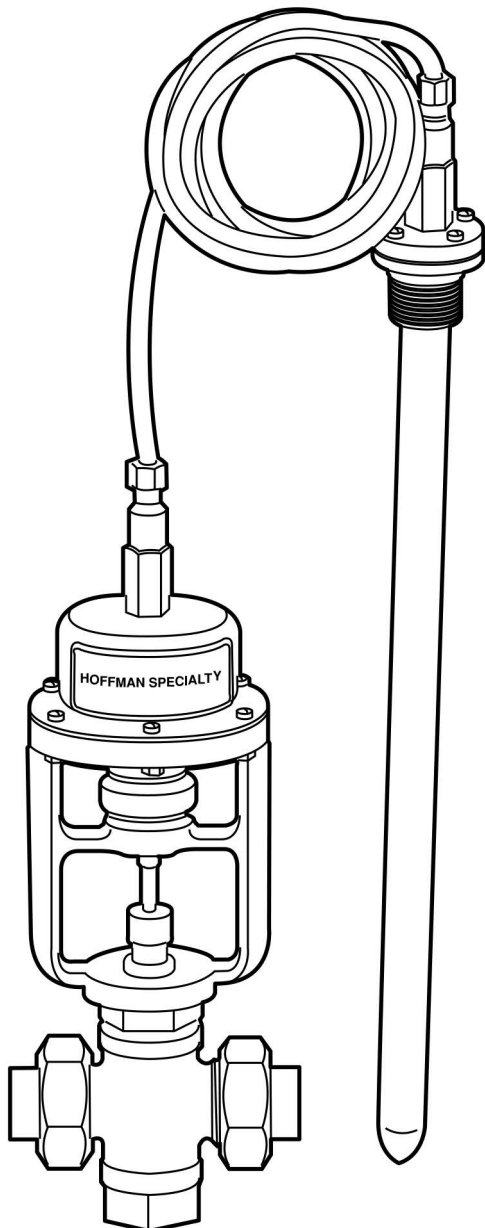

Hoffman Specialty[®] Series 1140 and 1141 Temperature Regulators



CAUTION



- FOLLOW ALL INSTALLATION AND OPERATING INSTRUCTIONS.
- TURN OFF WATER OR STEAM BEFORE SERVICING.
- WEAR HEAT-RESISTANT GLOVES BEFORE MAKING ADJUSTMENTS.
- OPEN SUPPLY VALVES SLOWLY TO PREVENT WATER HAMMER OR SUDDEN SHOCK.
- HANDLE REGULATOR WITH EXTREME CAUTION. DO NOT LIFT REGULATOR BY ANY EXTERNAL TUBING. DO NOT KINK OR TWIST TUBING AND AVOID BENDING IT ON A RADIUS LESS THAN 4" (100 mm).
- THE SENSING BULB MUST NOT BE EXPOSED TO TEMPERATURES THAT EXCEED THE RANGE LISTED ON THE NAME PLATE.
- ALARMS OR CUT-OFFS SHOULD BE INSTALLED ON CRITICAL APPLICATIONS TO INDICATE REGULATOR FAILURE. A LEAK COULD CAUSE THE ACTUATOR TO LOSE ITS CHARGE AND CAUSE THE SYSTEM TO OVERHEAT.
- THIS PRODUCT CAN EXPOSE YOU TO CHEMICALS INCLUDING LEAD, WHICH IS KNOWN TO THE STATE OF CALIFORNIA TO CAUSE CANCER AND BIRTH DEFECTS OR OTHER REPRODUCTIVE HARM. FOR MORE INFORMATION GO TO: WWW.P65WARNINGS.CA.GOV.
- FAILURE TO FOLLOW THIS CAUTION MAY RESULT IN PROPERTY DAMAGE OR PERSONAL INJURY.

IMPORTANT: If you are uncertain as to the product's adaptability for your application, please call the factory or an authorized representative before installing or using the product.

IMPORTANT: Do not install Series 1141 Temperature Regulators in applications where ambient temperature exceeds the regulator's set control temperature.

OPERATING PRINCIPLE

This Series 1140 regulator automatically controls the flow of steam, water or other medium passing through its valve by responding to temperature changes at the bulb. The bulb contains a liquid which vaporizes when heated. Vapor pressure generated in bulb is transmitted through the capillary tubing to the flexible bellows which moves the valve disc or plunger controlling the flow of the medium through the valve. Movement of the bellows is opposed by a spring, providing a means of adjustment. The regulator only controls within the temperature range stamped on the name plate and can be adjusted to control at any point within its range.

Valves used to control heating cycles are direct acting, i.e., they shut off on increase of temperature.

Valves used to control cooling cycles are reverse acting, i.e., they open on increase of temperature.

Three-way valves are used to mix hot and cold water, or as diverting valves (see Figure 3 and 4 below).

It is necessary that the sensing bulb be completely immersed in the fluid being controlled.

VALVE INSTALLATION

Before installing confirm proper sizing. Oversized valves will not provide good temperature control.

The location and installation of the regulating valve is very important. A pipe line strainer must be installed ahead of all double seated and balanced single seated regulators. Single seated valves have built-in removable strainers. However, it is still good practice to install a strainer before all regulators and to blow all lines of foreign matter on installation. See Figure No. 1.

The regulating valve should be installed as close as possible to the unit being controlled. The regulator must be installed in a vertical position, the bracket assembly above the valve body. Install valve so that arrow cast on valve body points in direction of steam or liquid flow. When controlling steam, the heater or coil should be properly vented and drained. A plain bucket trap should not be used without some provision to eliminate air from the coil. A drip trap should be installed ahead of all steam regulators. See Figure No. 2.

When controlling flow of water used for cooling, the valve can be installed on the supply end and may also be installed on the discharge end of the unit. The position depends largely on the particular case, as some units, such as cylinder liners, cannot stand the full line pressure.

When mixing hot and cold water, check valves should be used on the supplies to the three-way valve, unless the three way valve is used directly at heat exchanger (see Figure No. 3) then check valve need only be on the cold water side. To avoid temperature fluctuation of tempered water line, the thermostatic bulb should be located as close to three-way valve as possible.

These size valves are furnished with standard capillary tubing, 10' (3m) length: 1/2" to 2" NPT and 2-1/2" to 4" (65 to 100 mm).

Three-way valves are sometimes used as diverting valves. See Figure No. 4.

Figure No. 1 - Trapping ahead of steam regulators

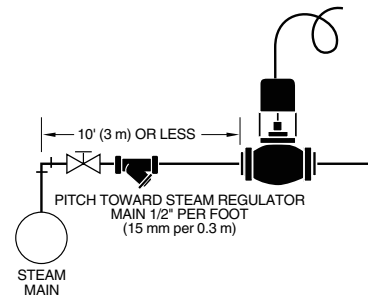

Figure No. 2 - Trapping ahead of steam regulators

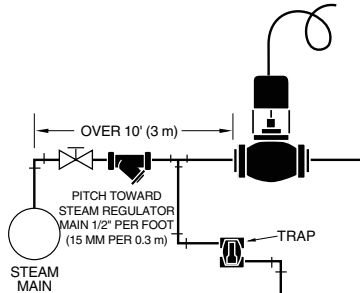
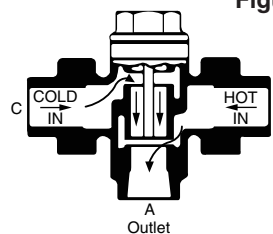

Figure No. 3



Series 1140, 3-way valve mixing service

When temperature increases piston moves down closing port 'B' opening port 'C'.

Figure No. 4

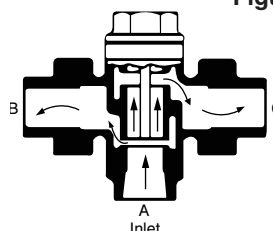

Series 1140, 3-way valve diverting service

When temperature increases piston moves down closing port 'B' opening port 'C'.

BULB INSTALLATION

IMPORTANT: Installing the bulb in the correct location and position is extremely important.

The bulb should be installed at a point of actual system temperature and it must be fully inserted in the fluid being controlled.

Tanks - the bulb should be located approximately $\frac{2}{3}$ the way up and off to a side of the tube nest. Bulbs should be above the heating surface and no closer than 4" (100 mm) at any point.

Instantaneous heaters - the bulb should be installed in the water outlet and as far into the heater as possible.

When a thermometer is used, it should be located **PAST** the bulb at least 6 ft. (1.8 m) in the pipeline or on the same level in the tank.

The bulb can be installed horizontally, vertically or in any position in between the two, if the flange is uppermost (see Figure No. 5). When installed horizontally, the word "TOP" on the flange must be uppermost. See Figure No. 6.

FOR CONTROLLING LIQUIDS

1. Remove the four (4) bushing screws.
2. Remove the bushing from the thermostatic bulb.
3. Determine the correct pipe size opening (see Figure No. 6) and insert bushing in tank or pipeline and tighten securely.
4. Insert bulb and gasket into bushing. Fasten with the four (4) screws.

FOR CONTROLLING AIR

1. Install bulb on right angles to the air movement and where an average temperature prevails.

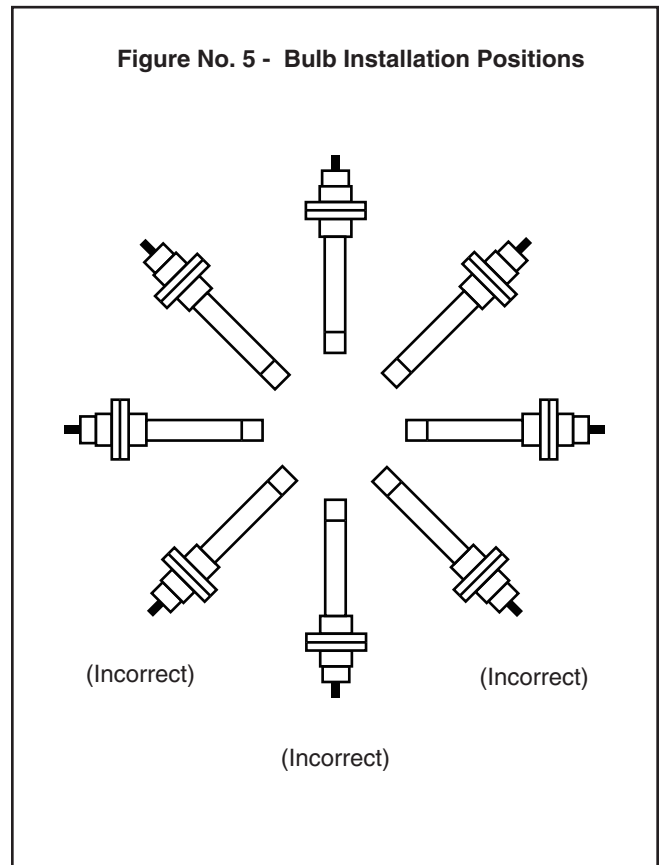
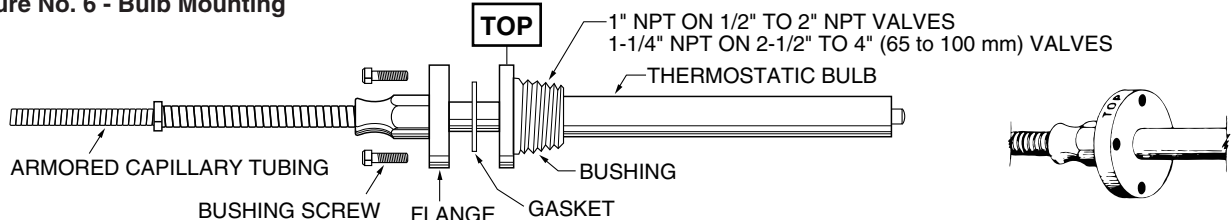

Figure No. 6 - Bulb Mounting



THERMOSTATIC BULB INSTALLATION

FOR THREE-WAY VALVES

1. Install the bulb as close as possible to the outlet of the mixed water line. See Figure No. 7.
2. Immerse bulb as far as possible into the pipeline.

ALL INSTALLATIONS

The capillary tubing is the flexible tubing that connects the bulb and the valve.

IMPORTANT: Capillary tubing may only be bent on a 4" (100 mm), or larger radius. It must never be cut, kinked, smashed or twisted.

1. Permanently fasten the capillary tubing to a permanent location **other than** steam pipes, cold water lines, or any other place where extreme temperatures are incurred.
2. Form a loop with a few turns of tubing and place next to the regulator. This helps to absorb vibrations in the pipeline.

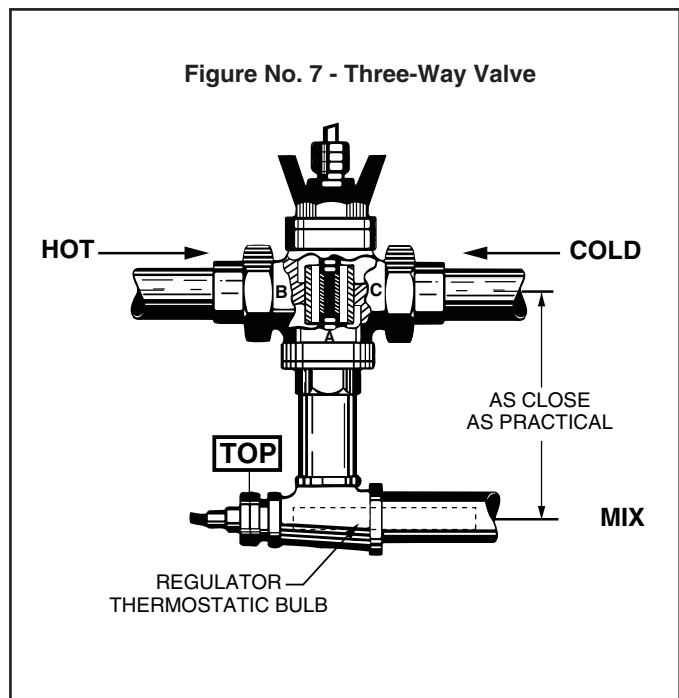

SEPARABLE WELL INSTALLATION

Separable wells protect the bulb and allow the bulb to be removed without draining the pipeline or tank.

1. Install separable well in tank or piping.
2. Coat sensing bulb with high temperature grease.
3. Insert sensing bulb and gasket into the separable well.
4. Securely tighten with four (4) mounting screws.

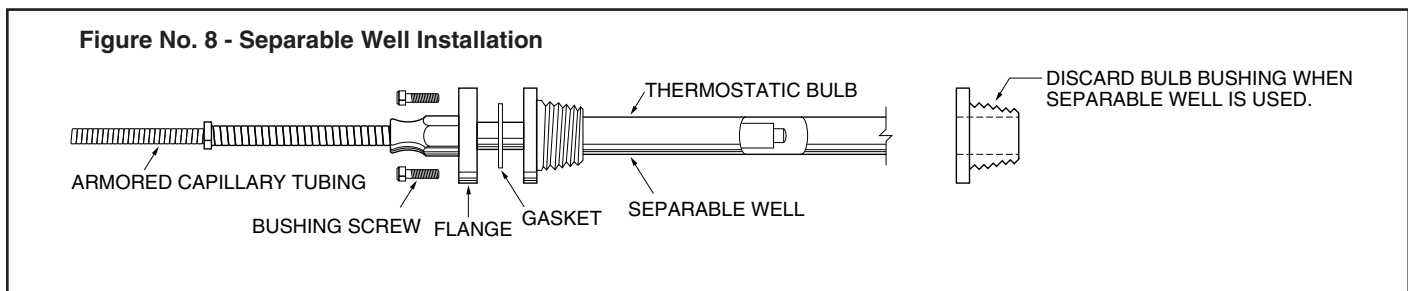

TEMPERATURE ADJUSTMENT

This regulator can be set to control at any temperature within the limits of the temperature range stamped on the name plate. After placing the regulator in service, allow about 15–30 minutes to reach stable operation, then watch temperature, if not correct change temperature setting as outlined hereafter. Make new settings as necessary until desired temperature is obtained. Allow about 15–30 minutes between changes. Oversized valves will cause extreme temperature fluctuations.

SETTING TEMPERATURE

Turn the hand wheel in the direction indicated by arrow (see Figure No. 9). This will compress regulating spring and cause valve to control at a higher temperature; turning hand wheel in opposite direction causes valve to control at a lower temperature. The wheel is mounted on ball bearings to eliminate friction and insure easy operation.

CHECKING VALVE STEM TRAVEL ON TWO-WAY VALVES

The 1/2" to 2" (15 to 50 mm) bronze body regulators have a 1/4" (6 mm) valve movement.

The 2-1/2" (65 mm) up to and including the 4" (100 mm) flanged body valves have a 7/16" (11 mm) valve stem travel.

To check stem travel, proceed as follows:

1. See Figure No. 9.
2. Raise temperature at bulb until valve shuts off.
3. Mark lower stem using Stuffing Box Nut as reference point.
4. Cool entire unit until bellows contracts completely into housing.
5. Reference mark should be either 1/4" or 7/16" (6 or 11 mm) above stuffing box nut, as indicated.

If valve stem has more travel than indicated, valve will not shut off.

CHANGING VALVE DISC MOVEMENT

Under some conditions, it may be necessary to adjust the amount of valve movement. This may occur on oil heater installations, where only a very small quantity of steam is required. Too much valve opening is usually indicated by a decided fluctuation of the oil temperature.

The adjustment is made by holding the upper valve stem and loosening the stem adjustment lock nut and then turning the lower valve stem to the left (clockwise) as looking at the arrow marks on the bracket. This will decrease the amount of valve movement. See Figure No 8.

Always securely tighten the stem adjustment lock nut after adjustment has been made.

Figure No. 9

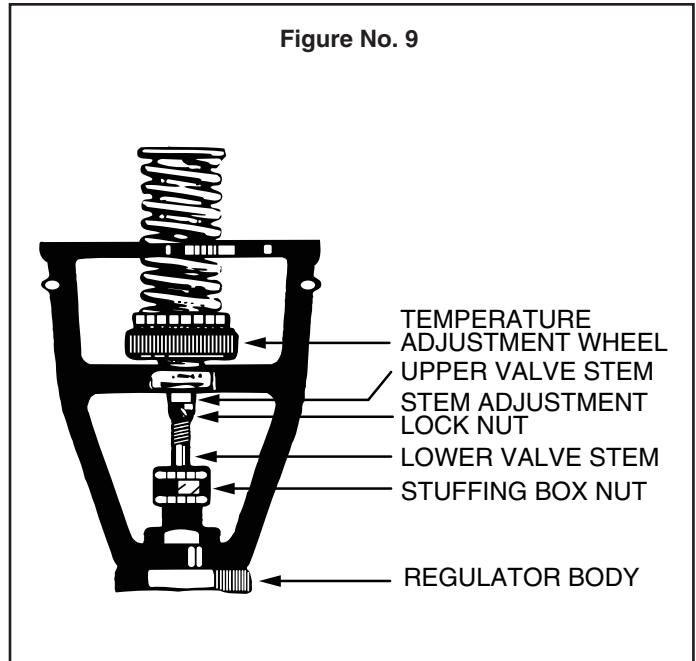

MAINTENANCE

VALVE STEM PACKING:

Apply one drop of oil to the packing every three months.

Replace the packing once a year, or every 6 months in severe environments.

1. Remove packing nut.
2. Lift the packing gland.
3. Install new packing.
4. Replace and hand tighten packing nut.

STRAINERS:

Clean once a month, or more frequently if dirt or debris is present.

Y-Strainers:

1. Open the blowdown valve.
2. Allow the steam or water to flow out for 2 minutes.
3. Close the valve.

Built-in Strainers on Body code 01 or 02 (single-seated type)

1. Remove the bottom plug.
2. Remove and wash screen
3. Reinstall screen and plug.

TRAPS:

Follow trap manufacturer's maintenance instructions.

Figure No. 10

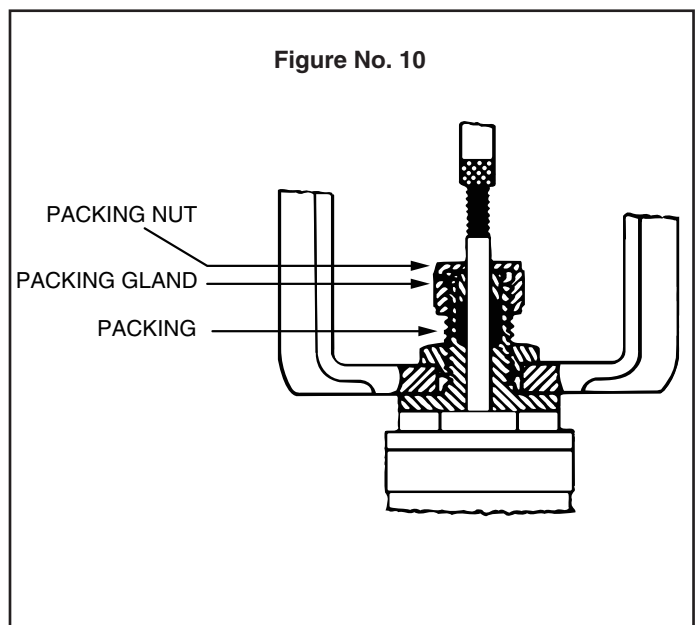

CHANGING A THERMOSTATIC ACTUATOR ON TWO-WAY VALVES

The Thermostatic Actuator used on the Series 1140 regulators is shown in Figure No. 11. All actuator parts shown form one inseparable unit, except for the bulb bushing with its gasket and fastening screws.

The Thermostatic Actuator will only control within the temperature range stamped on the name plate, which is fastened to the bellows housing.

If it is necessary to install a new actuator, to obtain a higher or lower range, the following procedure should be applied. Refer to Figure No. 11.

CAUTION



ALL SUPPLY VALVES MUST BE TURNED OFF, SYSTEM PRESSURE MUST BE REDUCED TO 0 psi (0 bar), AND SYSTEM TEMPERATURE MUST BE REDUCED BELOW 100°F (38°C) BEFORE REMOVING THE BULB. FAILURE TO FOLLOW THIS CAUTION MAY RESULT IN SERIOUS BURNS.

1. On units without a separable well, drain tank or pipe line to a point below location of the thermostatic bulb.
2. Loosen the four (4) bulb bushing screws and slowly break the bulb connection to make sure hot water does not drain out, then remove four (4) screws and take the bulb out of the bushing or well.
3. Turn temperature adjustment wheel to lowest position (clockwise).

CAUTION

REGULATORS OPERATING LOWER THAN 120° - 160° (49° - 71°C) OR IN ROOMS ABOVE 100°F (38°C), THE BELLOWS MUST BE COOLED UNTIL IT CAN BE COMPRESSED BY HAND. FAILURE TO FOLLOW THIS CAUTION COULD DESTROY THE ACTUATOR.

4. Cool bulb and bellows at least 20°F (-6°C) below lowest temperature of range indicated on name plate.
5. Remove the bellows housing nuts and screws and lift unit off bracket (keep bulb cool). Push down by hand on upper valve stem plate until valve is shut. With a pencil make a reference mark on the lower valve stem, where stem enters stuffing box nut. This will assist in checking total valve movement on opening and also the thrust of the new thermostatic actuator.
6. Cool the new thermostatic actuator bulb which is to be installed, at least 20°F (-6°C) lower than the lowest temperature marked on the name plate.

Actuators for valves in sizes 2-1/2" to 4" and with ranges lower than 120° to 160°F (49 to 71°C) are shipped with a clip, so that the bellows cannot expand beyond limits in transit. Before removing this clip, make sure you can compress bellows by hand. Only then remove clip and attach housing to bracket, by fastening the six (6) bellows housing screws. This must be done quickly.
7. Recheck valve stem travel as outlined in paragraph "Checking Valve Stem Travel" on page 5.

Figure No. 11

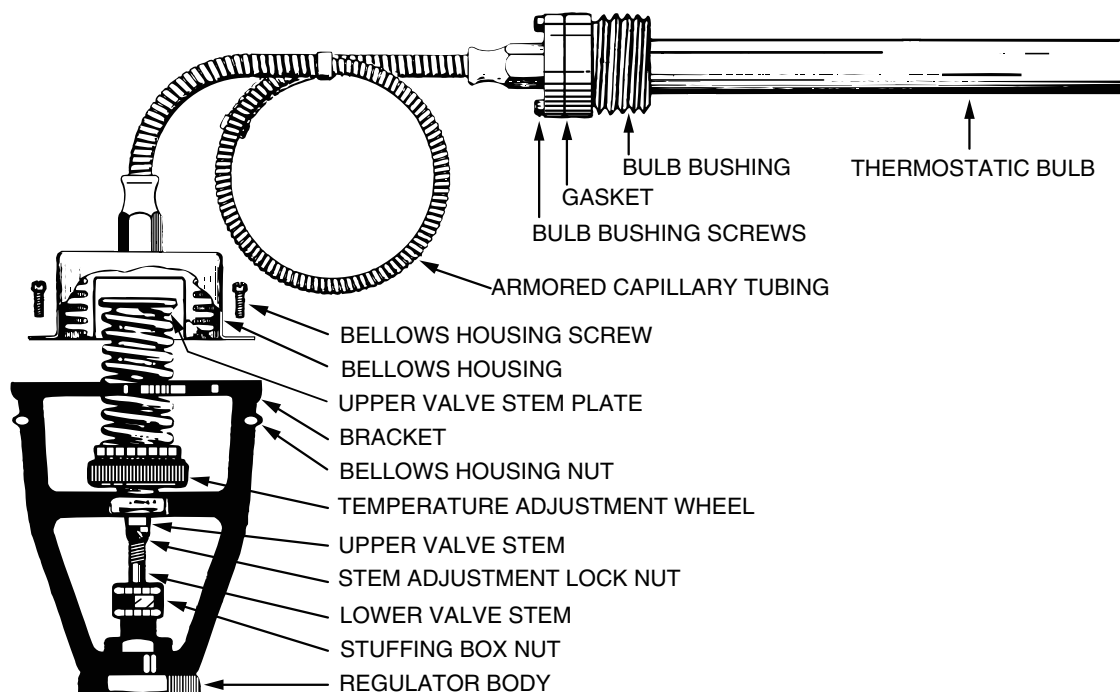

CHANGING A THERMOSTATIC ACTUATOR ON THREE-WAY VALVES

⚠ CAUTION



ALL SUPPLY VALVES MUST BE TURNED OFF, SYSTEM PRESSURE MUST BE REDUCED TO 0 psi (0 bar), AND SYSTEM TEMPERATURE MUST BE REDUCED BELOW 100°F (38°C) BEFORE REMOVING THE BULB. FAILURE TO FOLLOW THIS CAUTION MAY RESULT IN SERIOUS BURNS.

1. Secure all water to valve and outlet from valve.
2. Drain pipe line below location of thermostatic bulb, if no well is used.
3. When you are sure the water has been drained and all internal pressure is relieved, remove the four bulb bushing screws and take the thermostatic bulb out of the bulb bushing.
4. Turn the temperature adjustment wheel to the lowest position.
5. Cool the bulb and bellows at least 20°F (-6°C) below the lowest temperature range indicated on the name plate.

⚠ CAUTION

REGULATORS OPERATING LOWER THAN 120° - 160° (49° - 71°C) OR IN ROOMS ABOVE 100°F (38°C), THE BELLOWS MUST BE COOLED UNTIL IT CAN BE COMPRESSED BY HAND. FAILURE TO FOLLOW THIS CAUTION COULD DESTROY THE ACTUATOR.

6. Remove the bellows housing nuts and screws and lift unit off bracket.
7. Turn temperature adjustment wheel up sufficiently to put enough tension on the spring to hold the cold port shut.
8. Place a spacer 3/32" (2.4 mm) thick (2 pennies) on upper stem plate and replace bellows housing (completely cooled) holding it down so flange rests on ring of bracket. If stem adjustment has not been disturbed, stem will just move opening cold port. Remove spacer and fasten bellows housing in place.
9. If stem does not move, unscrew upper stem from lower stem a turn at a time until this movement is obtained.
10. Stem should move 1/32" (0.8 mm). Screw upper stem down on lower stem until this amount of movement is obtained.
11. Lock the two stems in this position with the stem adjustment lock nut.
12. Attach housing to bracket.
13. Install bulb in pipe line with "top" on top.

Figure No. 12

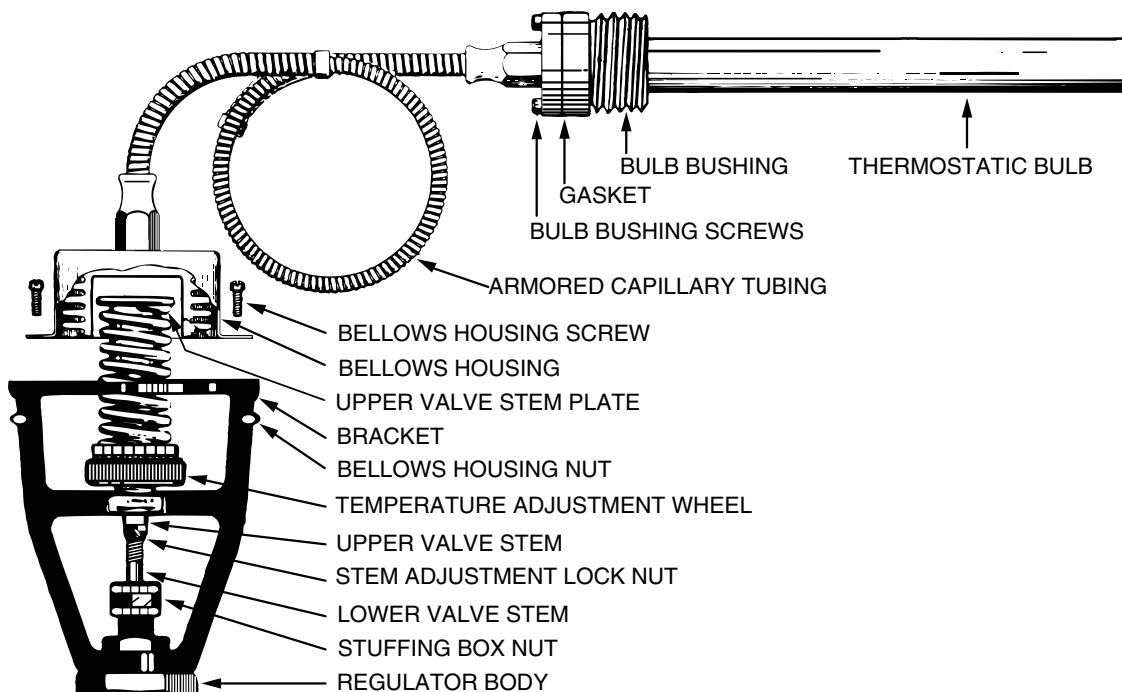

THREE WAY MIXING VALVES

IMPORTANT: When installing a three-way mixing valve, it is necessary that return circulation be piped to feed the cold water side of the mixing valve and heater. See Figure No. 13.

As the temperature of the mixed liquid increases, the piston moves toward the hot seat port B. See Figure 3 on page 2. This movement decreases the hot flow and increases the cold flow through port C. See Figure 3 on page 2. The thermostat maintains the piston in the proper position for the desired mixed temperature.

TO CHECK THE OPERATION OF A THREE-WAY VALVE USED AS A MIXING VALVE PROCEED AS FOLLOWS:

Check the packing gland to see if it is only hand tight. If this gland is too tight, it will bind the valve stem. Then open one or two outlets in the hot water line to establish a flow of water through the valve. Check temperature on thermometer. If it is not at the desired point, increase or decrease the temperature by turning the adjustment wheel in the proper direction for a higher or lower temperature. The proper direction is indicated by an arrow on valve bracket. Two turns of the adjustment wheel should make an appreciable change in outlet temperature.

If the temperature at the outlet drops below the desired point, check the temperature of the hot water entering the valve. If it is below the required temperature, the coil or heater is not making enough hot water. This condition must be remedied before any further adjustment can be made on the three-way valve.

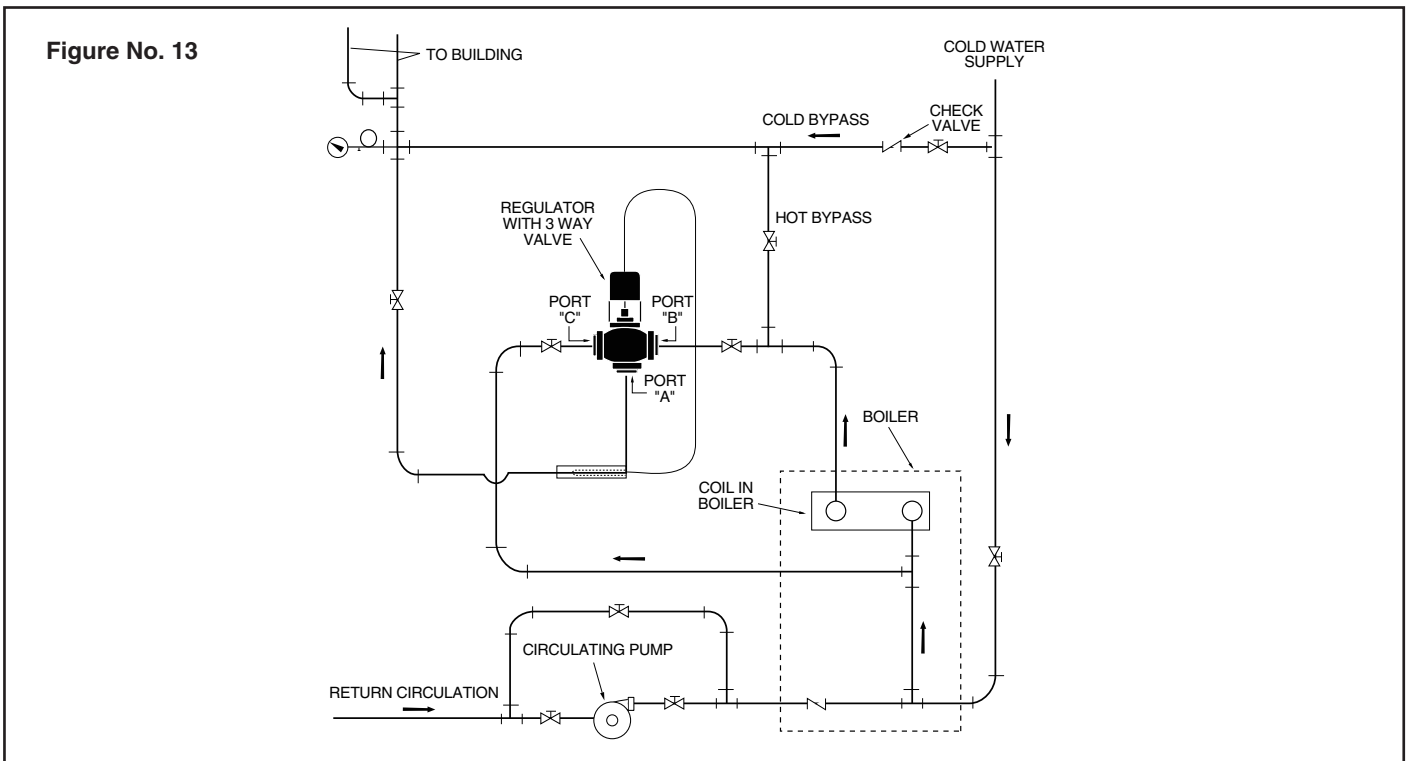

WHEN IN NEED OF INFORMATION

When contacting the factory or one of its representatives in regard to a regulator, be sure to give all the name plate information, fastened to the bellows housing. This name plate is shown in Figure No. 14.



Figure No. 14

START UP PROCEDURE

1. Make sure inlet gate valve is closed.
2. Open outlet gate valve and all equipment drain valves. Allow system to drain completely.
3. Make sure bypass globe valve (if provided) is tightly closed.
4. Release any spring force on temperature adjusting knob. Knob should be at the lowest temperature setting for initial system startup.
5. Slightly open inlet valve (just enough to allow steam or water into regulator). Do not allow pressure to build up. On three-way valves open cold water supply first, then open hot water supply.
6. Allow system to stabilize.
7. Open inlet valve more.
8. Allow system to stabilize.
9. **Check for leaks.**
10. Close drain valves after system is hot and drain valves are blowing steam (indication that all condensate has been removed), or that water valves are passing water.
11. Open inlet valve until about half open. If there are no problems, open completely.
12. Slowly increase the spring tension by turning the adjusting knob until the desired temperature is reached. Allow the system to stabilize (15–30 minutes). Recheck temperature setting.



CAUTION: HEARING PROTECTION IS REQUIRED IF DRAIN VALVES ARE OPEN TO ATMOSPHERE.

Troubleshooting:

Temperature Regulating

Problem:

1. System Temperature is Low.

- a. **Cause:** Low inlet pressure.
Solution: Fully open supply valve. Clean strainer. Check for low boiler output or upstream blockage and make necessary corrections.
- b. **Cause:** Capillary has kink. Sharp bend will stop signal to pilot.
Solution: Replace actuator or work out kink by hand.
- c. **Cause:** Actuator range is incorrect. The actuator will not operate beyond its range.
Solution: Check indicator dial for correct temperature range. Replace if necessary.
- d. **Cause:** Temperature adjustment altered.
Solution: Readjust to desired operating condition.
- e. **Cause:** Main valve undersized.
Solution: Check valve capacity against the load. If insufficient, increase valve size.
- f. **Cause:** Piping flow restricted.
Solution: Calculate the flow velocity and expected friction loss. If excessive, larger inlet and outlet piping are necessary.

Steam Valve Only

- g. **Cause:** Condensate not draining.
Solution: Check steam trap for proper sizing and operation. Trap should drain by gravity into a vented return line. Avoid lifts in the return lines.
- h. **Cause:** Improper stem adjustment.
Solution: Check stem travel by following instruction no. 8 on page 7.
- i. **Cause:** Improper thermostatic bulb location.
Solution: Bulb must be fully into fluid flow being controlled. Use reducer bushing instead of reducers and nipples. In storage tanks install the bulb near the center of the tank. There must be flow past the thermostatic bulb. As a rule of thumb a recirculating pump should provide a minimum of 20% design load at all times.
- j. **Cause:** Poor temperature response.
Solution: On units with separable well use high temperature grate between the thermostatic bulb and well for better heat transfer.
- k. **Cause:** Thermostatic bulb installed upside down.
Solution: See Figure No. 5 and follow bulb installation instructions on page 3.

Problem:

2. System Temperature High

- a. **Cause:** Bypass gate valve is open.
Solution: Close the valve.
- b. **Cause:** Capillary has kink. Sharp bend will stop signal to pilot.
Solution: Replace actuator or work out by hand.
- c. **Cause:** Actuator range incorrect. The actuator will not operate beyond its range.
Solution: Check name plate for correct temperature range. Replace if necessary.
- d. **Cause:** Temperature adjustment altered.
Solution: Readjust to desired operating condition.
- e. **Cause:** Oversized valve.
Solution: Check valve capacity against the load. If excessive, install smaller valve. Steam valves—install a steam pressure reducing valve to reduce capacity.
- f. **Cause:** Improper stem adjustment.
Solution: Check stem travel by following instruction no. 8 on page 7.
- g. **Cause:** Improper thermostatic bulb location.
Solution: Bulb must be fully into the flow path. Use reducing bushing instead of reducing coupling and nipples. In storage tanks install the bulb near the center of the tank. There must be flow past the thermostatic bulb, as a rule of thumb a recirculating pump should provide a minimum of 20% design load at all times.
- h. **Cause:** Poor temperature response.
Solution: On units with separable well use high temperature grease between the thermostatic bulb and well for better heat transfer.
- i. **Cause:** Thermostatic bulb installed upside down.
Solution: See Figure No. 5 and follow bulb installation instructions on page 3.

Problem:

3. System Temperature Erratic

- a. **Cause:** Thermostatic bulb installed upside down.
Solution: The bulb mounting flange has the word top stamped in the O.D. This must be in the up position. The bulb may also be installed vertically with bulb end down, flange on top.
- b. **Cause:** Capillary has kink or defective actuator. Sharp bend will stop signal to pilot.
Solution: Replace actuator or work out by hand.
- c. **Cause:** Thermostatic bulb installed in poor location.
Solution: Install as close as possible to thermometer and heater coils in instantaneous heaters.
- d. **Cause:** Insufficient circulation through heater.
Solution: Check circulation system, and insure sufficient circulation.

Steam Valve Only

- e. **Cause:** Condensate not draining.
Solution: Check steam trap for proper sizing and operation. Trap should drain by gravity into a vented return line. Avoid lifts in the return lines.
- f. **Cause:** Improper stem adjustment.
Solution: Check stem travel per instructions in this manual.

TYPICAL INSTALLATIONS

Figure No. 15— Controlling steam coil in storage tank

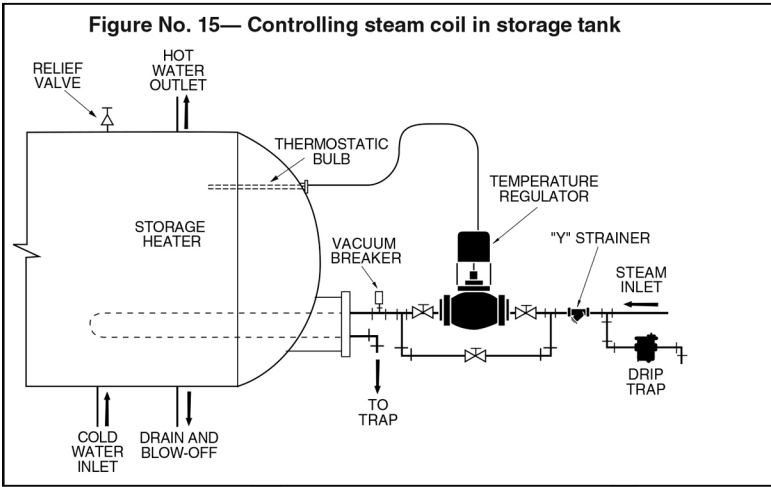

Figure 19 — Controlling oil cooler

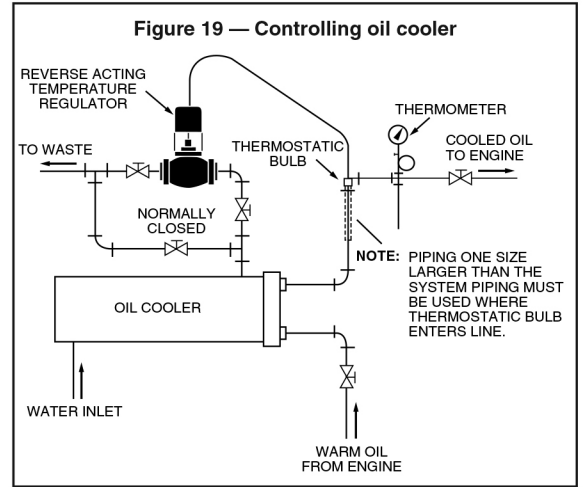

Figure No. 16 — Controlling instantaneous water heater with or without buffer storage tank.

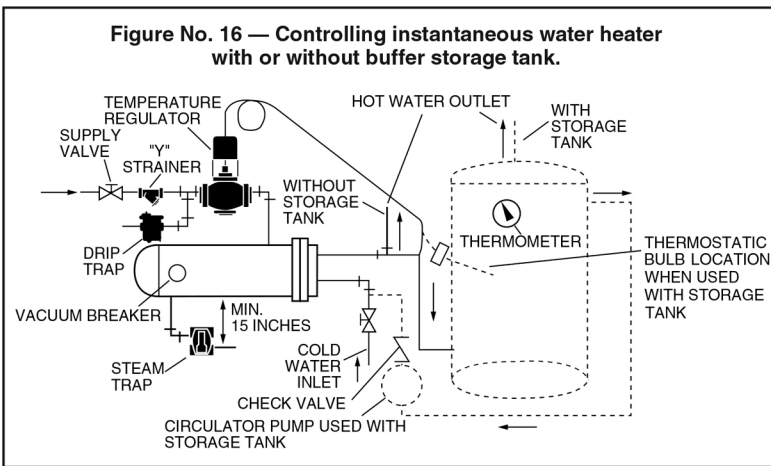

Figure 20 - Controlling storage tank temperature with a diverting valve and heat exchanger

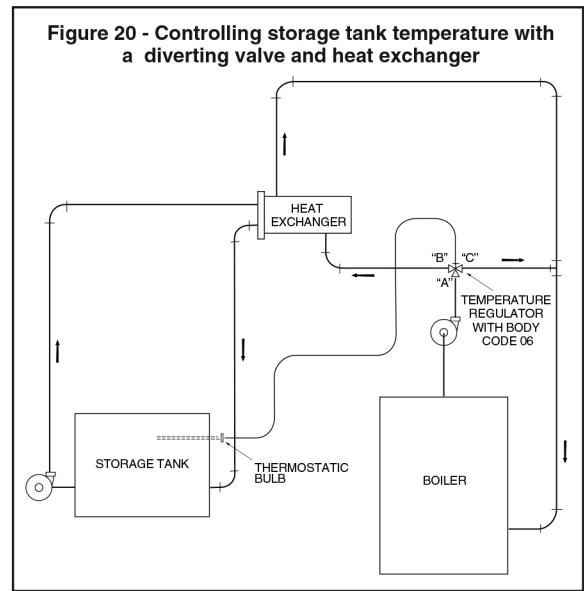

Figure No. 17 — Controlling steam table

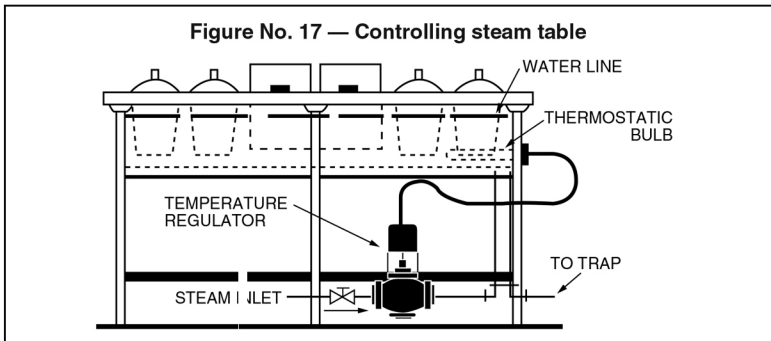

Figure 18 — Controlling hot water plus tempered water at a lower temperature

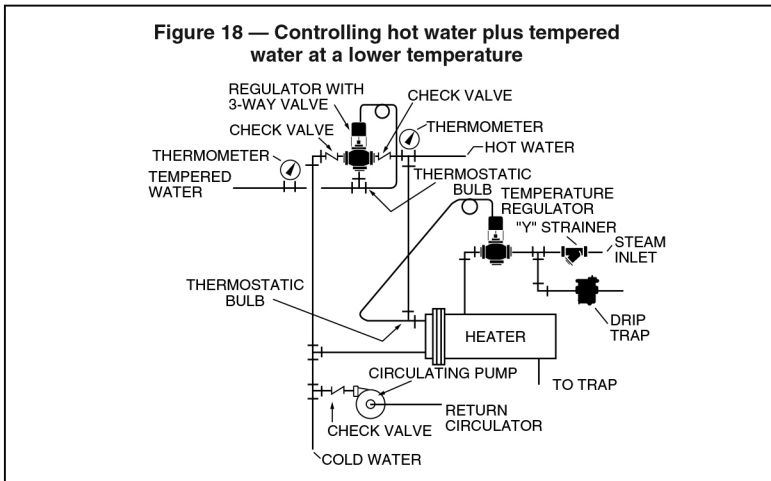
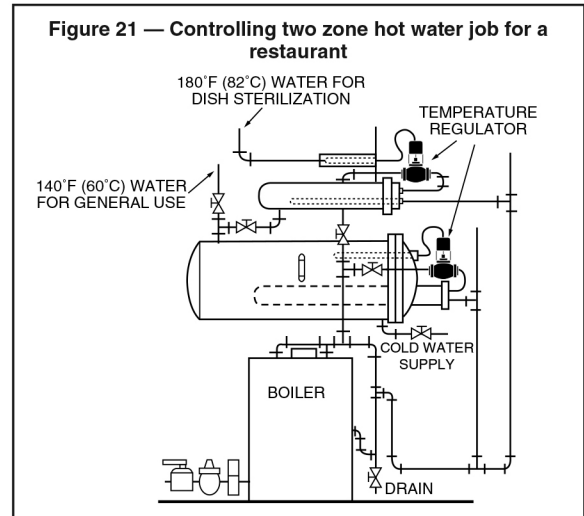

Figure 21 — Controlling two zone hot water job for a restaurant



COMMERCIAL WARRANTY

Warranty. For goods sold to commercial buyers, Seller warrants the goods sold to Buyer hereunder (with the exception of membranes, seals, gaskets, elastomer materials, coatings and other “wear parts” or consumables all of which are not warranted except as otherwise provided in the quotation or sales form) will be (i) be built in accordance with the specifications referred to in the quotation or sales form, if such specifications are expressly made a part of this Agreement, and (ii) free from defects in material and workmanship for a period of one (1) year from the date of installation or two (2) years from the date of manufacture, whichever shall occur first, unless a longer period is specified in the product documentation (the “Warranty”).

Except as otherwise required by law, Seller shall, at its option and at no cost to Buyer, either repair or replace any product which fails to conform with the Warranty provided Buyer gives written notice to Seller of any defects in material or workmanship within ten (10) days of the date when any defects or non-conformance are first manifest. Under either repair or replacement option, Seller shall not be obligated to remove or pay for the removal of the defective product or install or pay for the installation of the replaced or repaired product and Buyer shall be responsible for all other costs, including, but not limited to, service costs, shipping fees and expenses. Seller shall have sole discretion as to the method or means of repair or replacement. Buyer's failure to comply with Seller's repair or replacement directions shall terminate Seller's obligations under this Warranty and render the Warranty void. Any parts repaired or replaced under the Warranty are warranted only for the balance of the warranty period on the parts that were repaired or replaced. Seller shall have no warranty obligations to Buyer with respect to any product or parts of a product that have been: (a) repaired by third parties other than Seller or without Seller's written approval; (b) subject to misuse, misapplication, neglect, alteration, accident, or physical damage; (c) used in a manner contrary to Seller's instructions for installation, operation and maintenance; (d) damaged from ordinary wear and tear, corrosion, or chemical attack; (e) damaged due to abnormal conditions, vibration, failure to properly prime, or operation without flow; (f) damaged due to a defective power supply or improper electrical protection; or (g) damaged resulting from the use of accessory equipment not sold or approved by Seller. In any case of products not manufactured by Seller, there is no warranty from Seller; however, Seller will extend to Buyer any warranty received from Seller's supplier of such products.

THE FOREGOING WARRANTY IS EXCLUSIVE AND IN LIEU OF ANY AND ALL OTHER EXPRESS OR IMPLIED WARRANTIES, GUARANTEES, CONDITIONS OR TERMS OF WHATEVER NATURE RELATING TO THE GOODS PROVIDED HEREUNDER, INCLUDING WITHOUT LIMITATION ANY IMPLIED WARRANTIES OF MERCHANTABILITY AND FITNESS FOR A PARTICULAR PURPOSE, WHICH ARE HEREBY EXPRESSLY DISCLAIMED AND EXCLUDED. EXCEPT AS OTHERWISE REQUIRED BY LAW, BUYER'S EXCLUSIVE REMEDY AND SELLER'S AGGREGATE LIABILITY FOR BREACH OF ANY OF THE FOREGOING WARRANTIES ARE LIMITED TO REPAIRING OR REPLACING THE PRODUCT AND SHALL IN ALL CASES BE LIMITED TO THE AMOUNT PAID BY THE BUYER FOR THE DEFECTIVE PRODUCT. IN NO EVENT SHALL SELLER BE LIABLE FOR ANY OTHER FORM OF DAMAGES, WHETHER DIRECT, INDIRECT, LIQUIDATED, INCIDENTAL, CONSEQUENTIAL, PUNITIVE, EXEMPLARY OR SPECIAL DAMAGES, INCLUDING BUT NOT LIMITED TO LOSS OF PROFIT, LOSS OF ANTICIPATED SAVINGS OR REVENUE, LOSS OF INCOME, LOSS OF BUSINESS, LOSS OF PRODUCTION, LOSS OF OPPORTUNITY OR LOSS OF REPUTATION.

LIMITED CONSUMER WARRANTY

Warranty. For goods sold for personal, family or household purposes, Seller warrants the goods purchased hereunder (with the exception of membranes, seals, gaskets, elastomer materials, coatings and other “wear parts” or consumables all of which are not warranted except as otherwise provided in the quotation or sales form) will be free from defects in material and workmanship for a period of one (1) year from the date of installation or two (2) years from the product date code, whichever shall occur first, unless a longer period is provided by law or is specified in the product documentation (the “Warranty”).

Except as otherwise required by law, Seller shall, at its option and at no cost to Buyer, either repair or replace any product which fails to conform with the Warranty provided Buyer gives written notice to Seller of any defects in material or workmanship within ten (10) days of the date when any defects or non-conformance are first manifest. Under either repair or replacement option, Seller shall not be obligated to remove or pay for the removal of the defective product or install or pay for the installation of the replaced or repaired product and Buyer shall be responsible for all other costs, including, but not limited to, service costs, shipping fees and expenses. Seller shall have sole discretion as to the method or means of repair or replacement. Buyer's failure to comply with Seller's repair or replacement directions shall terminate Seller's obligations under this Warranty and render this Warranty void. Any parts repaired or replaced under the Warranty are warranted only for the balance of the warranty period on the parts that were repaired or replaced. The Warranty is conditioned on Buyer giving written notice to Seller of any defects in material or workmanship of warranted goods within ten (10) days of the date when any defects are first manifest.

Seller shall have no warranty obligations to Buyer with respect to any product or parts of a product that have been: (a) repaired by third parties other than Seller or without Seller's written approval; (b) subject to misuse, misapplication, neglect, alteration, accident, or physical damage; (c) used in a manner contrary to Seller's instructions for installation, operation and maintenance; (d) damaged from ordinary wear and tear, corrosion, or chemical attack; (e) damaged due to abnormal conditions, vibration, failure to properly prime, or operation without flow; (f) damaged due to a defective power supply or improper electrical protection; or (g) damaged resulting from the use of accessory equipment not sold or approved by Seller. In any case of products not manufactured by Seller, there is no warranty from Seller; however, Seller will extend to Buyer any warranty received from Seller's supplier of such products.

THE FOREGOING WARRANTY IS PROVIDED IN PLACE OF ALL OTHER EXPRESS WARRANTIES. ALL IMPLIED WARRANTIES, INCLUDING BUT NOT LIMITED TO THE IMPLIED WARRANTIES OF MERCHANTABILITY AND FITNESS FOR A PARTICULAR PURPOSE, ARE LIMITED TO ONE (1) YEAR FROM THE DATE OF INSTALLATION OR TWO (2) YEARS FROM THE PRODUCT DATE CODE, WHICHEVER SHALL OCCUR FIRST. EXCEPT AS OTHERWISE REQUIRED BY LAW, BUYER'S EXCLUSIVE REMEDY AND SELLER'S AGGREGATE LIABILITY FOR BREACH OF ANY OF THE FOREGOING WARRANTIES ARE LIMITED TO REPAIRING OR REPLACING THE PRODUCT AND SHALL IN ALL CASES BE LIMITED TO THE AMOUNT PAID BY THE BUYER FOR THE DEFECTIVE PRODUCT. IN NO EVENT SHALL SELLER BE LIABLE FOR ANY OTHER FORM OF DAMAGES, WHETHER DIRECT, INDIRECT, LIQUIDATED, INCIDENTAL, CONSEQUENTIAL, PUNITIVE, EXEMPLARY OR SPECIAL DAMAGES, INCLUDING BUT NOT LIMITED TO LOSS OF PROFIT, LOSS OF ANTICIPATED SAVINGS OR REVENUE, LOSS OF INCOME, LOSS OF BUSINESS, LOSS OF PRODUCTION, LOSS OF OPPORTUNITY OR LOSS OF REPUTATION.

Some states do not allow limitations on how long an implied warranty lasts, so the above limitation may not apply to you. Some states do not allow the exclusion or limitation of incidental or consequential damages, so the above exclusions may not apply to you. This warranty gives you specific legal rights, and you may also have other rights which may vary from state to state.

To make a warranty claim, check first with the dealer from whom you purchased the product or call +1-847-966-3700 for the name and location of the nearest dealer providing warranty service.

xylem
Let's Solve Water

Xylem Inc.
8200 N. Austin Avenue
Morton Grove, Illinois 60053
Phone: (847) 966-3700
Fax: (847) 965-8379
www.xylem.com/bellgossett



Bell & Gossett is a trademark of Xylem Inc. or one of its subsidiaries.
© 2019 Xylem Inc. HS-5041 May 2019 Part No. 517031