

INSTRUCTION MANUAL

S14367
REVISION C



INSTALLER: PLEASE LEAVE THIS MANUAL FOR THE OWNER'S USE.

Technologic® Constant Speed Pump Controller



NOTE: The information contained in this manual is intended to assist operating personnel by providing information on the characteristics of the purchased equipment.

It does not relieve the user of the responsibility to adhere to local codes and ordinances and the use of accepted practices in the installation, operation and maintenance of this equipment.

Further information pertaining to the installation, operation and maintenance of your Technologic Constant Speed Pump Controller can be found in the instruction manuals for the associated equipment provided. See Section 1.1, Maintenance, for a list of relevant manuals.

Table of Contents

Section 1 — General

1.1	Purpose of Manual	6
1.2	Safety	6
1.2.1	Safety Alert Symbol	6
1.2.2	Safety Instruction Decal	6
1.2.3	Hazardous Voltage	6
1.2.4	Pump/Motor Safety	6
1.2.5	Closed System Safety Measures	6
1.3	Storage	6
1.4	Handling	7
1.5	Foundation	7
1.6	Leveling	7
1.7	Location	7
1.8	Piping	7
1.9	Temperature and Ventilation	7
1.10	Incoming Power and Ground Wiring	7

Section 2 — Operator Interface Panel

2.1	Key Functionality	8
2.2	LEDs	8
2.3	I/O	9
2.3.1	Analog Inputs	9
2.3.2	Powered Analog Inputs.....	9
2.3.3	RTD Inputs	9
2.3.4	Digital Inputs	9
2.3.5	Relay and Power Monitor Rack	10
2.3.5.1	Digital Output Module	10
2.3.5.2	Power Measurement Module	10
2.3.5.3	Current Transformer	10

Section 3 — Operation

3.1	Power-Up	10
3.2	Basics of Screen Navigation and User Setup	10
3.3	Pump Operation.....	11
3.3.1	Manual Pump Operation	11
3.3.2	Automatic Pump Operation	11
3.4	Status Screens	11
3.4.1	Tech Status.....	11
3.4.2	Pump Status	11
3.4.3	Sensor Status.....	12
3.4.4	Staging	12
3.4.5	Timers	12
3.4.6	Power	12

3.4.7	Optional Sensors	13
3.5	Alarms/Events	13
Section 4 — Setup Menu		
4.1	Sensor Setup	15
4.2	Pump Setup Menu.....	15
4.2.1	Number of Pumps	15
4.2.2	Pump Nameplate Data	15
4.3	System Setup Menu	16
4.3.1	Stage Menu	16
4.3.1.1	Primary Staging	16
4.3.1.2	Secondary Staging	17
4.3.1.3	Force Destage/Minimum Pump Run Time	17
4.3.2	Alternation	17
4.3.3	Pump Exercise	18
4.3.4	Start/Stop	18
4.3.5	Scheduling	19
4.3.6	Date/Time	19
4.3.7	Password	19
4.3.8	Relay Outputs Setup.....	19
4.3.9	Save/Load Menu	20
4.3.9.1	Save to Flash	20
4.3.9.2	Load from Flash.....	20
4.3.9.3	Load Defaults	20
4.3.10	Communications	20
4.3.10.1	BACnet MS/TP	20
4.3.10.2	Metasys N2.....	21
4.3.10.3	Modbus	21
4.3.10.4	Lonworks.....	21
4.3.10.5	Analog Input Override	22
4.3.11	Tech 350	22
4.4	Test Menu	22
4.4.1	Digital Input Test	22
4.4.2	Digital Output Test.....	22
4.4.3	Analog Input Test	22
4.4.4	LED Test	22
4.4.5	Key Test	23
4.4.6	Display Test	23
4.4.7	Comm Test	23
4.5	Alarms/Events Menu.....	23
4.5.1	Pump Failure	23
4.5.2	Low System Pressure	23

4.5.3	High System Pressure	24
4.5.4	Low Suction Pressure	24
4.5.5	High Suction Pressure	24
4.5.6	No Flow Shutdown	25
4.5.7	High Temperature Cutout	25
4.5.8	Low Level	26
4.5.9	Volts Tolerance	26
4.6	EZ-Start	26
4.7	Log Menu	27
4.7.1	Alarm Log	27
4.7.2	Pump Log Menu	27
4.7.2.1	Pump State Log	27
4.7.2.2	Pump Runtime Log	27
4.7.2.3	Reset Pump Runtime	27
4.7.3	Data Log	27
4.7.4	Data Log Rate	28
4.7.5	Operation Log Menu	28
4.7.5.1	Operation Mode Changes Log	28
4.7.5.2	Power Cycles Log	28
4.7.5.3	Events Log	28
4.7.5.4	Purge Log	28
4.7.5.5	Exercise Log	29
4.7.5.6	Operating Hours	29
4.7.6	Totals	29
4.7.7	Reset Totals	29
4.7.8	Log Book	29
Section 5 — Maintenance		
5.1	Battery	30
5.2	Signal Generator (analyzer) - recommended	30
5.3	Field Repair	30
5.4	Program Updating	30
5.5	Info Screens	30
5.6	Troubleshooting	31
Section A — Parameter List		32
Section B — BACnet Protocol Implementation Conformance Statement for BACnet MS/TP		35
Section C — Serial Communications Points		37
Section D — Procedure for Field Balancing 70E/70M PRVs		39
Section E — Electrical Wiring and Control Settings – Final Check List		39
Section F — System Piping and Unit Installation - Final Check List		40
Section G — Quick Startup Check List		40
Section H — Drawings		42

Section 1 — General

1.1 Purpose of Manual

This manual describes the operation of the Technologic® Constant Speed Pump Controller for control of constant speed pump systems.

The control panel consists of an operator interface panel (OIP), a disconnect switch, control transformer, motor starters, motor branch circuit protection including fuses or circuit breakers and thermal overloads, a 24VDC power supply, and terminal blocks for customer connections.

Further information pertaining to the system can be found in the following IOMs:

1. Bell & Gossett 1510 # P81673
2. Bell & Gossett 1531 # P81567
3. CLA-VAL Pressure Reducing Valve # TM90-01
4. McDonnell & Miller Series 750B and 750BM Conductance Actuated Level Controls # MM-248(C)
5. McDonnell & Miller FS250 General Purpose Liquid Flow Switch # MM-625
6. Square D Differential Pressure Switches # 65013-009-32C
7. United Electric Controls 54 Series Pressure Switches # IMP54-03

1.2 Safety

1.2.1 Safety Alert Symbol

**SAFETY INSTRUCTION**

This safety alert symbol will be used in this manual to draw attention to safety related instructions. When used, the safety alert symbol means **ATTENTION, BECOME ALERT! YOUR SAFETY IS INVOLVED! FAILURE TO FOLLOW THIS INSTRUCTION MAY RESULT IN A SAFETY HAZARD.**

1.2.2 Safety Instruction Decal

Your Technologic® Constant Speed Pump Controller should have a safety instruction decal (part # S11550) located on the front of the enclosure near the disconnect switch. If the decal is missing or illegible contact your local B&G representative for a replacement.

1.2.3 Hazardous Voltage

Only qualified electricians should perform electrical service of any kind on the control panel or pumping system. Visually inspect the control panel for loose or stranded wires and for damaged components or wires prior to performing electrical service. Never troubleshoot or perform service on a live control panel. Do not turn the disconnect switch on while the enclosure door is open. Live voltage is still connected to the incoming side of the disconnect switch even when the

disconnect switch is off. Turn off and lock out the incoming power prior to troubleshooting or performing service on this control panel.

**WARNING: High Voltage!** Do not work on live control panels. Disconnect the incoming power prior to performing service on this unit. **FAILURE TO FOLLOW THIS INSTRUCTION MAY RESULT IN DEATH OR PROPERTY DAMAGE.**

1.2.4 Pump/Motor Safety

All electrical installation or service on the motors should be performed by a qualified electrician. Ground fault protection should be sized properly. Refer to local electrical codes for sizing and selection. Refer to the I.O.M. for the motors for specific installation information. Even when the Pumps are stopped, they should be considered alive as long as its controller is energized. Keep hands away from the pumps until the power is disconnected from the pump controller.

1.2.5 Motor Control Equipment Safety

Do not install and operate a pumping package in a closed system unless the system is constructed with properly sized safety and control devices. Such devices include the use of properly sized and located pressure relief valves, compression tanks, pressure controls, temperature controls and flow controls as appropriate. If the system does not include these devices, consult the responsible engineer or architect before making pumps operational.

**DANGER:** The heating of water and other fluids causes volumetric expansion. The associated forces may cause failure of system components and release of high temperature fluids. This will be prevented by installing properly sized and located pressure relief valves and compression tanks. **FAILURE TO FOLLOW THESE INSTRUCTIONS CAN RESULT IN SERIOUS PROPERTY DAMAGE AND SERIOUS PERSONAL INJURY OR DEATH.**

1.3 Storage

For long periods of storage, the pumping package should be covered to prevent corrosion and contamination from dirt. It should be stored in a clean, dry location between -20 and +60° C. The relative humidity should not exceed 95%. The unit should be checked periodically to ensure that no condensation has formed. After storage, check that it is dry before applying power.

1.4 Handling

Care should be taken to prevent damage due to dropping or jolting when moving any panel or pumping package. Transportation damage should be brought to the carrier's attention immediately upon receipt.

The unit should be unloaded and handled by qualified personnel. A pumping package that includes this panel may be top heavy due to the position of the motors. Lift the unit with slings placed under the unit base rails. Be sure not to load the lifting mechanism beyond its rated limits. Use the motor eyebolts to stabilize the unit while lifting to prevent overturning.

 **DANGER:** Heavy load, may drop if not lifted properly. Do not load cables, chains or hoists beyond their rated limits. **FAILURE TO FOLLOW THESE INSTRUCTIONS COULD RESULT IN SERIOUS PERSONAL INJURY, DEATH AND/OR PROPERTY DAMAGE.**

1.5 Foundation

A concrete base weighing at least 2.5 times the weight of the pumping package is recommended. Check the shipping ticket for the unit weight. Tie the concrete pad in with the finished floor. Use foundation bolts and larger pipe sleeves to give room for final bolt location.

1.6 Leveling

Place the pumping package on its concrete foundation, supporting it with steel wedges or shims totaling 1" in thickness. These wedges or shims should be put on both sides of each anchor-bolt to provide a means of leveling the base.

1.7 Location

Install the pumping package appropriately for ease of inspection, maintenance and service. Observe local electrical codes concerning control panel spacing.

1.8 Piping

Be sure to eliminate any pipe strain on the pumping package. Support all pipes independently by use of pipe hangers near the unit. Ordinary wire or band hangers are not adequate to maintain alignment. It is very important to provide a strong, rigid support for the suction and discharge lines. A saddle hanger is recommended. Do not attempt to force the suction or discharge lines into position. Refer to the assembly drawing for customer piping connections.

Inspect all unit piping connections. Joints may also become loose during transit due to vibration and shock. All joints should be checked for tightness. Flanged joints should be checked for proper torque of all flange bolts prior to filling the system with fluid.

Eccentric increasers may be used in the suction lines when increasing the pipe size, with the straight sides of the increaser on top to eliminate air pockets.

For critical installations, equipment for absorbing expansion and vibration should be installed in the inlet and outlet connections of the unit.

Drain plugs are placed in a cloth bag and secured to the unit prior to shipping from the factory. Reinstall the drain plugs prior to filling the system with fluid.

On an open system with a suction lift, use a foot valve of equal or greater area than the pump suction piping. Prevent clogging by using a strainer at the suction inlet next to the foot valve. The strainer should have an area three times that of the suction pipe. Provisions must be made to prime the pump suction piping on start up. Do not start the pump unless all suction piping is full of water.

A thermal relief valve is installed on the discharge header to prevent potentially dangerous thermal buildup in the package. This valve acts as a safety device and it should never be removed or tampered with. It is factory set to open and discharge when the water temperature in the discharge header exceeds 125°F. The 3/8" NPT opening of this valve must be piped to a floor drain.

Before starting, all pumps and motors should be checked for proper lubrication.

1.9 Temperature and Ventilation

The operating temperature range for this unit is 0 to 50°C. The relative should be kept between 10% and 90% non-condensing. The unit should not be operated outside these extremes.

1.10 Incoming Power and Ground Wiring

A qualified electrician should bring incoming power and ground wiring to the disconnect switch. If holes are drilled in the control panel, be sure to not contaminate electrical components with metal filings. A grounding terminal is provided next to the disconnect switch for an incoming ground wire connection. Wire types and sizes must be selected according to the National Electrical Code and all local codes and restrictions. Refer to the input current and voltage as listed on the nameplate on the enclosure door when sizing the power wires. Only copper (Cu) wire rated for 75°C (minimum) may be used for the power connections. The voltage tolerance is +10/-5% and phase to phase voltage must not have an imbalance greater than 5 VAC.

 **WARNING:** Prevent electrical shocks. Disconnect the incoming power supply to the control panel before beginning installation. **FAILURE TO FOLLOW THESE INSTRUCTIONS MAY RESULT IN DEATH OR PROPERTY DAMAGE.**

 **WARNING:** Conduit grounds are not adequate. A separate ground wire must be attached to the ground lug provided in the enclosure to avoid potential safety hazards. **FAILURE TO FOLLOW THESE INSTRUCTIONS COULD RESULT IN SERIOUS PERSONAL INJURY, DEATH AND/OR PROPERTY DAMAGE.**

Section 2 — Operator Interface Panel

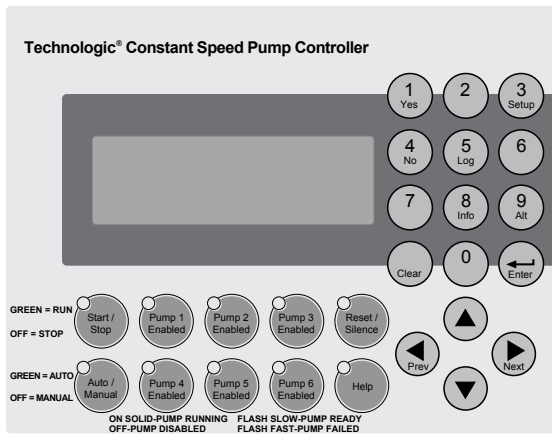

The OIP consists of a 4 x 20 character LCD screen and a 26 button keypad with LEDs which display system status. It also is equipped with onboard I/O including (16) 24VDC digital inputs, (4) 4-20mA analog inputs, (2) PT100 RTD inputs, and an RS232/RS485 serial port for communications all mounted on the back of the OIP. The OIP communicates through a CAN bus to the relay and power monitor rack.

2.1 Key Functionality

The names of the keys on the Operator Interface Panel (OIP) are shown as CAPITAL LETTERS in this manual. Table 1 shows the functionality of the keys on the OIP.

Note: The contrast can be adjusted from any screen by pressing the UP and DOWN arrows while holding the ENTER key.

Key Name	Functionality
START/STOP	Starts or stops the system. When the Start/Stop method is not “Keypad”, pressing the START/STOP key will toggle between “Ready” and “Stop”. “Ready” indicates the system is waiting for a remote signal to start.
AUTO/MANUAL	Toggles the operation mode. The system must be stopped to change the operation mode.
PUMP 1-6 ENABLE	Enables or disables the corresponding pump. Pumps cannot be disabled while they are failed.
RESET/SILENCE	This key is used to reset pumps and alarms. When the A/V Alarm relay output (section 4.3.8) is set, initial pressing of this key opens the relay to silence the horn or turn off the pilot light. Pressing a second time resets the pumps and alarms.

Key Name	Functionality
HELP	Press the HELP button, from the status screens, to view alarms or events while the HELP LED is flashing. While in the Alarm screen, press the HELP button again to view help messages for active alarms. Press HELP any other time to view screen specific help messages.
YES/1	Press YES at OK prompts to accept values and proceed
SETUP/3	Press SETUP, from the status screens, to bring up the Setup Menu shown in section 4
NO/4	Press NO at OK prompts to edit the parameters
LOG/5	Press LOG, from the status screens, to bring up the Log Menu, shown in section 4.7
INFO/8	Press INFO, from the status screens, to bring up the Info screens, shown in section 5.5
ALT/9	Press ALT, from the status screens, to manually alternate the pump staging sequence, see section 4.3.2
ENTER	Confirms entries
CLEAR	Clears entries or used to exit some screens
PREV (←)	Navigates to neighboring screens
NEXT (→)	Navigates to neighboring screens
UP (↑)	Used to modify values and navigate to neighboring screens
DOWN (↓)	Used to modify values and navigate to neighboring screens

Table 1: Key Functionality

2.2 LEDs

Table 2 gives the meaning of the LED states.

LED	Description
START/STOP	On = Start Off = Stop Blink Slow = Ready (waiting for remote method)
AUTO/MANUAL	On = Auto Off = Manual
PUMP 1-6	On = Pump On Off = Pump Disabled Blink Slow = Pump Ready Blink Fast = Pump Failed
RESET/SILENCE	Off = OK Blink Slow = Reset Required Blink Fast = A/V Alarm output is active
LED	Description
HELP	Off = OK Blink Slow = Event (press HELP from the status screens to view) Blink Fast = Alarm (press HELP from the status screens to view)

Table 2: LED Functionality

2.3 I/O

2.3.1 Analog Inputs

The Technologic® Constant Speed Pump Controller is equipped with 4 analog input channels. The analog inputs must provide a 4-20mA signal. Typically, analog inputs will be powered by the 24V power supply within the panel. For analog inputs which source their own power, see the following section. See section 4.1 for more information on sensor setup.

Shielded 22 AWG cable should be installed for all analog input wiring. The shield must be terminated in the Technologic® Constant Speed Pump Controller. Do not connect the shield at the other end of the cable! Insulate the shield so that no electrical connection is made at the other end of the cable. A twisted pair of #22 AWG conductors can be used in place of shielded cable. The cable length must be limited to 5,000 feet for #22 AWG wire.

2.3.2 Powered Analog Inputs

The following steps describe the general procedure for wiring an analog input when the sensor's power source is not the Technologic® Constant Speed Pump Controller.

 **WARNING:** Prevent electrical shocks. Disconnect the power supply before beginning installation. **FAILURE TO FOLLOW THESE INSTRUCTIONS COULD RESULT IN SERIOUS PERSONAL INJURY, DEATH AND/OR PROPERTY DAMAGE.**

- 1) Turn off all power to the Technologic® Constant Speed Pump Controller.
- 2) Refer to the appropriate controller wiring diagram that was shipped with unit. Locate the analog input sensors on the wiring diagram that will be rewired. They are labeled AI1 – AI4.
- 3) Remove the 24 VDC positive (+) wire from TB 40 for the respective analog input sensor connection. This wire needs to be removed completely or terminated if used as a jumper. This will prevent any accidental contact with a negative (-) voltage source (i.e. control panel) and avoid becoming a short circuit. Care should be taken to ensure that 24 VDC positive (+) voltage is still provided to any remaining sensors that will be powered by the Technologic® Constant Speed Pump Controller.
- 4) Remove the 24 VDC negative (-) wire from TB 41 for the respective analog input sensor connection. This wire needs to be removed completely or terminated if used as a jumper. This will prevent any accidental contact with a positive (+) voltage source and avoid becoming a short circuit. Care should be taken to ensure that 24 VDC (-) negative voltage is still provided to any remaining sensors that will still be powered by the Technologic® Constant Speed Pump Controller.
- 5) Terminate the negative (-) wire of the sensor to TB 41 of the respective analog input sensor connection. Terminate the positive (+) wire of the sensor to the terminal block which is connected to the positive (+) terminal shown on the Analog input card.

Note: Be certain that the power supplied to other terminal blocks has not been interrupted! The wires that were removed in the preceding steps may have been used as jumpers.

2.3.3 RTD Inputs

The Technologic® Constant Speed Pump Controller is equipped with (2) PT100 RTD input channels. (2) RTDs will be shipped with standard units. The system RTD will be factory mounted, on the suction header, unless the control panel is sold separate from the pump package. The suction RTD will be shipped loose inside the control panel and will need to be field mounted upstream of the suction header.

2.3.4 Digital Inputs

The Technologic® Constant Speed Pump Controller is equipped with (16) 24VDC digital input channels. This signal voltage must be obtained from the 24VDC power supply mounted to the subpanel. It is not recommended that other power sources be used without factory approval. All digital inputs are automatically assigned based on Table 3. See the typical wiring diagram in Appendix H.

Functionality	DI #	Description
1M-6M Feedback	1-6	Motor starter feedbacks (generate overload alarm)
Start/Stop Sw	7	Remote contact can be used to start/stop the system. The start/stop method must be set to Remote. See section 4.3.4. “Rem” will be displayed in the Tech Status screen shown in section 3.4.1 when this method is active.
Flow Switch	8	Used for no flow shut-down, see section 4.5.6.
Pressure Sw	9	Used to detect low suction pressure alarm or event, see section 4.5.4.
Low Level	10	Low level relay to sense a low level condition in a tank. All pumps will stop when active.
DP 1-6	11-16	Differential pressure switches

Table 3: Digital Inputs Functionalities

22 AWG cable should be installed for all field wiring to digital inputs.

2.3.5 Relay and Power Monitor Rack

The relay and power monitor rack consists of an EX270 CAN bus controller, a DO722 digital output module and an AI984 power measurement module.

2.3.5.1 Digital Output Module

The digital output module consists of 8 normally open single pole single throw relays rated at 2.5A at either 240VAC or 24VDC. One relay will be used to energize the coil of each motor starter. These will be factory wired. Customer connections are made directly to the terminals mounted on the digital output module. If a relay is defective, the digital output module must be replaced. Refer to section 4.3.8 for relay output setup.

2.3.5.2 Power Measurement Module

The power measurement module calculates total power by measuring the incoming voltage and the total current from the current transformer.

2.3.5.3 Current Transformer

The current transformer (ct) comes in three different sizes measuring up to 40A, 150A, or 400A. It plugs directly into the AI984 module on the relay and power monitor rack. The ct measures the total amp draw of all motors in the system. The four digit hex numbers displayed on the label on the current transformer are calibration values, unique to each ct, that have been input into the controller prior to shipment. See section 5.5 to view the values used.

Section 3 — Operation

3.1 Power-Up

Turn the disconnect switch “ON” to power up the controller.



WARNING: Electrical shock hazard.

Inspect all electrical connections prior to powering the unit. Wiring connections must be made by a qualified electrician in accordance with all applicable codes, ordinances and good practices. **FAILURE TO FOLLOW THESE INSTRUCTIONS COULD RESULT IN SERIOUS PERSONAL INJURY, DEATH AND/OR PROPERTY DAMAGE.**

In order to recover from a power loss, the controller will start up in the operating mode that it was in prior to the last shutdown. On power up, the controller will display the Tech Status screen shown in section 3.4.1.

3.2 Basics of Screen Navigation and User Setup

Numeric inputs (represented by the # symbol) must be input from the numeric keypad. Text fields (represented by the \$ symbol) must be modified by using the UP and DOWN arrow keys. For numeric or text fields, ENTER must be pressed to confirm values.

The arrow keys are also used to navigate to neighboring screens. Flashing arrows shown on the display indicate when the corresponding arrow keys are active.

An OK prompt is used in most user setup screens. Press NO (the number 4 key) followed by ENTER at the OK prompt to edit the parameters shown, or press YES (the number 1 key) followed by ENTER to accept the values and exit the screen.

The YES/1 and NO/4 keys are also used for text inputs for some parameters. They will appear as “Y” or “N” when a text input is required.

The CLEAR key is also used to exit some screens including: Log screens, Test screens, Info screens, and the Alarm screen.

3.3 Pump Operation

The pumps can be controlled manually or automatically. See the following sections for instructions on both types of operation.

3.3.1 Manual Pump Operation

To manually control the pumps with the controller, the operation mode must be set to Manual by pressing the AUTO/MANUAL key. Note that this key is not allowed unless the system is stopped. The Auto/Manual LED will be off to indicate manual operation. The system must also be started by pressing the START/STOP key. The Start/Stop LED will be on to indicate the system is started.

Pumps are automatically disabled when operation mode is changed to manual. Press the corresponding PUMP ENABLE keys to start or stop pumps. The corresponding LED will turn solid green to indicate a pump is on.

3.3.2 Automatic Pump Operation

To automatically control the pumps with the controller, the operation mode must be set to Auto by pressing the AUTO/MANUAL key. Note that this key is not allowed unless the system is stopped. The Auto/Manual LED will be on to indicate automatic operation. The system must also be started by pressing the START/STOP key. The Start/Stop LED will be on to indicate the system is started.

During automatic pump operation, the pumps will turn on or off based on the primary staging method. If more pumps are required to meet the system demand, they will stage on as required. When the system demand is met, and the minimum pump run timer is met, the pumps will destage until only one pump is running. When there is no demand in the system, the no flow shutdown alarm or event will occur, shutting down the last running pump. During this sequence, alarms may occur that shut down a specific pump or all of the pumps. Various automatic pump alternation methods may be used to alternate the pump sequence at any time.

View the status screens, shown in section 3.4, to get system information including on/off or auto/manual status, pump status, sensor values, or staging status.

3.4 Status Screens

The status screens are the main level in screen navigation and show most of the relevant system information. The status screens can be scrolled by pressing PREV or NEXT.

The Setup Menu(3), Log Menu(5), Info screens(8), Manual Alternation screen(9), and Alarm screen(HELP) are only accessible from the status screens.

All of the status screens will display “Alm”, “Evt”, or “NFSD” in the lower right corner if an alarm or event or NFSD condition exists. If this message is flashing, press the HELP key for more details.

3.4.1 Tech Status

The Tech Status screen, shown below, is the first of the status screens. This screen is displayed on power up. See Table 4 below for a description of the Tech Status variables.

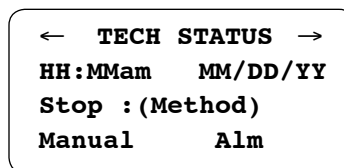

Variable	Description
Start/Stop/Ready	Stop: System is stopped. Pumps will not start. Start: System is started. The pumps can be controlled manually or automatically. Ready: System is waiting for remote start/stop method, see section 4.3.4. Press the START/STOP button to toggle.
Method	System Start/Stop Method, see section 4.3.4. Key: Keypad Rem: Remote contact Sch: Scheduled start/stop Ser: Serial Communications
Auto/Manual	Manual: System is in manual operation mode. The user can manually start and stop the pumps by pressing the corresponding Pump On/Off key. Auto: The system is in automatic operation mode. The pumps will be controlled automatically based on the user setup info. Press the AUTO/MANUAL key to toggle.

Table 4: Tech Status Variables

3.4.2 Pump Status

Pressing NEXT, the controller will display the Pump Status screen shown below. See Table 5 for a description of the Pump Status variables.

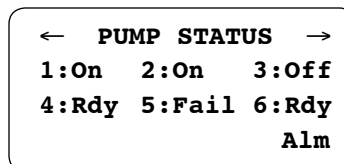

Variable	Description
P1-P6	On: pump is running Off: pump is disabled from the keypad Rdy: pump is enabled but not running Fail: pump is failed

Table 5: Pump Status Variables

3.4.3 Sensor Status

Pressing NEXT, the controller will display the Sensor Status screen shown below. See Table 6 for a description of the Sensor Status variables.

```

← Suc Press= ### →
Sys Press= ###
Suc Temp=###.#
Sys Temp=###.# Alm
    
```

Variable	Units	Description
Suc Press	PSI	Suction Pressure
Sys Press	PSI	System (discharge) Pressure
Suc Temp	°F	Suction Temperature (mounted upstream of the suction header)
Sys Temp	°F	System Temperature (mounted on the suction header)

Table 6: Sensor Status Variables

3.4.4 Staging

Pressing NEXT, the controller will display the Staging screen shown below. See Table 7 for a description of the Staging variables.

```

← STAGING: (Type) →
Stg Seq:1-2-3-4-5-6
Dstg: ##### Stg: #####
Actual: ###.# Alm
    
```

Variable	Description
Type	Type will display the active staging method.
Stg Seq	Pump staging sequence from left to right. A 0 indicates that a pump is failed or disabled. See section 4.3.2 for information on alternating the staging sequence.
Stg	Next staging value (N/A indicates end of staging sequence or no staging values set up)

Variable	Description
Dstg	Next destaging value (N/A indicates end of destaging sequence or no destaging values set up)
Actual	Current value of the staging variable

Table 7: Staging Variables

Note: “Stg” and “Dstg” will be displayed in units of the active staging method shown in the “Type” field. To change the staging type or values, see section 4.3.1.

3.4.5 Timers

Pressing NEXT, the controller will display the Timers screen shown below. The numeric values on the left are elapsed times, and the numeric values on the right are the limits that they must reach prior to performing their respective action. See Table 8 for a description of the Staging variables.

```

← Pump MnRn:##/##m →
NFSD MnRn:###/###m
Stg PT:##/##
Dstg PT:##/## Alm
    
```

Variable	Units	Description
Pump Min Run	Minutes	Pump minimum run time, see section 4.3.1.3. When the timer reaches its limit pumps will be allowed to destage.
NFSD MnRn	Minutes	No flow shutdown minimum run time, see section 4.5.6. When the timer reaches its limit, a no flow shutdown will be allowed to occur. Note that the timer immediately resets to zero after expiring.
Stg PT	Seconds	Staging proof timer, see section 4.3.1.1. When the timer reaches its limit, another pump will stage on.
Dstg PT	Seconds	Destaging proof timer, see section 4.3.1.1. When the timer reaches its limit, a pump will stage off.

Table 8: Timers Variables

3.4.6 Power

Pressing NEXT, the controller will display the Power screen shown below.

```

← POWER →
HP= ###.# PF= #.#
Volts= ###.#
Amps = ###.# Alm
    
```

Variable	Units	Description
HP	Horse-power	Total power measured by the power module
Volts	Volts	Average voltage measured by the power module
Amps	Amps	Total current measured by the power module
PF	N/A	Power factor measured by the power module

Table 9: Power Variables

3.4.7 Optional Sensors

Pressing NEXT, the controller will display the Optional Sensors screen shown below if any optional sensors are set up. If they are not, the Optional Sensors screen will be skipped. See section 4.1 for information on sensor setup.

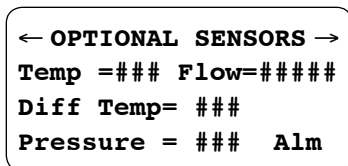

Variable	Units	Description
Temp	°F	Optional temperature
Diff Temp	°F	Optional differential temperature
Pressure	PSI	Optional pressure
Flow	GPM	Optional flow

Table 10: Optional Sensor Variables

3.5 Alarms/Events

Some conditions can be defined as alarms or events, while others are predefined to be alarms. See section 4.5 for alarm setup. Alarms are logged in the Alarm Log and events are logged in the Events Log. See section 4.7 for logging. An alarm triggers the General Alarm serial communications point and the A/V Alarm relay output. An event will not trigger either of these. See Appendix C for the serial communications points list and section 4.3.8 for relay outputs setup.

Some alarms or events will cause one or all of the pumps to shut down. For Low System Pressure, the user can define if the pumps will shut down or not.

All alarms or events require either a manual or automatic reset. The RESET/SILENCE LED will flash when a manual reset is required. Press the RESET key to manually reset the system.

The values in parentheses in Table 11 are the default values.

Description	Alarm or Event	Pump Shutdown	Reset	Conditional Upon	Help Message
Pump 1-6 DP Fail	Alarm	Individual	Manual	Started	Check DP switch, impeller, coupler, motor
Pump 1-6 Overload Fail	Alarm	Individual	Manual	Started	Check motor amp draw and use manual reset if ok
Low System Pressure	User Defined (Event)	User Defined (No)	Auto always active, Manual reset is allowed if Stop Pumps or Alarm is set to "Y"	Started and Auto	Check PRV setting and trip point
High System Pressure	Alarm	Yes	Manual	Started and Auto	Check PRV setting and trip point
Low Suction Pressure (AI)	User Defined (Event)	Yes	Manual always active, auto reset is allowed if "Auto Reset" is set to "Y"	Started and Auto	Check suction pressure and trip point
Low Suction Pressure (Sw)	User Defined (Event)	Yes	Manual always active, auto reset is allowed if "Auto Reset" is set to "Y"	Started and Auto	Check suction pressure and trip point
High Suction Pressure	User Defined (Event)	Yes	Auto	Started and Auto	Check suction pressure and trip point
No Flow Shut Down (AI)	User Defined (Event)	Yes	Auto	Started and Auto and only 1 pump on	NFSD is active, check restart pressure
No Flow Shut Down (Sw)	User Defined (Event)	Yes	Auto	Started and Auto and only 1 pump on	NFSD is active, check restart pressure
High Temperature	Alarm	Yes	Auto	Started and Auto	Check water temperature and trip point
Low Level	Alarm	Yes	Auto	Started and Auto	Check water level in holding tank
AI 1-4 Fail	Alarm	No	Auto	Always active	Check wiring, piping, polarity and continuity
RTD 1-2 Fail	Alarm	No	Auto	Always active	Check wiring and continuity
Battery	Alarm	No	Auto	Always active	Replace OIP battery
CAN Fail	Alarm	No	Auto	Always active	Set EX270 switches C (top), 2 (bottom), check wiring
Volt Tol.	Alarm	Yes	Auto	Always active	Check voltage reading and trip point
Voltage	Alarm	No	Auto	Always active	Check AI984 connection and voltage inputs

Table 11: Alarms/Events

The LED on the HELP key will flash to indicate that an alarm or event exists. The Status screens will also flash "Alm", "Evt", or "NFSD" in the lower right corner to indicate that an alarm or event exists. Pressing the HELP key, while in the status screens, will display all of the active alarms or events as shown in the screen below. Blinking arrows will indicate UP/DOWN can be pressed to view more alarms or events. Press CLEAR to exit this screen, or press HELP again while in the Alarms screen to view help messages for each alarm.

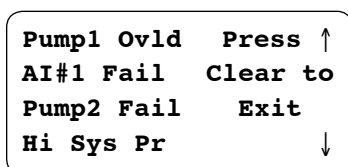

Section 4 — Setup Menu

From the status screens, shown in section 3.4, press the SETUP key to get to the Setup Menu shown below. Field values columns are provided to record user setup information for future reference. For the remainder of this manual, the path to navigate to a particular screen will be given as follows: Path: Status Screens/Setup(3).

```

Setup Menu: # 0=Exit
1=Sensors 4=Test
2=Pumps 5=Alrm/Evt
3=System 6=EZ-Start
    
```

4.1 Sensor Setup

Path: Status Screens / Setup (3) / Sensors (1)

```

← Sensor Setup →
AI#:# (Type)
Span= #### Zero=####
OK? $ (Y/N)
    
```

While the left and right arrows are flashing, press PREV or NEXT to scroll through all of the analog inputs and RTDs that can be set up. Press UP/DOWN to modify the sensor type when it is flashing. Input the span (the sensor value that corresponds to a 20mA signal), then input the Zero (the sensor value that corresponds to a 4mA signal). Table 12 shows the default values for each analog input or RTD. Table 13 shows all of the possible analog input or RTD types.

Sensor Number	Default Type	Default Span	Default Zero	Field Type	Field Span	Field Zero
AI #1	Suc Press	100	0			
AI #2	Sys Press	300	0			
AI #3	None	0	0			
AI #4	None	0	0			
RTD #1	Suc Temp	N/A	N/A			
RTD #2	Sys Temp	N/A	N/A			

Table 12: Sensor Setup Variables

Analog Input Types	RTD Types
None	None
Suc Press	Suc Temp
Sys Press	Sys Temp
Flow	Sup Temp
Temp	Ret Temp
Press	
Diff Temp	

Table 13: Possible Sensor Types

Note: Only one sensor of each type can be set up. If a type is chosen that is already used for another sensor or RTD channel, the other sensor or RTD input will be given a type of “None”.

4.2 Pump Setup Menu

Path: Status Screens / Setup (3) / Pumps (2)

```

Pump Menu: # 0=Exit
1=Number of Pumps
2=Nameplate Data
3=Reset Pmp Runtime
    
```

4.2.1 Number of Pumps

Path: Status Screens / Setup (3) / Pumps (2) / Number of Pumps(1)

```

Total # Pumps: #
# Jockey Pumps: #
# Standby Pumps: #
OK? $ (Y/N)
    
```

See Table 14 for a description of the variables.

Variable	Description	Default Value	Range	Field Value
Total # Pumps	The total number of pumps in the system.	3	1-6	
# Jockey Pumps	Jockey pumps will always be first in the staging sequence. Alternation will not change this designation. Jockey Pumps will be assigned to the lowest pump numbers starting with Pump # 1.	0	0-5	
# Standby Pumps	A standby pump will only operate if a duty pump fails. The last pumps in the staging sequence will be designated as the standby pumps.	0	0-5	

Table 14: Number of Pumps Variables

4.2.2 Pump Nameplate Data

Path: Status Screens / Setup (3) / Pumps (2) / Nameplate Data (2)

```

← Pump# 1 Data →
HP : ###.#
Amps: ###.#
GPM : ##### OK? $
    
```

Press PREV or NEXT to scroll through all of the pumps. See Table 15 for a description of the variables.

Variable	Description	Default Value	Range	Field Value
HP	Enter the horsepower from the nameplate of the motor. These values are required for power staging.	Actual	0 - 999.9	
Amps	Enter the full load amps from the motor nameplate. These values are required for amps staging.	0	0 - 999.9	
GPM	Enter the maximum GPM from the pump nameplate. These values are required for flow staging.	0	0 - 999.9	

Table 15: Pump Nameplate Data Variables

Note: All values will be copied to the next screen by pressing NEXT. They will only be copied the first time the screens are visited.

4.3 System Setup Menu

Path: Status Screens / Setup (3) / System (3)

```

System Menu: #      ↑
0=Exit
1=Staging
2=Alternation      ↓
    
```

```

System Menu: #      ↑
3=Exercise
4=Start/Stop
5=Scheduling      ↓
    
```

```

System Menu: #      ↑
6=Date/Time
7=Password
8=Relay Outputs   ↓
    
```

```

System Menu: #      ↑
9=Save/Load
*10=Communications
*11=Tech 350     ↓
    
```

Press UP/DOWN to view the entire menu.

*Note: depending on factory setup, menu items 10 and 11 may or may not be available

4.3.1 Stage Menu

Path: Status Screens/Setup(3)/System(3)/Staging(1)

```

Stage Menu:#  0=Exit
1=Primary Staging
2=Secondary Staging
3=Force Dstg/Min Run
    
```

4.3.1.1 Primary Staging

Path: Status Screens / Setup (3) / System (3) / Staging (1) / Primary Staging (1)

```

Pri Stg Mthd: Method
Stg :###(U)  PT: ##s
Dstg:###(U)  PT: ##s
Dynamic Stg:$ OK? $
    
```

See Table 16 for a description of the Primary Staging variables

Variable	Units	Description	Default Value	Range	Field Value
Pri Stg Mthd	N/A	Primary staging method. Power, Amps, and flow staging require nameplate data to be set up. See section 4.2.2.	Power	Power, Amps, Press, D Temp, Flow, Temp	
Stg	(U)	The value at which pumps will stage on. The units depend on the staging type. This is the stage 1-2 value and will be used for each staging occurrence unless Dynamic Stg is set to "Y".	80	0-999	
Dstg	(U)	The value at which pumps will stage off. The units depend on the staging type. This is the destage 2-1 value and will be used for each destaging occurrence unless Dynamic Stg is set to "Y".	72	0-999	
PT	Seconds	The proof timer that will elapse before staging pumps on/off.	5	5-99	
Dynamic Stg	N/A	Select "Y" for Dynamic Stg to choose different staging and destaging values for each staging occurrence. A separate screen will be displayed to allow for these inputs.	N	Y/N	

Table 16: Primary Staging Variables

If "Y" was selected for Dynamic Stg, the screen shown below will be displayed.

```

← Method Value Time →
Stg1-2:  ###(U)  ##s
Dst2-1:  ###(U)  ##s
          OK? $ (Y/N)
    
```

The staging method chosen will be displayed in the upper left corner. Press PREV or NEXT to scroll through each staging occurrence. The staging numbers will increment to indicate which occurrence is being shown. Set the value and the proof time for each staging occurrence.

4.3.1.2 Secondary Staging

Path: Status Screens / Setup (3) / System (3) / Staging (1) / Secondary Staging (2)

Sec Stg Mthd: Method
Stg :###(U) PT: ##s
Dstg:###(U) PT: ##s
Dynamic Stg:\$ OK? \$

See Table 17 for a description of the Secondary Staging variables

Variable	Units	Description	Default Value	Range	Field Value
Sec Stg Method	N/A	Secondary staging method. This will be used if the sensor for the primary method fails. Power, Amps and flow staging require nameplate data to be set up. See section 4.2.2.	Pressure	Power, Amps, Press, D Temp, Flow, Temp	
Stg	(U)	The value at which pumps will stage on. The units depend on the staging type. This is the stage 1-2 value and will be used for each staging occurrence unless Dynamic Stg is set to "Y".	System Pressure - 10	0-999	
Dstg	(U)	The value at which pumps will stage off. The units depend on the staging type. This is the destage 2-1 value and will be used for each destaging occurrence unless Dynamic Stg is set to "Y".	System Pressure - 3	0-999	
PT	Sec-onds	The proof timer that will elapse before staging pumps on/off.	5	5-99	
Dynamic Stg	N/A	Select "Y" for Dynamic Stg to choose different staging and destaging values for each staging occurrence. A separate screen will be displayed to allow for these inputs.	"N"	Y/N	

Table 17: Secondary Staging Variables

If "Y" was selected for Dynamic Stg, the screen shown below will be displayed.

← Method Value Time →
Stg1-2: ###(U) ##s
Dst2-1: ###(U) ##s
OK? \$ (Y/N)

The staging method chosen will be displayed in the upper left corner. Press PREV or NEXT to scroll through each staging occurrence. The staging numbers will increment to indicate which occurrence is being shown. Set the value and the proof time for each staging and destaging occurrence.

4.3.1.3 Force Destage/Minimum Pump Run Time

Path: Status Screens / Setup (3) / System (3) / Staging (1) / Force Dstg / Min Run (3)

Force Dstg/Min Run
Force Dstg Tmr=##Min
Min Run Timer =##Min
OK? \$ (Y/N)

See Table 18 for a description of the Force Destage/Minimum Pump Run Time variables.

Variable	Units	Description	Default Value	Range	Field Value
Force Dstg Tmr	Min-utes	Maximum time a lag pump will run prior to destaging automatically, a value of 0 disables forced destaging. See section 3.4.5 for display of timer status.	60	0-99	
Min Run Timer	Min-utes	Minimum time a lag pump must run prior to destaging, a value of 0 effectively disables the minimum run timer. See section 3.4.5 for display of timer status.	5	0-99	

Table 18: Force Destage/Minimum Pump Run Time Variables

4.3.2 Alternation

Path: Status Screens / Setup (3) / System (3) / Alternation (2)

Alt Method: \$\$\$\$\$
Basis:\$\$\$\$\$ Dur:##s
Time:##:## Day: ##
Period:###Hrs OK? \$

The pump staging sequence, which is shown in section 3.4.4, may be alternated automatically or manually. To manually alternate the sequence, press ALT from the status screens, then press “Y” and ENTER at the prompt. Automatic and manual alternation methods use the Basis and Dur variables shown below. See Table 19 for a description of the Alternation variables.

Variable	Units	Description	Default Value	Range	Field Value
Alt	N/A	Automatic Alternation Method None: disables automatic alternation Timed: alternates based on the “Period” Daily: alternates daily based on the “Time” Weekly: alternates weekly based on the “Time” and the “Day” Monthly: alternates monthly based on the “Time” and the “Day”	None	None, Timed, Daily, Weekly, Monthly	
Basis	N/A	Seq: the next pump in the sequence will become the lead pump after alternation Pmp Tm: the pump with the lowest run time will become the lead pump after alternation	Seq	Seq, Pmp Tm	
Dur	Sec- onds	Amount of time that the running pumps will remain on during alternation	10	0-99	
Time	N/A	Time, in 24hr format, at which the pumps will be alternated for daily, weekly, or monthly alternation	0:00	0:00-23:59	
Day	N/A	Day of the week (1=Monday...7=Sunday) or month (day of month) on which the pumps will be alternated	1	1-28	
Period	Hours	Time between pump alternations when using “Timed” alternation	168	0-999	

Table 19: Alternation Variables

4.3.3 Pump Exercise

Path: Status Screens / Setup (3) / System (3) / Exercise (3)

```

Pump Exercise
Period : ###Hr
Duration : ###Sec
OK? $
    
```

Pump exercising will ensure that no pumps go for long periods of time without running. Note that automatic alternation can also provide this functionality. Pump exercising will only occur when the system is started and in automatic operation. All pumps which need exercising will exercise on startup. All exercising events will be logged in the Exercise Log shown in section 4.7.5.5. See Table 20 for a description of the Exercise variables.

Variable	Units	Description	Default Value	Range	Field Value
Period	Hours	Amount of time between automatic exercising of the pumps, a value of 0 disables pump exercising	0	0-999	
Duration	Sec- onds	Amount of time pumps will be exercised, all pumps which have not run in the last period will be exercised simultaneously	0	0-999	

Table 20: Pump Exercise Variables

4.3.4 Start/Stop

Path: Status Screens / Setup (3) / System (3) / Start / Stop (4)

```

Start/Stop
Method: $$$$$$$$
OK? $
    
```

The controller can be started or stopped in a variety of ways. This method will always be displayed next to the start/stop/ready status in the Tech Status screen shown in section 3.4.1. See Table 21 for a description of the Start/Stop Methods.

Variable	Description	Default Value	Range	Field Value
Method	Keypad: Use the keypad to start and stop the system Remote: Use “Start/Stop Sw” tied to DI #7 Serial: Use “System Start/Stop” shown in appendix C Scheduled: Use scheduling to start and stop the system, see section 4.3.5	Keypad	Keypad, Remote, Serial, Scheduled	

Table 21: Start/Stop Variables

Note: When the Start/Stop Method is anything other than “Keypad”, the START/STOP key must be pressed to set the system “Ready” prior to using the desired method. When the chosen method is active, the START/STOP key can be pressed to start or stop the system. If the chosen method is inactive, the Start/Stop Method must be set back to “Keypad” to start the system from the keypad.

4.3.5 Scheduling

Path: Status Screens / Setup (3) / System (3) / Scheduling (5)

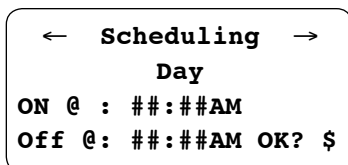

Press PREV or NEXT to change the day for which scheduling will be set up. See Table 22 for a description of the Scheduling variables.

Variable	Description
ON @	Time at which the system will automatically start. Set the hour to 0 to prevent the system from starting on this day.
Off @	Time at which the system will automatically stop. Set the hour to 0 to prevent the system from stopping on this day.
AM/PM	Press UP/DOWN to select AM/PM

Table 22: Scheduling Variables

Note: Scheduling must be set up as the start/stop method, for it to take effect. See section 4.3.4 for more information on the start/stop method. Also, the controller must be powered up at the specified times, or it will remain in the previous state until the next scheduled on or off time.

4.3.6 Date/Time

Path: Status Screens / Setup (3) / System (3) / Date/Time (6)

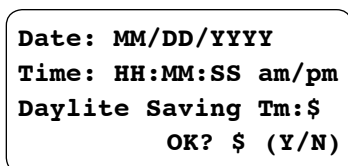

See Table 23 for a description of the Date/Time Setup variables.

Variable	Description
MM	Current month (two digits), example: Jan. should be created as 01
DD	Current date (two digits), example: the 6th should be entered as 06
YYYY	Current year using all 4 digits
HH	Hours
MM	Minutes
am/pm	Use UP/DOWN to toggle am/pm
Daylite Saving Tm	Enter “Y” for automatic set back during daylight saving time.

Table 23: Date/Time Variables

4.3.7 Password

Path: Status Screens / Setup (3) / System (3) / Password (7)

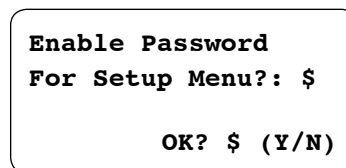

If the above is set to YES, the user will be prompted to input a password prior to entering the Setup Menu. Upon exiting the above screen, the user will be prompted to define and confirm a new password. The password must be a numeric value (0-99999). Record it here or somewhere else!

4.3.8 Relay Outputs Setup

Path: Status Screens / Setup (3) / System (3) / Relay Outputs (8)

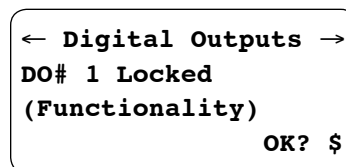

Press PREV or NEXT to scroll through the digital outputs. Its output number and functionality will be displayed. If a digital output is “Unlocked”, it may be modified. Use UP or DOWN to modify the functionality. Multiple outputs may have the same functionality.

Functionality	Description
1M-6M Output	Relay used to energize motor starter coil or can be used as pump run status
General Alarm	Relay closes to indicate an “alarm” condition exists (will not indicate an “event”)
System On	Relay closes when the system is started
System Auto	Relay closes when the system is in automatic mode
A/V Alarm	Relay closes to indicate an “alarm” condition exists (will not indicate an “event”), this output is intended to be connected to a pilot light or a horn. When this output is active, the RESET/SILENCE LED will blink fast to indicate it should be pressed to deactivate this output. Once this output is deactivated, the RESET/SILENCE key will function normally to reset pumps and alarms.

Table 24: Optional Digital Outputs

Note: 1M-6M outputs will be automatically assigned to digital outputs according to the appropriate wiring diagram depending on the number of pumps that are set up. These outputs will always be “locked” and cannot be modified.

4.3.9 Save/Load Menu

Path: Status Screens / Setup (3) / System (3) / Save/Load (9)

Sav/Ld Menu:# 0=Exit
1=Save to Flash
2=Load from Flash
3=Load Defaults

4.3.9.1 Save to Flash

Path: Status Screens / Setup (3) / System (3) / Save/Load (9) / Save to Flash (1)

PREVIOUS SAVED
DATA WILL BE
OVERWRITTEN!
Proceed? \$

Press YES and ENTER to save all of the user setup to the flash memory. Saving to flash will overwrite any data that was previously saved. A load from flash will have to be performed to recover this saved data. See the following section.

4.3.9.2 Load from Flash

Path: Status Screens / Setup (3) / System (3) / Save/Load (9) / Load from Flash (2)

ALL USER SETUP
DATA WILL BE
LOADED FROM FLASH
Proceed? \$

Press YES and ENTER to overwrite all of the current user setup information with the data that was previously saved to the flash memory.

4.3.9.3 Load Defaults

Path: Status Screens / Setup (3) / System (3) / Save/Load (9) / Load Defaults (3)

ALL USER SETUP
DATA WILL BE
OVERWRITTEN BY
DEFAULTS! Proceed? \$

Press YES and ENTER to overwrite all of the current user setup information with the factory defaults.

4.3.10 Communications

Selecting 10 from the System Setup Menu will display the appropriate communications setup screen shown in the following sections. If no communications were set up by the factory, this menu option will not be available. If the communication type displayed is not the type of communications desired, call your Bell & Gossett representative for assistance in changing it.

Refer to Appendix C for the list of serial communications points that are available for each protocol.

4.3.10.1 BACnet MS/TP

Path: Status Screens / Setup (3) / System (3) / BACnet (10)

Enable BACnet: \$
Baud, 8, 1, 1, N Slave
MAC=### Inst=###
AI Ovr: \$ OK? \$

The Technologic® Constant Speed Pump Controller communicates using 8 bit data packets, 1 stop bit, 1 start bit and no parity. See the Protocol Implementation Conformance statement in appendix D for details on the supported objects and services.

Variable	Description	Default Value	Range	Field Value
Enable BACnet	This must be set to “Y” to utilize RS-485 communications. It should only be set to “N” to upload software upgrades.	Y	Y/N	
Baud	The baud rate is user adjustable	9600	9600, 19200, 38400	
MAC Address	The MAC address or node number should be supplied by the BMS.	10	1-255	
Inst	Unique instance numbers should be assigned for every device on a BACnet network.	100	0-9999	
AI Ovrđ	Select “Y” to override analog inputs through the communications port. See section 4.3.10.5.	N	Y/N	

Table 25: BACnet MS/TP Variables

4.3.10.2 Metasys N2

Path: Status Screens / Setup (3) / System (3) / JC N2 (10)

Enable Metasys N2: \$
9600,8,1,1,N VND
Node=###
AI Ovrđ: \$ OK?\$

See Table 26 for a description of the Metasys N2 variables.

The Technologic® Constant Speed Pump Controller communicates using 9600 bps baud rate, 8 bit data packets, 1 stop bit, 1 start bit and no parity.

Variable	Description	Default Value	Range	Field Value
Enable Metasys N2	This must be set to “Y” to utilize RS-485 communications. It should only be set to “N” to upload software upgrades.	Y	Y/N	
Node	The node number should be supplied by the BMS.	10	0-255	
AI Ovrđ	Select “Y” to override analog inputs through the communications port. See section 4.3.10.5.	N	Y/N	

Table 26: Metasys N2 Variables

4.3.10.3 Modbus

Path: Status Screens / Setup (3) / System (3) / Modbus (10)

Enable Modbus: \$
9600,8,1,1,N VND
Node=###
AI Ovrđ: \$ OK?\$

See Table 27 for a description of the Modbus variables.

The Technologic® Constant Speed Pump Controller communicates using 9600 bps baud rate, 8 bit data packets, 1 stop bit, 1 start bit and no parity.

Variable	Description	Default Value	Range	Field Value
Enable Modbus	This must be set to “Y” to utilize RS-485 communications. It should only be set to “N” to upload software upgrades.	Y	Y/N	
Node	The node number should be supplied by the BMS.	10	0-255	
AI Ovrđ	Select “Y” to override analog inputs through the communications port. See section 4.3.10.5.	N	Y/N	

Table 27: Modbus Variables

4.3.10.4 Lonworks

Path: Status Screens / Setup (3) / System (3) / Lonworks (10)

Enable Lonworks: \$
AI Ovrđ: \$ OK?\$

See Table 28 for a description of the Lonworks variables.

The Technologic® Constant Speed Pump Controller communicates using Modbus over RS-232 media through a gateway, supplied with the panel, which converts the protocol to Lonworks.

Note: Lonworks requires additional hardware.

Variable	Description	Default Value	Range	Field Value
Enable Lonworks	This must be set to “Y” to enable Lonworks communications.	Y	Y/N	
AI Ovrđ	Select “Y” to override analog inputs through the communications port. See section 4.3.10.5.	N	Y/N	

Table 28: Lonworks Variables

4.3.10.5 Analog Input Override

If “Y” was entered for “AI Ovrđ” in any of the communication setup screens above, the following screen will be automatically displayed.

```

AI Override
Suc P:$ D Temp:$
Sys P:$ Press:$
Flow :$ Temp:$ OK?$
    
```

Enter a “Y” next to each analog input type that will be overridden through the communications port.

4.3.11 Tech 350

Path: Status Screens / Setup (3) / System (3) / Tech 350 (11)

```

Tech 350
Purge Time: ##Min
Purge Num Pumps: #
App Type: $$$$ OK?$
    
```

This setup menu will only be available for closed systems. If purging is enabled, purging will occur every time the system is started in automatic mode. Every time purging occurs it will be logged. See section 4.7.5.4 for purge logging. See Table 29 for a description of the Tech 350 variables.

Variable	Units	Description	Default Value	Range	Field Value
Purge Time	Minutes	Time that the pumps will run immediately after starting the system in automatic mode, a value of 0 disables purging	10	0-30	
Number of Pumps	N/A	Number of pumps that will turn on when purging is active	1	0-6	
App Type	N/A	The application type is required if staging will be based on temperature.	Cool	Heat, Cool	

Table 29: Tech 350 Variables

4.4 Test Menu

Path: Status Screens / Setup (3) / Test (4)

```

Test Menu: #
0=Exit 3=AI 6=Disp
1=DI 4=LED 7=Comm
2=DO 5=Key
    
```

Press the numeric key corresponding to the desired sub-menu, and press ENTER.

4.4.1 Digital Input Test

Path: Status Screens / Setup (3) / Test (4) / DI (1)

```

Digital Input Test
1234567890123456
#####
Press Clear to Exit
    
```

The 0 below each corresponding input will change to a 1 upon receiving a 24VDC digital input on that channel. Press CLEAR to exit the test.

4.4.2 Digital Output Test

Path: Status Screens / Setup (3) / Test (4) / DO(2)

```

Digital Output Test
12345678
#####
Enter DO# # (0=Exit)
    
```

Press the numeric key corresponding to the digital output for which the state is to be changed, and then press ENTER to change it. Pressing ENTER multiple times will toggle between 0 and 1. A 1 indicates that the corresponding relay is closed. When the relay is closed, the corresponding LED on the digital output module will be lit. Press 0 and ENTER to exit the test.

Note: Motors will start if the corresponding relay is actuated.

4.4.3 Analog Input Test

Path: Status Screens / Setup (3) / Test (4) / AI (3)

```

Analog Input Test
AI1=###% AI4 =###%
AI2=###% RTD1=###.##F
AI3=###% RTD2=###.##F
    
```

The signal received on the corresponding analog input channel will be indicated in percent next to each input. 0mA = 0%, and 20mA = 100%. Analog inputs 1-4 are 4-20mA inputs. RTD1 and RTD2 are for PT100 resistive temperature devices. RTD1 and RTD2 are displayed in °F. Press CLEAR to exit the test.

4.4.4 LED Test

Path: Status Screens / Setup (3) / Test (4) / LED (4)

```

LED Test
*** LED ON ***
*** LED OFF ***
*** LED BLINK ***
    
```

All of the LED’s on the keypad will turn on, off, and then flash. The current status will be displayed on the screen. The LED test is self terminating.

4.4.5 Key Test

Path: Status Screens / Setup (3) / Test (4) / Key (5)

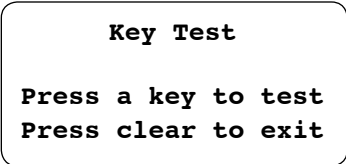

Press any key except for the CLEAR key, and the display will confirm that the key is working by displaying the key name. Press CLEAR to exit.

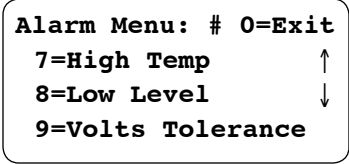
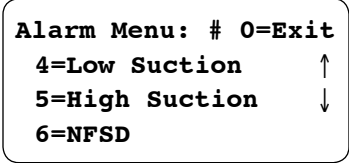

Press UP/DOWN to view the entire menu.

4.4.6 Display Test

Path: Status Screens / Setup (3) / Test (4) / Disp (6)



The display will show all black characters. Press CLEAR to exit.

4.4.7 Comm Test

Path: Status Screens / Setup (3) / Test (4) / Comm (7)

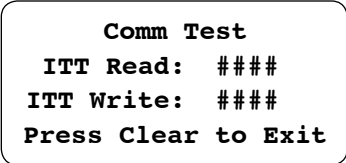

If the controller is communicating properly with the building automation system, both numbers will continue increasing in value. For Modbus protocol, the read and write numbers should be equal and increasing with every poll. For BACnet, both numbers should be increasing, but they will not be equal. The write value will increase even when not connected. For the Metasys N2 protocol, both numbers should be increasing but may not be equal. This test feature is not supported for Lonworks. If both numbers are not increasing in value, the controller is not communicating properly. Check the wiring at the terminal blocks. See section 4.3.10 for more information on communications setup. Press CLEAR to exit this test.

4.5.1 Pump Failure

Path: Status Screens / Setup (3) / Alrm/Evt (5) / Pump Failure (1)

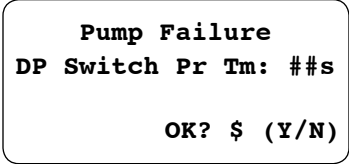

See Table 30 for a description of the Pump Failure variables.

Variable	Units	Description	Default Value	Range	Field Value
DP Switch Pr Tm	Sec-onds	Proof timer prior to setting a pump fail alarm after receiving a continuous high signal from a DP switch	10	0-99	

Table 30: Pump Failure Variables

4.5.2 Low System Pressure

Path: Status Screens / Setup (3) / Alrm/Evt (5) / Low System (2)

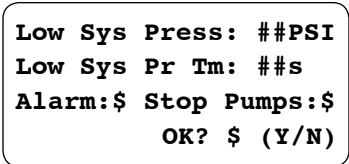

See Table 31 for a description of the Low System Pressure variables.

4.5 Alarms/Events Menu

Path: Status Screens / Setup (3) / Alrm/Evt (5)

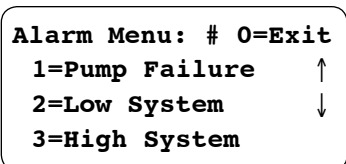

Variable	Units	Description	Default Value	Range	Field Value
Low Sys Press	PSI	The pressure below which an alarm or event will be set	½ System Pressure	0-999	
Low Sys Pr Tm	Sec-onds	The proof timer prior to setting an alarm or event. A value of 0 disables this alarm or event.	0	0-255	
Alarm	N/A	Set this value to “Y” to consider low system pressure an alarm, or set it to “N” to consider it an event.	N	Y/N	
Stop Pumps	N/A	Set this value to “Y” to stop all pumps in the event of a low system pressure alarm or event. Set it to “N” to continue operation normally during this alarm or event.	N	Y/N	

Table 31: Low System Pressure Variables

4.5.3 High System Pressure

Path: Status Screens / Setup (3) / Alrm/Evt (5) / High System (3)

High Sys Press: ##
High Sys Pr Tm: ##s

OK? \$ (Y/N)

See Table 32 for a description of the High System Pressure variables.

Variable	Units	Description	Default Value	Range	Field Value
High Sys Press	PSI	The pressure above which an alarm will be set	1.5 x System Pressure	0-999	
High Sys Pr Tm	Sec-onds	The proof timer prior to setting an alarm. A value of 0 disables this alarm.	20	0-255	

Table 32: High System Pressure Variables

4.5.4 Low Suction Pressure

Path: Status Screens / Setup (3) / Alrm/Evt (5) / Low Suction (4)

Low Suct Press: ##
Pr Tm: ##s Alarm:\$
Auto Reset: \$
Reset Press: ## OK?\$

See Table 33 for a description of the Low Suction Pressure variables.

Variable	Units	Description	Default Value	Range	Field Value
Low Suct Press	PSI	The pressure below which an alarm or event will be set for the analog input method	5	0-999	
Pr Tm	Sec-onds	The proof timer prior to setting an alarm or event. A value of 0 will disable this alarm. Used for analog input and pressure switch methods.	20	0-255	
Auto Reset	N/A	Select “Y” to allow this alarm or event to be automatically reset. The analog input method resets using the “Reset Press”. The pressure switch method resets on a low signal on the low suction pressure switch digital input.	Y	Y/N	
Reset Press	PSI	The pressure at which the controller will automatically reset when the suction pressure rises above it. Used for the analog input method only.	10	0-999	
Alarm	N/A	Set this value to “Y” to consider low suction pressure an alarm, or set it to “N” to consider it an event. Used for analog input and pressure switch methods.	N	Y/N	

Table 33: Low Suction Pressure Variables

Note: The analog input and pressure switch methods can be used simultaneously.

4.5.5 High Suction Pressure

Path: Status Screens / Setup (3) / Alrm/Evt (5) / High Suction (5)

High Suc Press: ##
High Suc Pr Tm: ##s
Reset Pressure: ##
Alarm:\$ OK? \$ (Y/N)

See Table 34 for a description of the High Suction Pressure variables.

Variable	Units	Description	Default Value	Range	Field Value
High Suc Press	PSI	The pressure above which an alarm or event will be set	System Pressure	0-99	
High Suc Pr Tm	Sec-onds	The proof timer prior to setting an alarm or event. A value of 0 disables this alarm.	0	0-255	
Reset Press	PSI	The controller will automatically reset when the suction pressure falls below the "Reset Press"	0.9 times System Pressure	0-999	
Alarm	N/A	Set this value to "Y" to consider high suction pressure an alarm, or set it to "N" to consider it an event.	N	Y/N	

Table 34: High Suction Pressure Variables

Variable	Units	Description	Default Value	Range	Field Value
Min Run Tm	Min-utes	Amount of time for which the NFSD condition will be ignored after restarting the system from a previous NFSD. Used for differential temperature and flow switch methods. See section 3.4.5 for display of timer status.	10	0-999	
Alarm	N/A	Set this value to "Y" to consider NFSD an alarm, or set it to "N" to consider it an event. Used for differential temperature and flow switch methods.	N	Y/N	

Table 35: No Flow Shutdown Variables

4.5.6 No Flow Shutdown

Path: Status Screens / Setup (3) / Alrm/Evt (5) / NFSD (6)

Diff Temp: ##F Alrm: \$
NFSD Pr Tm: ##s
Rstrt PSI: ##PSI
Min Run Tm: ##m OK? \$

See Table 35 for a description of the No Flow Shutdown variables.

Variable	Units	Description	Default Value	Range	Field Value
Diff Temp	°F	Differential temperature limit, between the suction and system temperature sensors, prior to setting a no flow shutdown alarm or event.	5	0-99	
NFSD Pr Tm	Sec-onds	Proof timer prior to setting a NFSD alarm or event. Used for differential temperature and flow switch methods.	10	0-999	
Restrt PSI	PSI	Pressure at which the controller will automatically reset from a NFSD when the system pressure falls below it. Used for differential temperature and flow switch methods.	System Pressure minus 10	0-999	

Note: The analog input method and the flow switch method can be used simultaneously. NFSD will only occur when only one pump is running.

4.5.7 High Temperature Cutout

Path: Status Screens / Setup (3) / Alrm/Evt (5) / High Temp (7)

High Temp: ###F
High Temp Pr Tm: ##s
High Temp Reset: ###F
OK? \$ (Y/N)

See Table 36 for a description of the High Temperature Cutout variables.

Variable	Units	Description	Default Value	Range	Field Value
High Temp	°F	The system temperature above which a High Temperature alarm or event will be set.	125	0-255	
High Temp Pr Tm	Sec-onds	The proof timer prior to setting a high temperature alarm. A value of 0 disables this alarm.	20	0-255	
High Temp Reset	°F	The system temperature below which the high system temperature alarm will be automatically reset.	100	0-255	

Table 36: High Temperature Cutout Variables

4.5.8 Low Level

Path: Status Screens/Setup(3)/Alrm/Evt(5)/Low Level(8)

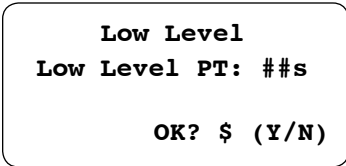

See Table 37 for a description of the Low Level variables.

Variable	Units	Description	Default Value	Range	Field Value
Time	Sec-onds	The proof time prior to setting a low level alarm, see section 4.3.8 to set up the low level digital input	0	0-99	

Table 37: Low Level Variables

4.5.9 Volts Tolerance

Path: Status Screens / Setup (3) / Alrm/Evt (5) / Volts Tolerance (9)

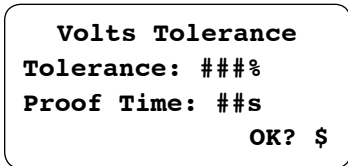

See Table 38 for a description of the Voltage variables.

Variable	Units	Description	Default Value	Range	Field Value
Tolerance	%	This tolerance is applied to the nameplate voltage. A value of 0 disables this alarm.	0	0-100	
Proof Time	Sec-onds	The proof timer prior to setting a voltage alarm.	3	0-99	

Table 38: Voltage Variables

4.6 EZ-Start

Path: Status Screens / Setup (3) / EZ-Start (6)

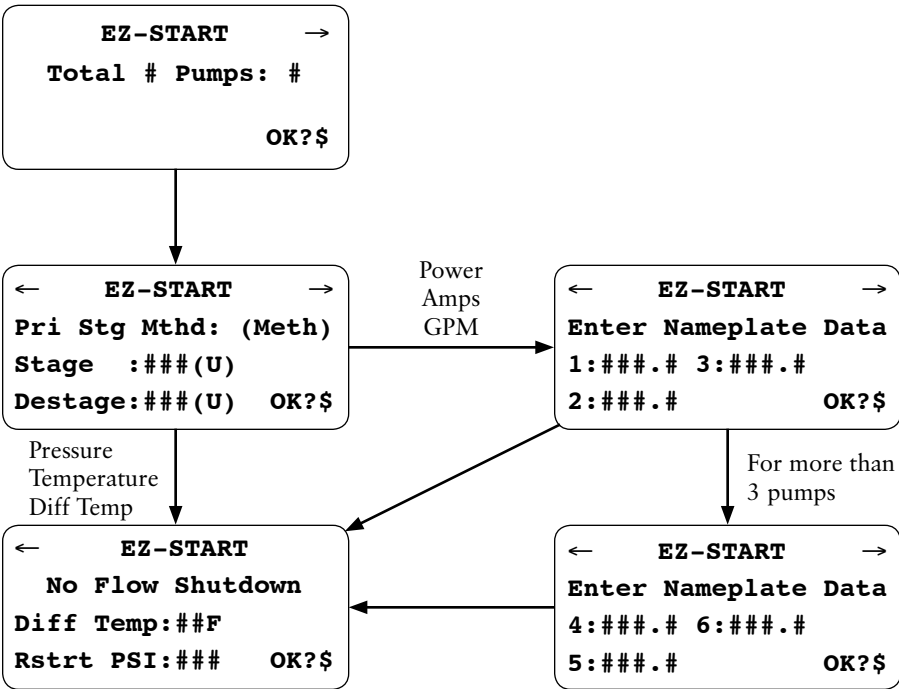

EZ-Start will prompt the user for the parameters required to start up the system quickly. Some of these values will already be correct due to the factory setup that is done for each Technologic® Constant Speed Pump Controller. Use PREV and NEXT to navigate through these screens while the cursor is on the OK field. Press NO and ENTER at the OK prompt to edit the values, or press YES and ENTER to accept and exit EZ-Start.

4.7 Log Menu

Path: Status Screens / Log (5)

```

Log Menu: # 0=Exit ↑
1=Alarm Log
2=Pump Log Menu
3=Data Log ↓
    
```

```

Log Menu: # 0=Exit ↑
4=Data Log Rate
5=Operation Menu
6=Totals ↓
    
```

```

Log Menu: # 0=Exit ↑
7=Reset Totals
8=Log Book ↓
    
```

Press UP/DOWN to view the entire menu.

4.7.1 Alarm Log

Path: Status Screens / Log (5) / Alarm Log (1)

```

MMDD HHMM (alarm)
MMDD HHMM (alarm)
MMDD HHMM (alarm)
MMDD HHMM (alarm)
    
```

Every alarm that occurs will be logged with a date and time stamp. The forty most recent alarms will be stored. The date is displayed in MMDD format and the time in 24 hour HHMM format. The most recent alarm is shown first. Press UP and DOWN to view more log events. Press CLEAR to exit.

4.7.2 Pump Log Menu

Path: Status Screens / Log (5) / Pump Log Menu (2)

```

Pump Log:# 0=Exit
1=Pump State
2=Pump Runtime
3=Reset Pmp Runtime
    
```

Press the numeric key corresponding to the desired sub-menu, and press ENTER.

4.7.2.1 Pump State Log

Path: Status Screens / Log (5) / Pump Log Menu (2) / Pump State (1)

```

Pump State
Pump # 1 MM/DD
(state) HH/MM
Scr# 1
    
```

Each time a pump’s state changes, the date and time are recorded along with the new pump state. The sixty most recent pump state changes will be stored. Possible states are ON, RDY, OFF, and FAIL. The date is displayed in MMDD format and the time in 24 hour HHMM format. Press UP/DOWN to view more log events. Press CLEAR to exit.

4.7.2.2 Pump Runtime Log

Path: Status Screens / Log (5) / Pump Log Menu (2) / Pump Runtime (2)

```

Pump Run Time Log
P1:### P2:### P3:###
P4:### P5:### P6:###
OK? $ (Y/N)
    
```

The pump runtimes may be used to automatically alternate the pump staging sequence so that the pump with the lowest runtime will be the lead pump. See section 4.3.2 for more information on alternation. The runtime is continuously recorded for each pump and is displayed in hours. To reset the pump runtimes see section 4.7.2.3.

4.7.2.3 Reset Pump Runtime

Path: Status Screens / Log (5) / Pump Log Menu (2) / Reset Pmp Runtime (3)

```

Reset Pump Runtime?
P1:$ P2:$ P3:$
P4:$ P5:$ P6:$
OK? $ (Y/N)
    
```

See Table 39 for a description of the variables.

Variable	Description
P1-P6	Enter a “Y” next to each pump for which the runtime will be reset. To view the pump runtimes, see section 4.7.2.2.

Table 39: Reset Pump Runtime

4.7.3 Data Log

Path: Status Screens / Log (5) / Data Log (3)

```

AI/RTD# (Type)
Max=##### MM/DD
Min=##### HH:MM
Avg=##### Scr# 1
    
```

The Data Log screen will show the minimum, maximum and average values for each analog input and RTD input channel. The sixty most recent data log intervals will be stored. The analog input or RTD channel along with the type of sensor set up for that channel will be displayed on the top line. Press NEXT

and PREV to scroll through the analog input and RTD channels. Press UP and DOWN to change the Scr # showing the next log event for that sensor. The date is displayed in MMDD format and the time in 24 hour HHMM format. See section 4.7.4 to change the data log rate. Press CLEAR to exit.

4.7.4 Data Log Rate

Path: Status Screens / Log (5) / Data Log Rate (4)

```

Data Log Rate:$$$$$

                OK? $ (Y/N)
    
```

See Table 40 for a description of the Data Log Rate variables.

Variable	Description	Default Value	Range	Field Value
Data Log Rate	One data point for the data log is taken at the end of each interval defined by the Data Log Rate	None	None, Minute, Hour, Day, Week, Month	

Table 40: Data Log Rate Variable

4.7.5 Operation Log Menu

Path: Status Screens / Log (5) / Operation Menu (5)

```

Op Log Menu:# 0=Exit
1=Op Mode Changes ↑
2=Power Cycles ↓
3=Events Log
    
```

```

Op Log Menu:# 0=Exit
4=Purge Log ↑
5=Exercise Log ↓
6=Operating Hours
    
```

Press UP/DOWN to view the entire menu.

4.7.5.1 Operation Mode Changes Log

Path: Status Screens / Log (5) / Operation Menu (5) / Op Mode Changes (1)

```

Operation Mode
                MM/DD
Start/Manual HH/MM
                Scr# 1
    
```

Every time the START/STOP key or the AUTO/MANUAL key is pressed, the event will be logged by showing the state of both variables immediately after the change. The sixty most recent operation mode changes will be stored. The date is displayed in

MMDD format and the time in 24 hour HHMM format. The most recent event will be shown first. Press UP/DOWN to change the Scr # showing the next log event. Press CLEAR to exit.

4.7.5.2 Power Cycles Log

Path: Status Screens / Log (5) / Operation Menu (5) / Power Cycles (2)

```

MMDD HHMM Power Up
MMDD HHMM Power Down
MMDD HHMM Power Up
MMDD HHMM Power Down
    
```

Each time the controller is powered up or down, the event will be logged. “Power Up” will be shown if powered up, and “Power Down” will be shown if powered down. The sixty most recent power cycles will be stored. The date is displayed in MMDD format and the time in 24 hour HHMM format. The most recent event will be shown first. Press UP/DOWN to view the next log event. Press CLEAR to exit.

4.7.5.3 Events Log

Path: Status Screens / Log (5) / Operation Menu (5) / Events Log (3)

```

MMDD HHMM Event
MMDD HHMM Event
MMDD HHMM Event
MMDD HHMM Event
    
```

Each time an event occurs, it will be logged. The forty most recent events will be stored. The date is displayed in MMDD format and the time in 24 hour HHMM format. The most recent event is shown first. Press UP/DOWN to view more log events. Press CLEAR to exit.

4.7.5.4 Purge Log

Path: Status Screens / Log (5) / Operation Menu (5) / Purge Log (4)

```

Purge MM/DD HH:MM
Log MM/DD HH:MM
                MM/DD HH:MM
                MM/DD HH:MM
    
```

Each time purging occurs, it will be logged. See section 4.3.11 to set up purging. This option will only be available for Tech 350 applications. The forty most recent purges will be stored. The date is displayed in MMDD format and the time in 24 hour HHMM format. The most recent event is shown first. Press UP/DOWN to view more log events. Press CLEAR to exit.

4.7.5.5 Exercise Log

Path: Status Screens / Log (5) / Operation Menu (5) / Exercise Log (5)

```

Pump #   MM/DD HH:MM
Pump #   MM/DD HH:MM
Pump #   MM/DD HH:MM
Pump #   MM/DD HH:MM
    
```

Each time a pump is exercised, the pump number along with a date and time stamp will be logged. The forty most recent exercises will be stored. The date is displayed in MMDD format and the time in 24 hour HHMM format. The most recent event is shown first. Press UP/DOWN to view more log events. Press CLEAR to exit.

4.7.5.6 Operating Hours

Path: Status Screens / Log (5) / Operation Menu (5) / Operating Hours (6)

```

Operating Since
MM/DD/YY
Total Hours=#####
Press Clear to Exit
    
```

The six digit date is displayed in the MM/DD/YYYY format. The total number of hours that the unit has been in operation is also displayed. See section 4.7.7 to reset the total hours. Press CLEAR to exit.

4.7.6 Totals

Path: Status Screens / Log (5) / Totals (6)

```

Total KW-Hrs=#####
Total Flow=#####
Total KBTUs=#####
OK? $ (Y/N)
    
```

When the system is started and in automatic operation, the totals will be updated continuously. The total pump energy is displayed in KW-Hrs. The total flow is displayed in gallons. The total thermal energy dissipated in a system is continuously updated and is displayed in thousands of BTUs. A flow meter is required to calculate Total flow and KBTUs. KBTUs are only practical for closed HVAC systems in which a differential temperature measured by the RTDs will reflect the heat dissipated in the system. See section 4.7.7 to reset these totals.

4.7.7 Reset Totals

Path: Status Screens / Log (5) / Reset Totals (7)

```

Reset Totals
Op Hrs? $   Power? $
BTUs? $
Flow? $     OK? $
    
```

See section 0 to view the totals that are logged. See Table 41 for a description of the Reset Totals variables.

Variable	Description
Operating Hrs	Select Y to reset the total operating hours
BTUs	Select Y to reset the total BTUs
Flow	Select Y to reset the total Flow
Power	Select Y to reset the total Power

Table 41: Reset Totals Variables

4.7.8 Log Book

Path: Status Screens / Log (5) / Log Book (8)

```

#### MM/DD HH:MM
#### MM/DD HH:MM
#### MM/DD HH:MM
#### MM/DD HH:MM
    
```

The Log Book records events on the CPU. These include power cycles, clearing the memory, changing the time, and software or hardware faults. The forty most recent CPU events will be stored. A four digit numeric code for these events will be displayed along with the date in MMDD format and the time in 24 hour HHMM format. The numeric codes are for factory use, and they may be requested by the factory for troubleshooting purposes. The most recent events are shown from top to bottom. Press UP/DOWN to view more log events. Press CLEAR to exit.

Section 5 — Maintenance

5.1 Battery

The system memory, including all user setup data, is buffered by a 3V lithium battery while the unit is off. When the controller begins to detect low voltage on the battery, it will display an alarm to give the user adequate time to replace it. If the battery is not replaced, the user setup data may be lost when the unit is powered down.

5.2 Signal Generator (analyzer) - recommended

The following signal generators are recommended: Beta calibrator Model 434 20mA signal analyzer, Atek calibrator Model 334 4-20mA loop analyzer or Druck USP III loop calibrator. The instruments may be purchased from a Local Process Control Distributor. If some other instrument is used it must float above ground, and preferably be battery powered.

5.3 Field Repair

Typical field repairs include replacing fuses, replacing input/output modules, and assuring connections are correct and secure. See Table 42 for a list of spare parts.

⚠ DANGER: Troubleshooting live control panels exposes personnel to hazardous voltages. Electrical troubleshooting must only be done by a qualified electrician. **FAILURE TO FOLLOW THESE INSTRUCTIONS WILL RESULT IN SERIOUS PERSONAL INJURY, DEATH, AND/OR PROPERTY DAMAGE.**

Description	ITT Part Number
Operator Interface Panel	S14368
Relay and power monitor rack	S14369
CT (40 Amp)	S14370
CT (150 Amp)	S14371
CT (400 Amp)	S14372
AI984	S14373
EX270	S13268
DO722	S12572
Lithium Battery	S12327
Power Supply (1 amp)	BP0140
Low Suction Pressure Switch NEMA 1 (10-100psi)	S76833
Low Suction Pressure Switch NEMA 4 (0-100psi)	BP0223

Description	ITT Part Number
Low Level Relay	176309
Low Level Plug-In Module Socket	211161
Probes for indoor use	176203
Probes for outdoor use	179524
DP Switch	S12221
Pressure Transducer (0-100PSI)	S13203
Pressure Transducer (0-300PSI)	S13204
RTD	S13205
Flow Switch (NEMA 1)	120611
Flow Switch (NEMA 4)	120610
Horn	S76699
Pilot Light (Red)	DE1793
Thermal Relief Valve	S51260

Table 42: Spare Parts

5.4 Program Updating

To update to a new version of software, the program must be uploaded through the RS232 port on the controller using a laptop. Consult the factory for any updates.

5.5 Info Screens

Path: Status Screens / Info (8)

← INFO →

Job#:QM1234 **Ver:**1.0
Volts:460 **App:**70E
Comms:None **3Φ:**\$

← INFO →

Suc Pr:### **CT:**40
Sys Pr:### **G:**####
Pumps: # # # **O:**####

← INFO →

HP1:###.# **HP4:**###.#
HP2:###.# **HP5:**###.#
HP3:###.# **HP6:**###.#

The Info screens contain all of the parameters that have been factory set. See Table 43 for a description of the variables.

Variable	Description	Range
Job #	Job #, this will be helpful for service calls	QM or QB 0000-9999
Ver	Software version number	1.0 – 9.99
Volts	Incoming Voltage, used as the nominal value for the voltage tolerance alarm	208/230/ 460/575
App	Application type (70E = open system, 350 = closed system)	70E/350
Comms	Serial communication protocol	BACnet, Modbus, JC N2, Lonworks
3Φ	“Y” should be selected for three phase voltage and “N” should be selected for single phase.	Y/N
Suc Pr	Suction Pressure	0-999
Sys Pr	System Pressure, used to set default alarm values for high suction pressure, low system pressure, high system pressure, and the restart PSI for no flow shutdown	0-999

Variable	Description	Range
# Pumps	Number of pumps that were entered by the factory (Total number, number of jockey pumps, number of standby pumps), see section 4.2.1.	1-6
CT	Size of the current transformer in amps, this must be correct for proper amp and power measurement.	40, 150, 400
G	Gain for CT calibration (printed on the label on the CT), this must be correct for proper amp and power measurement.	Hex values 0-F
O	Offset for CT calibration (printed on the label on the CT), this must be correct for proper amp and power measurement.	Hex values 0-F
HP1-6	Horsepower for each pump that was entered by the factory, see section 4.2.2.	0-999.9

Table 43: Info Screens Variables

Note: There are redundant setup screens for horsepower and number of pumps. The values entered here are used to set default values only. The actual parameters used for operation are shown in section 4.2 and may be different than the values shown here.

5.6 Troubleshooting

Problem	Solution
Service Mode LED (blank screen)	Set the node switches on the controller to 0 and 0 and cycle power. Set the node switches back to 1 and 1 and cycle power again.
Pump won't start	Check that the Start/Stop LED is on. Check that the pump status LEDs are blinking to indicate that they are ready. Press the HELP key from the status screens to check the alarm screen for any conditions that may prevent the pumps from running. If the RESET/ SILENCE LED is flashing, a manual reset of the system is required.
Pumps won't stage on/off	Check the Staging screen to see what the staging method is and what the next staging values are. See section 3.4.4. Check the timers screen to be sure that the pump minimum run timer is expired prior to destaging. See section 3.4.5.
No Flow Shutdown will not occur	Check the Timers screen to be sure that the NFSD minimum run time has expired. Only one pump must be running and the system pressure must be greater than the NFSD restart pressure in order for NFSD to occur. See section 4.5.6.
Inaccurate amps, voltage or power readings	Check that the calibration values printed on the label on the current transformer correspond to the values shown in the Info screens. See section 5.5.

Section A — Parameter List

Variable	Description	Section	Default Value	Field Value
AI #1 Type	Type of sensor connected to this channel	4.1	Suc Press	
AI#1 Span	Sensor value that corresponds to a 20mA signal	4.1	100	
AI#1 Zero	Sensor value that corresponds to a 4mA signal	4.1	0	
AI #2 Type	Type of sensor connected to this channel	4.1	Sys Press	
AI #2 Span	Sensor value that corresponds to a 20mA signal	4.1	300	
AI #2 Zero	Sensor value that corresponds to a 4mA signal	4.1	0	
AI #3 Type	Type of sensor connected to this channel	4.1	None	
AI #3 Span	Sensor value that corresponds to a 20mA signal	4.1	0	
AI #3 Zero	Sensor value that corresponds to a 4mA signal	4.1	0	
AI #4 Type	Type of sensor connected to this channel	4.1	None	
AI #4 Span	Sensor value that corresponds to a 20mA signal	4.1	0	
AI #4 Zero	Sensor value that corresponds to a 4mA signal	4.1	0	
RTD #1 Type	Type of RTD connected to this channel	4.1	Suc Temp	
RTD #2 Type	Type of RTD connected to this channel	4.1	Sys Temp	
Total # Pumps	The total number of pumps in the system.	4.2.1	Factory Set	
# Jockey Pumps	Jockey pumps will always be first in the staging sequence. Alternation will not change this designation. Jockey Pumps will be assigned to the lowest pump numbers starting with Pump # 1.	4.2.1	0	
# Standby Pumps	A standby pump will only operate if a duty pump fails. The last pumps in the staging sequence will be designated as the standby pumps.	4.2.1	0	
HP	Enter the horsepower from the nameplate of the motor. These values are required for power staging.	4.2.2	Actual	
Amps	Enter the full load amps from the motor nameplate. These values are required for amps staging.	4.2.2	0	
GPM	Enter the maximum GPM from the pump nameplate. These values are required for flow staging.	4.2.2	0	
Pri Stg Mthd	Primary staging method. Power, Amps, and flow staging require nameplate data to be set up. See section 4.2.2.	4.3.1.1	Power	
Stg (primary)	The value at which pumps will stage on. The units depend on the staging type. This is the stage 1-2 value and will be used for each staging occurrence unless Dynamic Stg is set to “Y”.	4.3.1.1	80	
Dstg (primary)	The value at which pumps will stage off. The units depend on the staging type. This is the destage 2-1 value and will be used for each destaging occurrence unless Dynamic Stg is set to “Y”.	4.3.1.1	72	
PT (primary)	The proof timer, in seconds, that will elapse before staging pumps on/off.	4.3.1.1	5	
Dynamic Stg (primary)	Select “Y” for Dynamic Stg to choose different staging and destaging values for each staging occurrence. A separate screen will be displayed to allow for these inputs.	4.3.1.1	N	
Sec Stg Mthd	Secondary staging method. This will be used if the sensor for the primary method fails. Power, Amps, and flow staging require nameplate data to be set up. See section 4.2.2.	4.3.1.2	Pressure	
Stg (secondary)	The value at which pumps will stage on. The units depend on the staging type. This is the stage 1-2 value and will be used for each staging occurrence unless Dynamic Stg is set to “Y”.	4.3.1.2	System Pressure – 10	
Dstg (secondary)	The value at which pumps will stage off. The units depend on the staging type. This is the destage 2-1 value and will be used for each destaging occurrence unless Dynamic Stg is set to “Y”.	4.3.1.2	System Pressure – 3	
PT (secondary)	The proof timer, in seconds, that will elapse before staging pumps on/off.	4.3.1.2	5	

Variable	Description	Section	Default Value	Field Value
Dynamic Stg (secondary)	Select "Y" for Dynamic Stg to choose different staging and destaging values for each staging occurrence. A separate screen will be displayed to allow for these inputs.	4.3.1.2	"N"	
Force Dstg Tmr	Maximum time, in minutes, a lag pump will run prior to destaging automatically, a value of 0 disables forced destaging. See section 3.4.5 for display of timer status.	4.3.1.3	60	
Min Run Timer	Minimum time, in minutes, a lag pump must run prior to destaging, a value of 0 effectively disables the minimum run timer. See section 3.4.5 for display of timer status.	4.3.1.3	5	
Alt Method	Automatic Alternation Method None: disables automatic alternation Timed: alternates based on the "Period" Daily: alternates daily based on the "Time" Weekly: alternates weekly based on the "Time" and the "Day" Monthly: alternates monthly based on the "Time" and the "Day"	4.3.2	None	
Basis (Alternation)	Seq: the next pump in the sequence will become the lead pump after alternation Pmp Tm: the pump with the lowest run time will become the lead pump after alternation	4.3.2	Seq	
Dur (Alternation)	Amount of time, in seconds, that the running pumps will remain on during alternation	4.3.2	10	
Time (Alternation)	Time, in 24hr format, at which the pumps will be alternated for daily, weekly, or monthly alternation	4.3.2	0:00	
Day (Alternation)	Day of the week (1=Monday...7=Sunday) or month (day of month) on which the pumps will be alternated	4.3.2	1	
Period (Alternation)	Time, in hours, between pump alternations when using "Timed" alternation	4.3.2	168	
Period (exercise)	Time, in hours, between automatic exercising of the pumps, a value of 0 disables pump exercising	4.3.3	0	
Duration (exercise)	Time, in seconds, pumps will be exercised, all pumps which have not run in the last period will be exercised simultaneously	4.3.3	0	
Start/stop method	Keypad: Use the keypad to start and stop the system Remote: Use "Start/Stop Sw" tied to DI #7 Serial: Use "System Start/Stop" shown in appendix C Scheduled: Use scheduling to start and stop the system, see section 4.3.5	4.3.4	Keypad	
ON @ (Scheduling)	Time at which the system will automatically start. Set the hour to 0 to prevent the system from starting on this day.	4.3.5	0:00 am	
Off @ (Scheduling)	Time at which the system will automatically stop. Set the hour to 0 to prevent the system from stopping on this day.	4.3.5	0:00 am	
Relay Output Functionality	Relay output functionality for relays 1-8	4.3.8	1M-6M are factory set	
Enable BACnet	This must be set to "Y" to utilize RS-485 communications. It should only be set to "N" to upload software upgrades.	4.3.10.1	Y	
Baud	The baud rate is user adjustable	4.3.10.1	9600	
MAC Address	The MAC address or node number should be supplied by the BMS.	4.3.10.1	10	
Inst	Unique instance numbers should be assigned for every device on a BACnet network.	4.3.10.1	100	
AI Ovrld	Select "Y" to override analog inputs through the communications port. See section 4.3.10.5.	4.3.10.1	N	
Enable Metasys N2	This must be set to "Y" to utilize RS-485 communications. It should only be set to "N" to upload software upgrades.	4.3.10.2	Y	

Variable	Description	Section	Default Value	Field Value
Node	The node number should be supplied by the BMS.	4.3.10.2	10	
AI Ovrld	Select “Y” to override analog inputs through the communications port. See section 4.3.10.5.	4.3.10.2	N	
Enable Modbus	This must be set to “Y” to utilize RS-485 communications. It should only be set to “N” to upload software upgrades.	4.3.10.3	Y	
Node	The node number should be supplied by the BMS.	4.3.10.3	10	
AI Ovrld	Select “Y” to override analog inputs through the communications port. See section 4.3.10.5.	4.3.10.3	N	
Enable Lonworks	This must be set to “Y” to enable Lonworks communications.	4.3.10.4	Y	
AI Ovrld	Select “Y” to override analog inputs through the communications port. See section 4.3.10.5.	4.3.10.4	N	
Purge Time	Time, in minutes, that the pumps will run immediately after starting the system in automatic mode, a value of 0 disables purging.	4.3.11	10	
Number of Pumps (Purge)	Number of pumps that will turn on when purging is active.	4.3.11	1	
App Type	The application type is required if staging will be based on temperature.	4.3.11	Cool	
DP Switch Pr Tm	Proof timer, in seconds, prior to setting a pump fail alarm after receiving a continuous high signal from a DP switch	4.5.1	10	
Low Sys Press	The pressure, in PSI, below which an alarm or event will be set	4.5.2	½ System Pressure	
Low Sys Pr Tm	The proof timer, in seconds, prior to setting an alarm or event. A value of 0 disables this alarm or event.	4.5.2	0	
Alarm (Low Sys Pr)	Set this value to “Y” to consider low system pressure an alarm, or set it to “N” to consider it an event.	4.5.2	N	
Stop Pumps (Low Sys Press)	Set this value to “Y” to stop all pumps in the event of a low system pressure alarm or event. Set it to “N” to continue operation normally during this alarm or event.	4.5.2	N	
High Sys Press	The pressure, in PSI, above which an alarm will be set	4.5.3	1.5 x System Pressure	
High Sys Pr Tm	The proof timer, in seconds, prior to setting an alarm. A value of 0 disables this alarm.	4.5.3	20	
Low Suct Press	The pressure, in PSI, below which an alarm or event will be set for the analog input method	4.5.4	5	
Pr Tm (Low Suct Press)	The proof timer, in seconds, prior to setting an alarm or event. A value of 0 will disable this alarm. Used for analog input and pressure switch methods.	4.5.4	20	
Auto Reset (Low Suct Press)	Select “Y” to allow this alarm or event to be automatically reset. The analog input method resets using the “Reset Press”. The pressure switch method resets on a low signal on the low suction pressure switch digital input.	4.5.4	Y	
Reset Press (Low Suct Press)	The pressure, in PSI, at which the controller will automatically reset when the suction pressure rises above it. Used for the analog input method only.	4.5.4	10	
Alarm (Low Suct Press)	Set this value to “Y” to consider low suction pressure an alarm, or set it to “N” to consider it an event. Used for analog input and pressure switch methods.	4.5.4	N	
High Suc Press	The pressure, in PSI, above which an alarm or event will be set	4.5.5	System Pressure	
High Suc Pr Tm	The proof timer, in seconds, prior to setting an alarm or event. A value of 0 disables this alarm.	4.5.5	0	

Variable	Description	Section	Default Value	Field Value
Reset Press (High Suc Press)	The controller will automatically reset when the suction pressure, in PSI, falls below the “Reset Press”	4.5.5	0.9 x System Pressure	
Alarm (High Suc Press)	Set this value to “Y” to consider high suction pressure an alarm, or set it to “N” to consider it an event.	4.5.5	N	
Diff Temp (NFSD)	Differential temperature limit, in °F, between the suction and system temperature sensors, prior to setting a no flow shutdown alarm or event.	4.5.6	5	
NFSD Pr Tm	Proof timer, in seconds, prior to setting a NFSD alarm or event. Used for differential temperature and flow switch methods.	4.5.6	10	
Restrt PSI (NFSD)	Pressure, in PSI, at which the controller will automatically reset from a NFSD when the system pressure falls below it. Used for differential temperature and flow switch methods.	4.5.6	System Pressure – 10	
Min Run Tm (NFSD)	Amount of time, in minutes, for which the NFSD condition will be ignored after restarting the system from a previous NFSD. Used for differential temperature and flow switch methods. See section 3.4.5 for display of timer status.	4.5.6	10	
Alarm (NFSD)	Set this value to “Y” to consider NFSD an alarm, or set it to “N” to consider it an event. Used for differential temperature and flow switch methods.	4.5.6	N	
High Temp	The system temperature, in °F, above which a High Temperature alarm or event will be set.	4.5.7	125	
High Temp Pr Tm	The proof timer, in seconds, prior to setting a high temperature alarm. A value of 0 disables this alarm.	4.5.7	20	
High Temp Reset	The system temperature, in °F, below which the high system temperature alarm will be automatically reset	4.5.7	100	
Time (Low Level)	The proof time, in seconds, prior to setting a low level alarm, see section 4.3.8 to set up the low level digital input.	4.5.8	0	

Section B — BACnet Protocol Implementation Conformance Statement for BACnet MS/TP

Date:	1/8/07
Vendor Name:	Bell & Gossett
Product Name:	Technologic Constant Speed Pump Controller
Product Model Number:	N/A
Applications Software Version:	1.2 or above
Firmware Revision:	N/A
BACnet Protocol Revision:	2.0

Product Description:

The Technologic® Constant Speed Pump Controller is a constant speed pump controller. It operates either as a stand-alone controller or as part of a building-wide integrated system. The BACnet communication interface will provide communication between the Technologic® Constant Speed Pump Controller and the BACnet system residing on EIA-485 media.

BACnet Standardized Device Profile (Annex L): BACnet Application Specific Controller

BACnet Interoperability Building Blocks Supported (Annex K): DS-RP-B, DS-WP-B, DM-TS-B, DM-DDB-B

Segmentation Capability: Not Supported

Standard Object Types Supported:

Analog input

Dynamically creatable:	No	
Dynamically deletable:	No	
Optional properties supported:	None	
Writable properties:	Present Value Out Of Service	Conditionally writable
Proprietary properties:	None	
Property range restrictions:	None	

Analog output

Dynamically creatable:	No	
Dynamically deletable:	No	
Optional properties supported:	None	
Writable properties:	Present Value	
Proprietary properties:	None	
Property range restrictions:	None	

Analog value

Dynamically creatable:	No	
Dynamically deletable:	No	
Optional properties supported:	None	
Writable properties:	Present Value Out Of Service	Conditionally writable
Proprietary properties:	None Out Of Service	
Property range restrictions:	None	

Binary input

Dynamically creatable:	No	
Dynamically deletable:	No	
Optional properties supported:	None	
Writable properties:	Present Value Out Of Service	Conditionally writable
Proprietary properties:	None	
Property range restrictions:	None	

Binary output

Dynamically creatable:	No	
Dynamically deletable:	No	
Optional properties supported:	None	
Writable properties:	Present Value	
Proprietary properties:	None	
Property range restrictions:	None	

Binary value

Dynamically creatable:	No	
Dynamically deletable:	No	
Optional properties supported:	None	
Writable properties:	Present Value Out Of Service	Conditionally writable
Proprietary properties:	None	
Property range restrictions:	None	

Device

Dynamically creatable:	No	
Dynamically deletable:	No	
Optional properties supported:	Local_Date Local_Time Max_Master Max_Info_Frames	
Writable properties:	Max_Master	
Proprietary properties:	None	
Property range restrictions:	None	

Data Link Layer Options:

- MS/TP master (Clause 9), baud rate(s): 9600, 19200, 38400
- MS/TP slave (Clause 9), baud rate(s): 9600, 19200, 38400

Device Address Binding: N/A

Character Sets Supported: ANSI X3.4

Section C — Serial Communications Points

Description	Read	Write	Range/Value	Modbus Address	Bacnet Address	Lonworks NV Index	N2 Address
System Start/Stop Status	X		1=Start, 0=Stop	10001	BI 1	0	BI 1
System Auto/Manual Status	X		1=Auto, 0=Manual	10002	BI 2	1	BI 2
General Alarm	X		1=Fail, 0=OK	10003	BI 3	2	BI 3
Reset Required	X		1=Reset is Required, 0=OK	10004	BI 4	3	BI 4
AI 1 Fail	X		1=Fail, 0=OK	10005	BI 5	4	BI 5
AI 2 Fail	X		1=Fail, 0=OK	10006	BI 6	5	BI 6
AI 3 Fail	X		1=Fail, 0=OK	10007	BI 7	6	BI 7
AI 4 Fail	X		1=Fail, 0=OK	10008	BI 8	7	BI 8
RTD 1 Fail	X		1=Fail, 0=OK	10009	BI 9	8	BI 9
RTD 2 Fail	X		1=Fail, 0=OK	10010	BI 10	9	BI 10
Battery Fail	X		1=Fail, 0=OK	10011	BI 11	10	BI 11
Low Suction Pr (AI)	X		1=Fail, 0=OK	10012	BI 12	11	BI 12
Low Suction Pr (Switch)	X		1=Fail, 0=OK	10013	BI 13	12	BI 13
High Suction Pr	X		1=Fail, 0=OK	10014	BI 14	13	BI 14
Low System Pr	X		1=Fail, 0=OK	10015	BI 15	14	BI 15
High System Pr	X		1=Fail, 0=OK	10016	BI 16	15	BI 16
NFSD (Diff. Temp)	X		1=Fail, 0=OK	10017	BI 17	16	BI 17
NFSD (Flow Switch)	X		1=Fail, 0=OK	10018	BI 18	17	BI 18
Low Level	X		1=Fail, 0=OK	10019	BI 19	18	BI 19
High System Temperature	X		1=Fail, 0=OK	10020	BI 20	19	BI 20
Pump1 DP Fail	X		1=Fail, 0=OK	10021	BI 21	20	BI 21
Pump2 DP Fail	X		1=Fail, 0=OK	10022	BI 22	21	BI 22
Pump3 DP Fail	X		1=Fail, 0=OK	10023	BI 23	22	BI 23
Pump4 DP Fail	X		1=Fail, 0=OK	10024	BI 24	23	BI 24
Pump5 DP Fail	X		1=Fail, 0=OK	10025	BI 25	24	BI 25
Pump6 DP Fail	X		1=Fail, 0=OK	10026	BI 26	25	BI 26
Pump1 OL Fail	X		1=Fail, 0=OK	10027	BI 27	26	BI 27
Pump2 OL Fail	X		1=Fail, 0=OK	10028	BI 28	27	BI 28
Pump3 OL Fail	X		1=Fail, 0=OK	10029	BI 29	28	BI 29
Pump4 OL Fail	X		1=Fail, 0=OK	10030	BI 30	29	BI 30
Pump5 OL Fail	X		1=Fail, 0=OK	10031	BI 31	30	BI 31
Pump6 OL Fail	X		1=Fail, 0=OK	10032	BI 32	31	BI 32
CAN fail	X		1=Fail, 0=OK	10033	BI 33	32	BI 33
Voltage Tolerance Fail	X		1=Fail, 0=OK	10034	BI 34	33	BI 34
Voltage Fail	X		1=Fail, 0=OK	10035	BI 35	34	BI 35
System Start/Stop		X	1=Start, 0=Stop	00001	BO 1	60	BO 1
System Reset		X	Positive Edge = Reset/Silence	00002	BO 2	61	BO 2
Pump Alternation		X	Positive Edge = Alternate	00003	BO 3	62	BO 3
Pump1 State	X		0=Disabled, 1=Run, 2=Ready, 3=Failed	30001	AI 1	44	ADI 1

Serial Communications Points

Description	Read	Write	Range/Value	Modbus Address	Bacnet Address	Lonworks NV Index	N2 Address
Pump2 State	X		0=Disabled, 1=Run, 2=Ready, 3=Failed	30002	AI 2	45	ADI 2
Pump3 State	X		0=Disabled, 1=Run, 2=Ready, 3=Failed	30003	AI 3	46	ADI 3
Pump4 State	X		0=Disabled, 1=Run, 2=Ready, 3=Failed	30004	AI 4	47	ADI 4
Pump5 State	X		0=Disabled, 1=Run, 2=Ready, 3=Failed	30005	AI 5	48	ADI 5
Pump6 State	X		0=Disabled, 1=Run, 2=Ready, 3=Failed	30006	AI 6	49	ADI 6
Suction/Return Pressure	X	X*	0-Span	30007/ 40001	AI 7/AO 1	50/63	ADI 7
System/Supply Pressure	X	X*	0-Span	30008/ 40002	AI 8/AO 2	51/64	ADI 8
Flow	X	X*	0-Span	30009/ 40003	AI 9/AO 3	52/65	ADI 9
Temperature (4-20mA)	X	X*	0-Span	30010/ 4004	AI 10/AO 4	53/66	ADI 10
Pressure	X	X*	0-Span	30011/ 4005	AI 11/AO 5	54/67	ADI 11
Differential Temperature	X	X*	0-Span	30012/ 4006	AI 12/AO 6	55/68	ADI 12
Suction/Return Temp (RTD)	X		Actual °F	30013	AI 13	56	ADI 13
System/Supply Temp (RTD)	X		Actual °F	30014	AI 14	57	ADI 14
Amps	X		Actual Amps	30015	AI 15	58	ADI 15
Horsepower	X		Actual Horsepower	30016	AI 16	59	ADI 16

* “AI Ovrđ” must be set to “Y” for the corresponding sensor type in the communications setup screen in order to be writable. See section 4.3.10.5 for more information on analog input override.

Section D — Procedure for Field Balancing 70E/70M PRVs

The pressure reducing valves are factory set to the discharge pressure on the unit nameplate. If adjustment is required, check the following:

1. Does the desired system pressure correspond to the pressure indicated on the unit nameplate?
2. Is the suction pressure equal to or higher than the pressure indicated on the nameplate?
3. Is the demand (GPM) within the capacity indicated on the nameplate?
4. Have the PRV's been properly vented?

Any deviation from the above conditions will prevent the unit from operating at the factory settings.

 **WARNING: Excessive Pressure and Temperature Hazard** Do not operate pump(s) at or near zero flow (closed discharge valve). Explosion could result. **FAILURE TO FOLLOW THESE INSTRUCTIONS COULD RESULT IN SERIOUS PERSONAL INJURY, DEATH, AND/OR PROPERTY DAMAGE.**

To adjust the PRV, place the pump in manual operation. See section 3.3.1. With the pump running,

slowly close the main gate valve downstream of the discharge header, allowing a trickle of water to flow through it. Read the system pressure on the display. It should read 3 or 4 psi higher than the desired system pressure. If not, remove the protective cap on the pilot control valve and loosen the jam nut on the adjusting stem of the PRV. Slowly turn the stem clockwise to increase the delivery pressure and counter clockwise to decrease pressure. (Note that a pilot valve furnished for a 20 to 300 psi range will change the main valve setting approximately 28 psi for each full turn of the adjusting screw.) Set the screw so the system display reads 3 to 4 psi higher than the desired system pressure.

Open the gate valve fully. If feasible, draw between 50 to 80% of the designed pump capacity to recheck the valve setting. The display should now read the desired system pressure. Tighten jam nut and replace cap.

Repeat the above procedure for all pump and valve combinations as required.

The CV Flow Control Valve (opening speed control) may require field adjustment if pressure hunting occurs. Normal setting of the valve is from 4 to 7 turns open. Never open more than 8 turns.

Section E — Electrical Wiring and Control Settings – Final Check List

- ___ 1. Does the feeder line voltage correspond to the unit voltage? Check the unit nameplate.

 **WARNING:** Electrical shock hazard. Inspect all electrical connections prior to powering the unit. Wiring connections must be made by a qualified electrician in accordance with all applicable codes, ordinances, and good practices. **FAILURE TO FOLLOW THESE INSTRUCTIONS COULD RESULT IN SERIOUS PERSONAL INJURY, DEATH, AND/OR PROPERTY DAMAGE.**

- ___ 2. Are the feeder wires correctly sized for the load?
- ___ 3. Are the fuses sized correctly? They should be sized for approximately 150% of FLA and should not exceed 175%.
- ___ 4. Is the unit properly grounded?

 **WARNING:** Conduit grounds are not adequate. A separate ground wire must be attached to the ground lug provided in the enclosure to avoid potential safety hazards. **FAILURE TO FOLLOW THESE INSTRUCTIONS COULD RESULT IN SERIOUS PERSONAL INJURY, DEATH, AND/OR PROPERTY DAMAGE.**

- ___ 5. Have all the power terminals in the control panel been checked for tightness? This is imperative since stranded wires tend to “flow” and become loose after initial installation.

 **DANGER:** High voltage AC power can kill. Disconnect and lock out power prior to servicing unit. **FAILURE TO FOLLOW THESE INSTRUCTIONS WILL RESULT IN SERIOUS PERSONAL INJURY, DEATH, AND/OR PROPERTY DAMAGE.**

- ___ 6. Are all analog and digital inputs or outputs connected per the wiring diagram?

Section F — System Piping and Unit Installation - Final Check List

- ___ 1. Is the unit base properly leveled, grouted and secured?
- ___ 2. Are all lubrication points properly lubricated?
- ___ 3. Is the outlet side of the high temperature regulating valve connected to the drain with tubing or pipe size 3/8" or greater?
- ___ 4. Are the shut-off valves to the transmitters open?
- ___ 5. Are the shut-off valves on the pump suction and discharge open?
- ___ 6. Is the bypass valve, if used, closed? This valve may be left open if a check valve is installed in series with it.
- ___ 7. Are the stop cocks for the check feature on the PRV open? They must never be completely closed during normal operation. Throttle cock if check slamming is noted.
- ___ 8. Is the piping properly supported so as to prevent strains on the unit?
- ___ 9. Is the system, including the pumps and PRV's purged of debris and air?
- ___ 10. Are the bleed valves at the high temperature valve header open?
- ___ 11. Are the pump and motor shafts properly aligned?
- ___ 12. Is the pump rotation correct?

 **CAUTION:** Seal damage may occur. Do not run pumps dry. Fill and vent the pump volute prior to operation. **FAILURE TO FOLLOW THESE INSTRUCTIONS COULD RESULT IN PROPERLY DAMAGE AND/OR MODERATE PERSONAL INJURY.**

Section G — Quick Startup Checklist

Electrical Safety:

 **WARNING: Electrical Shock Hazard** Electrical connections to be made by a qualified electrician in accordance with all applicable codes, ordinances and good practices. **FAILURE TO FOLLOW THESE INSTRUCTIONS COULD RESULT IN SERIOUS PERSONAL INJURY, DEATH, AND/OR PROPERTY DAMAGE.**

 **WARNING: Electrical Overload Hazard** Three-phase motors must have properly sized heaters to provide overload and under voltage protection. Single-phase motors have built-in overload protectors. **FAILURE TO FOLLOW THESE INSTRUCTIONS COULD RESULT IN SERIOUS PERSONAL INJURY, DEATH, AND/OR PROPERTY DAMAGE.**

Thermal Safety:

 **WARNING: Extreme Temperature Hazard** If pump, motor or piping are operating at extremely high or low temperatures, guarding or insulation is required. **FAILURE TO FOLLOW THESE INSTRUCTIONS COULD RESULT IN SERIOUS PERSONAL INJURY, DEATH, AND/OR PROPERTY DAMAGE.**

Mechanical Safety:

 **WARNING: Unexpected Startup Hazard** Disconnect and lockout power before servicing. **FAILURE TO FOLLOW THESE INSTRUCTIONS COULD RESULT IN SERIOUS PERSONAL INJURY, DEATH, AND/OR PROPERTY DAMAGE.**

 **WARNING: Excessive Pressure and Temperature Hazard** Do not operate pump(s) at or near zero flow (closed discharge valve). Explosion could result. **FAILURE TO FOLLOW THESE INSTRUCTIONS COULD RESULT IN SERIOUS PERSONAL INJURY, DEATH, AND/OR PROPERTY DAMAGE.**

 **WARNING: Rotating Components Hazard** Do not operate the pump without all guards in place. **FAILURE TO FOLLOW THESE INSTRUCTIONS COULD RESULT IN SERIOUS PERSONAL INJURY, DEATH, AND/OR PROPERTY DAMAGE.**

 **WARNING: Excessive System Pressure Hazard** The maximum working pressure of the pump is listed on the nameplate Do not exceed this pressure. **FAILURE TO FOLLOW THESE INSTRUCTIONS COULD RESULT IN SERIOUS PERSONAL INJURY, DEATH, AND/OR PROPERTY DAMAGE.**

 **WARNING: Excessive Pressure Hazard Volumetric Expansion** The heating of water and other fluids causes volumetric expansion. The associated forces may cause failure of system components and release of high temperature fluids. This will be prevented by installing properly sized and located compression tanks and pressure relief valves. **FAILURE TO FOLLOW THESE INSTRUCTIONS COULD RESULT IN SERIOUS PERSONAL INJURY, DEATH, AND/OR PROPERTY DAMAGE.**

Section G — Quick Startup Checklist *(Continued)*

- Read these instructions completely before beginning.
- Confirm job site voltage. Do not apply power or close the disconnect until the following items are completed.
- Check all power wiring connections and secure as required.
- Confirm with the owner/installing contractor if there will be any building automation or remote connections required.
- Inspect and/or install any customer remote terminations required.
- Make note of the design data supplied on the B&G data label (inside of the control panel door)
- Use a volt meter to measure phase to phase voltage on the entering power terminals at the disconnect.
- Compare available voltage to the nameplate data.
- Field install the supply water temperature sensor (suction RTD)**
- Locate the sensor and connection wiring coiled in the panel (may have been coiled outside of the panel by the factory). Uncoil and feed the sensor through the back of the panel through a hole.
- Locate the sensor on the suction water supply pipe as far from the header as practical.
- Tape to the piping in such a manner as to protect the sensor and wiring from damage.
- Insulate the sensor with foam or fiberglass to prevent sensing ambient temperature.
- Bladder storage tank**
- Precharge the bladder storage tank before connecting to the system. The air precharged should be 5 to 10 psi less than the system operating pressure.
- If the storage tank has already been installed and not precharged, disconnect system piping from the tank and equalize to atmospheric pressure, if an isolation valve and drain are provided, use them.
- Apply air pressure to bladder through the air charging valve and pressurize to field conditions (equal to the NFSD restart pressure or 5 to 10 psi below operating pressure)
- Reconnect to the system piping
- Check for available suction water**
- Open all supply and discharge valves.
- Close bypass valve if installed in the piping by others.
- Inspect the capillary tybing from the pump discharge to the suction header.
- Open petcocks feeding the tubing.
- Ensure that the plastic tubing is not touching any metal surface. Protect tubing with insulation to prevent abrasion where it may be touching metal.
- Use the pump vent plugs and or the vent cocks on the main prv to prove available water for suction. Open a faucet to create a demand for water on the system pressure piping.
- Start the package**
- Close the disconnect to apply power to the package.
- If the unit starts, press the stop button to stop the unit.
- Prove pump rotation**
- Confirm that the Auto/Manual LED is off to indicate manual operation mode. If it is not, press the Auto/Manual key.
- Enable one pump (LED blinking) and disable all others (LED off) by pressing the corresponding Pump Enable keys.
- Press the Start/Stop key to start the pump and then quickly press the Pump Enable key to stop it.
- Observe the spinning shaft for rotation.
- Repeat for each pump
- If all pumps run backwards, reverse two leads of the incoming power.
- If only one or less than all pumps run backwards, reverse two leads on the pump motors that are incorrect.
- Set the system operating pressure**
- Open a faucet or some other demand for water from the discharge of the package. This can be anywhere in the building being served by the package.
- In Manual, run one pump.
- Adjust the PRV to the desired discharge pressure for the building being served.
- Repeat for each pump in the package, running only one pump at a time.
- All PRVs should be adjusted to the same pressure as seen on the display.
- Set system specific parameters**
- Press the Setup (3) key to enter the setup menu.
- Press 6 and Enter to get to EZ-Start.
- Use the arrows to navigate to the next screen, or press No (4) and Enter to edit the values. When EZ-Start is complete (the right arrow is not blinking), Press Yes (1) and Enter to exit EZ-Start.
- Testing the package**
- Exit the Setup Menu.
- Stop the package
- Press the Auto/Manual key to put the system into Auto operation, and then press Start.
- Observe the pressures and temperatures for normal operation.
- Press the alternation key, and then select Yes(1) and press Enter at the prompt, and observe each pump's operation.
- Close the running water faucet. It should be assumed that no demand for water is required. (No Flow)
- Wait for the no flow shut down sequence to engage. All minimum run timers must elapse for this to occur.
- Demand water from the system again and observe the restart of the package.
- No problems? You are done!**

Section H — Drawings

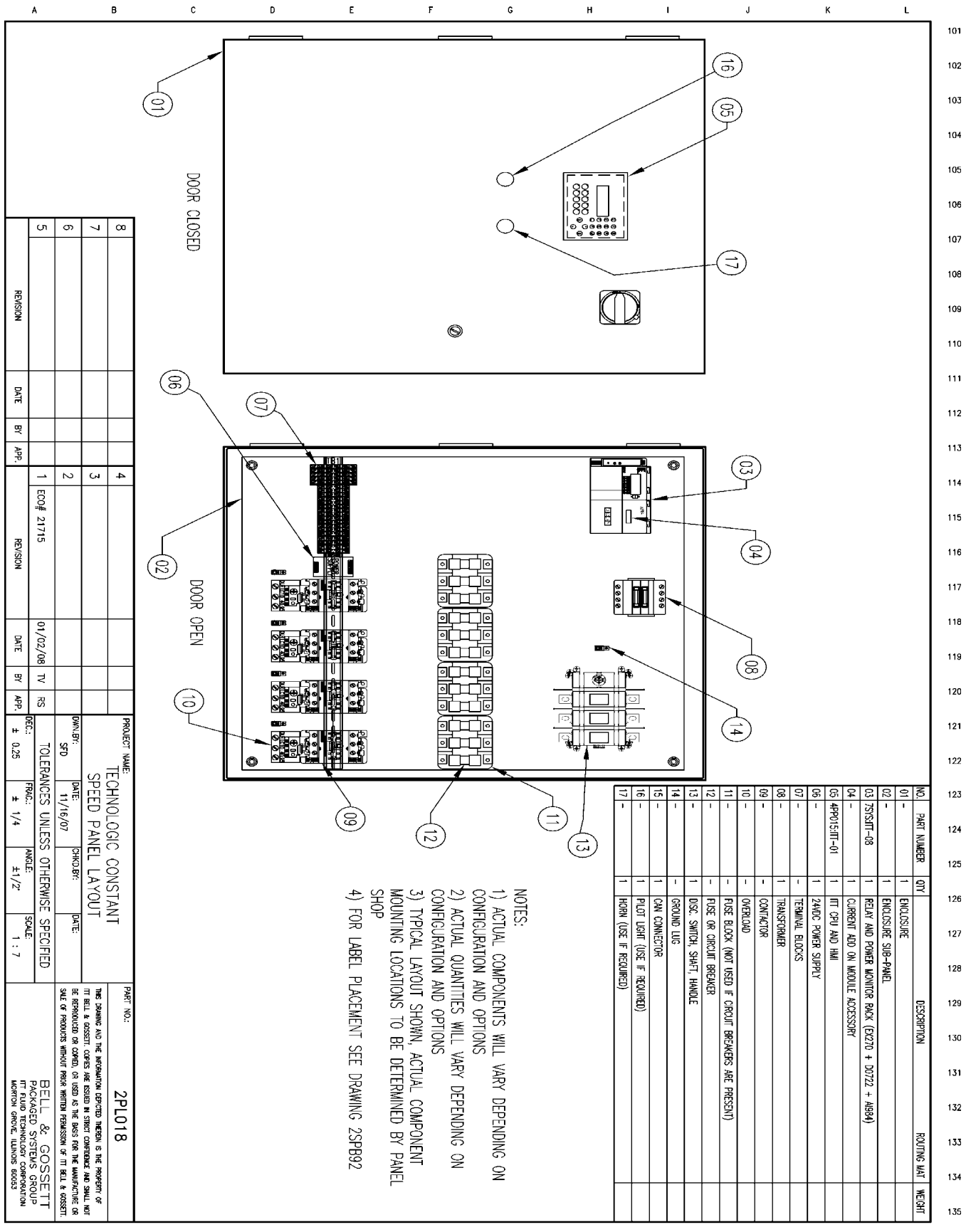

Drawing 1: Technologic Constant Speed Pump Controller

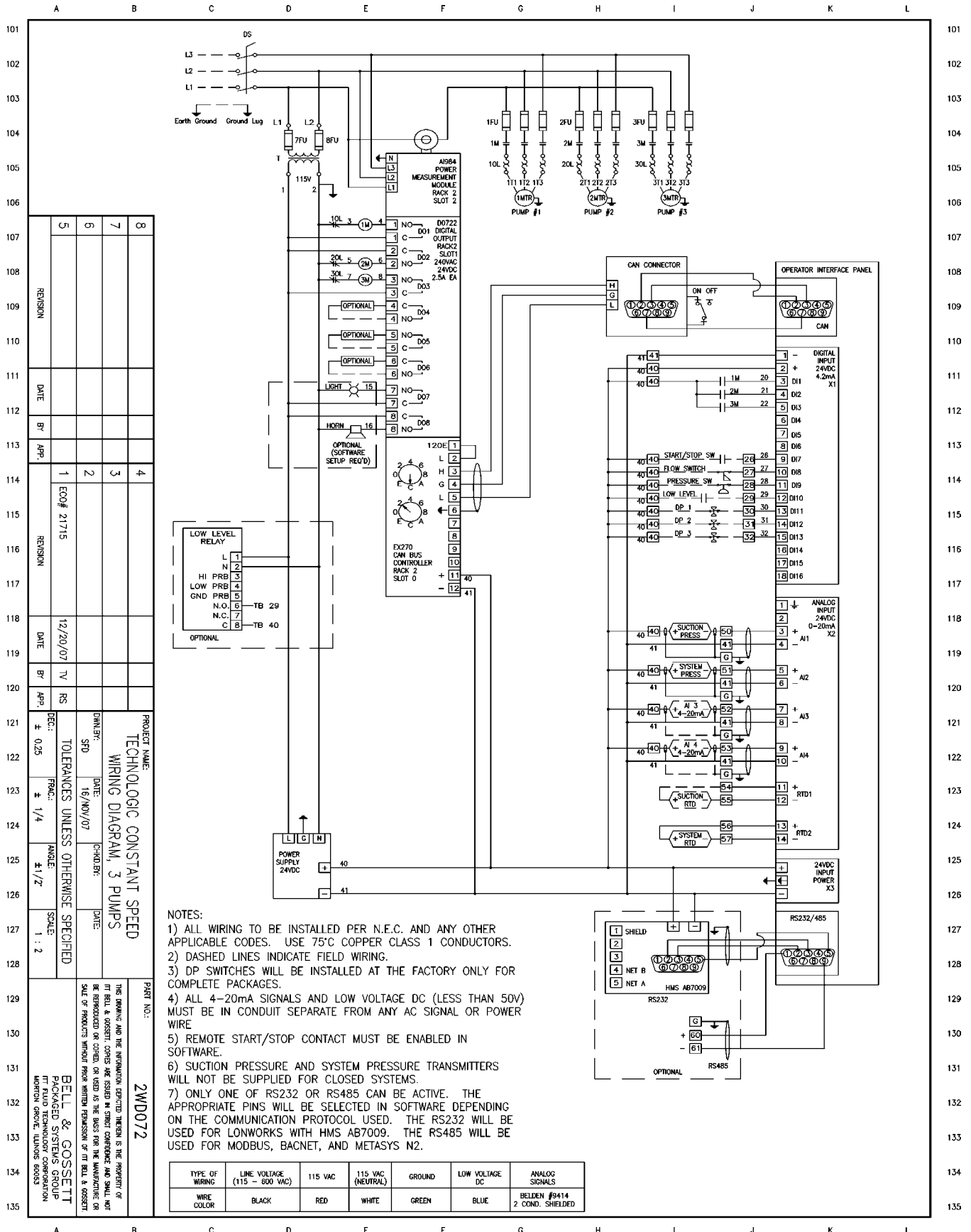

Drawing 2: Typical Technologic Constant Speed Pump Controller Wiring Diagram

Xylem |'zīləm|

- 1) The tissue in plants that brings water upward from the roots;
- 2) a leading global water technology company.

We're a global team unified in a common purpose: creating advanced technology solutions to the world's water challenges. Developing new technologies that will improve the way water is used, conserved, and re-used in the future is central to our work. Our products and services move, treat, analyze, monitor and return water to the environment, in public utility, industrial, residential and commercial building services, and agricultural settings. With its October 2016 acquisition of Sensus, Xylem added smart metering, network technologies and advanced data analytics for water, gas and electric utilities to its portfolio of solutions. In more than 150 countries, we have strong, long-standing relationships with customers who know us for our powerful combination of leading product brands and applications expertise with a strong focus on developing comprehensive, sustainable solutions.

For more information on how Xylem can help you, go to www.xylem.com



Xylem Inc.
2881 East Bayard Street Ext., Suite A
Seneca Falls, NY 13148
Phone: (844) XYL-PUMP [844-995-7867]
Fax: (888) 322-5877
www.bellgossett.com

Bell & Gossett is a trademark of Xylem Inc. or one of its subsidiaries.
© 2017 Xylem Inc. S14367C October 2017