

THIS MANUAL IS FOR TECHNICIAN USE ONLY

XLS™ Integrated Pump Controller

HUMAN MACHINE INTERFACE (HMI) FOR THE TECHNOFORCE™ BOOSTER SYSTEM
TECHNICIAN GUIDE



Bell & Gossett

a xylem brand

Acknowledgements

All materials ©2014 by Xylem Inc.

All rights reserved. No parts of this work may be reproduced in any form or by any means - graphic, electronic, or mechanical, including photocopying, recording, taping, or information storage and retrieval systems - without the written permission of the publisher.

Products that are referred to in this document may be either trademarks and/or registered trademarks of the respective owners. The publisher and the author make no claim to these trademarks. These include Microsoft, Windows, Windows NT, and ActiveX that are either registered trademarks or trademarks of Microsoft Corporation in the United States and/or other countries. ©2013 Microsoft Corporation. All rights reserved.

WHILE EVERY PRECAUTION HAS BEEN TAKEN IN THE PREPARATION OF THIS DOCUMENT, THE PUBLISHER AND THE AUTHOR ASSUME NO RESPONSIBILITY FOR ERRORS OR OMISSIONS, OR FOR DAMAGES RESULTING FROM THE USE OF INFORMATION CONTAINED IN THIS DOCUMENT OR FROM THE USE OF PROGRAMS AND SOURCE CODE THAT MAY ACCOMPANY IT. IN NO EVENT SHALL THE PUBLISHER AND THE AUTHOR BE LIABLE FOR ANY LOSS OF PROFIT OR ANY OTHER COMMERCIAL DAMAGE CAUSED OR ALLEGED TO HAVE BEEN CAUSED DIRECTLY OR INDIRECTLY BY THIS DOCUMENT.

Table of Contents

ACKNOWLEDGEMENTS	2	WEB REPORTS	31
INTRODUCTION	5	Log on to Web Reports.....	31
HMI OVERVIEW	5	Web Reports Menu.....	31
TYPICAL PUMPING OPERATION	6	Trend View	32
TOUCH-SCREEN PANEL OPERATION	6	Alarms Report	32
SYSTEM BOOT UP	6	Historical Report.....	32
BOOSTER SCREEN LAYOUT	7	Usage Report	33
USER TYPES	7	Smart Phone and PDA access:	33
TOUCH PANEL LOGIN	7	APPENDIX A - GLOSSARY OF TERMS	34
HOME SCREEN NAVIGATION	9	APPENDIX B - NETWORKING OPTIONS	37
PUMP STATUS	9	APPENDIX C - TYPICAL ALARMS CONFIGURATION..	38
STATION DISCHARGE STATUS	9	APPENDIX D - EMAIL TROUBLESHOOTING	39
MODES OF OPERATION	10	DETERMINING THE IP ADDRESS OF THE SMTP	
Auto.....	10	SERVER.....	39
Manual.....	10	TROUBLESHOOTING GENERAL EMAIL FAILURES	41
ALTERNATION SETUP.....	11	Troubleshooting Email SET Failures	41
LOW PRESSURE OVERRIDE.....	11	Troubleshooting Email Send Failures	42
SYSTEM VIEW	12	APPENDIX E: COMPUTER SETUP AND DETERMINING	
Trends	12	THE IP ADDRESS OF YOUR PUMP STATION	44
Technical Overview	13	DETERMINING THE IP ADDRESS:.....	46
ALARM TAB	13	APPENDIX F – GENERAL NETWORKING AND ROUTER	
SETPOINT TAB.....	14	CONFIGURATION DISCUSSION:	48
SERVICE TAB	15	APPENDIX G – QUICK START GUIDE:	51
Lockout Setup	15		
Events	16		
Email Setup.....	17		
Set Sync HMI-PLC Date/Time.....	18		
Security Setup	19		
Tuning.....	19		
PID Settings	19		
Supplemental Control.....	21		
Combos.....	22		
Pump Curve Configuration.....	23		
System Setup	23		
Station Information	23		
Basic Pump Information	24		
Zone Configuration.....	24		
Pump Configuration	24		
Control Options	25		
Combo Definitions.....	26		
Analog Scaling	26		
Alarm Configuration.....	26		
ENERGY TAB.....	27		
COMMUNICATIONS TAB	27		
SETUP/CONFIGURATION FILE	30		
NETWORKING AND REMOTE ACCESS	31		
Remote Software Log In.....	31		

Table of Figures/Tables

Figure 1 Connection for USB Keyboard (c).....	6	Figure 61: Combo Definitions.....	26
Figure 2: Start Up Screen.....	6	Figure 62: Analog Scaling.....	26
Figure 3: Basic Booster Home Screen.....	7	Figure 63: Analog Scaling Channel Detail.....	26
Figure 4: Guest Service Screen.....	7	Figure 64: Alarm Configuration.....	27
Figure 5: Supervisor Service Screen.....	8	Figure 65: Energy Home Screen.....	27
Figure 6: Log In Screen.....	8	Figure 66: Flow Totals Overview.....	27
Figure 7: Log In Keypad.....	8	Figure 67: Daily Flow Totals Overview.....	27
Figure 8: Technician Service Screen.....	8	Figure 68: Communications Home Screen.....	28
Figure 9: Home Screen Navigation.....	9	Figure 69: Communications Protocol Selection.....	28
Figure 10: Pump Symbols.....	9	Figure 70: Communications Protocol Selection 2.....	28
Figure 11: Pump Switch Screen.....	9	Figure 71: Communications Protocol Selection 3.....	28
Figure 12: Pump Detail.....	9	Figure 72: Active X & IP Updates.....	30
Figure 13: Pump Information.....	9	Figure 73: WinCE Remote Access.....	31
Figure 14: Station Discharge Status.....	9	Figure 74: Web Reports Menu.....	32
Figure 15: Basic Booster Idle Screen.....	10	Figure 75: Trends View.....	32
Figure 16: Basic Booster Manual Screen.....	10	Figure 76: Alarms & Events.....	32
Figure 17: Manual On/Off.....	10	Figure 77: Historical Reports.....	33
Figure 18: Manual Pump Control Screen.....	10	Figure 78: Usage Reports.....	33
Figure 19: Default Alternation Screen.....	11		
Figure 20: Example Alternation Screen.....	11	Table 1: MODBUS Settings.....	29
Figure 21: Low Pressure Override.....	11	Table 2: BacNet Settings.....	30
Figure 22: Trends Screen.....	12		
Figure 23: Configure Period.....	12		
Figure 24: Configure Data.....	12		
Figure 25: Technical Overview.....	13		
Figure 26: Combo Information.....	13		
Figure 27: Combo Information Detail.....	13		
Figure 28: Alarms Home Screen.....	13		
Figure 29: Period Screen.....	14		
Figure 30: Alarm Warning.....	14		
Figure 31: Setpoint Home Screen.....	14		
Figure 32: Setpoint Detail A.....	14		
Figure 33: Setpoint Detail B.....	14		
Figure 34: Setpoint Detail C.....	15		
Figure 35: Setpoint Detail D.....	15		
Figure 36: Setpoint Detail E.....	15		
Figure 37: Service Home Screen.....	15		
Figure 38: Lockout Screen.....	16		
Figure 39: Individual Lockout Setup.....	16		
Figure 40: Parameter Tab in Lockout Setup.....	16		
Figure 41: Event Setup.....	16		
Figure 42: Email Settings.....	18		
Figure 43: Set/Sync Screen.....	18		
Figure 44: Sync Pop-up Detail.....	18		
Figure 45: Clear/Update Totalizers.....	18		
Figure 46: Security Setup Home Screen.....	19		
Figure 47: User Setup.....	19		
Figure 48: Tuning Home Screen.....	19		
Figure 49: Tuning PID Drop Down.....	19		
Figure 50: Supplemental Control Home Screen.....	21		
Figure 51: Combos Home Screen.....	22		
Figure 52: Pump Configuration Home Screen.....	23		
Figure 53: Station Information.....	23		
Figure 54: Configuration File.....	23		
Figure 55: File Browser.....	23		
Figure 56: Basic Pump Information.....	24		
Figure 57: Zone Totalizer Setup.....	24		
Figure 58: Service Pump Configuration.....	25		
Figure 59: Service Pump Type Configuration.....	25		
Figure 60: Control Options.....	25		

For additional questions, contact your local Bell & Gossett Representative.

Introduction

This manual is written for Bell & Gossett Technicians and is an introduction to the XLS HMI (Human Machine Interface). The HMI is a browser-based system which allows the user to interact with the settings and reports of the pumping system. This manual only covers the HMI aspect of the system. Please see the TechnoForce Booster Instruction Manual for any questions not related to the HMI.

This manual assumes that the reader has used and understands basic Internet browser operation and has used a Microsoft® Windows Operating System GUI (Graphical User Interface), such as Windows 2000®, Windows NT®, Windows ME®, or Windows XP®. This device uses Windows CE-as an operating system (OS). Windows CE® is a component-based version of the Windows operating system designed for embedded devices, such as PDAs or touch-panel displays.

This manual also assumes the user has some basic knowledge of pumps and pumping systems.

Note: Button names are shown enclosed in square brackets, such as [Button], whenever the actual key or button graphic is not displayed.

The interface is displayed at the pumping station on the HMI. Users make selections of the options and enter data using a stylus or hands, and tapping directly on the HMI's color, touch-screen panel.

CAUTION: Equipment Damage Hazard

Only use a stylus or clean hands on the HMI touch-panel device to access screens and enter data. Use of any other tool, sharp object, or contact with dirt or chemicals can cause damage to the screen.

Failure to follow these instructions indicates a potentially hazardous situation, which, if not avoided, may result in equipment damage and void any warranty.

CAUTION: Equipment Damage Hazard

To clean the equipment:

Disconnect the equipment from any AC outlet, use a clean damp cloth. Do not use liquid or spray detergents for cleaning.

Failure to follow these instructions indicates a potentially hazardous situation, which, if not avoided, may result in equipment damage and void any warranty.

HMI Overview

The XLS is a modular and scalable architecture that is used by the HMI (Human Machine Interface) to control a station's pumps. It handles a variety of changing conditions to operate the booster station using a touch panel display.

A web-based version of the application is operational on the HMI and permits the user to supervise the pumping station's operation remotely at any time from any internet-accessible computer. The web-based screens are identical to the screens viewed on the HMI. Web Reports can also be viewed and printed by users who access the HMI interface via the internet.

Data and information is exchanged with the pumping station's master controller, also called a Programmable Logic Controller (PLC), located physically in the NEMA rated enclosure. The communication exchanges are made over Ethernet. The PLC is responsible for the real-time control of the system. The HMI provides a graphical user interface (GUI) which permits the pumping station to be monitored, and allows the controls or variables to be changed when necessary. All monitoring and control information can be sent to the pumping station remotely over the Internet using the web-based version. This basic communication between the remote user, the HMI, and the pumping station is illustrated below.

Typical Pumping Operation

Several common control variables including flow, pressure, and level can be used for operating a booster system. Pump starts and stops are based on the changes in these control variables. A VFD (Variable Frequency Drive) is used to regulate the speed of the pumps, replacing the function of a control valve. Pressure recovery can be made smoothly, resulting in power and cost savings.

When pressure is used as the key process variable, the VFD pumping system constantly monitors pressure to maintain the required demand. Pump starts and stops are based on the changes in the system pressure.

Other configurations are also possible. Consult your Bell & Gossett Representative for proper operation of your system.

Touch-Screen Panel Operation

This XLS HMI device manual describes the operation of the touch-panel display, located on the enclosure door of the control unit of the booster station.

- Use a stylus to tap the buttons or fields when using the touch-screen panel.
- Use the Enhanced Key Pad to enter text or numbers in blank fields. Tap and hold the stylus in a blank field to open the Enhanced Key Pad pop up screen.
- A USB Keyboard may also be used instead of the Enhanced Key Pad. Plug in the USB Keyboard into the back of the display.



Danger: Electric Shock Hazard

Disconnect power before opening any electrical enclosure. Any procedure requiring opening an electrical enclosure must be performed by qualified personnel only.

Failure to follow this guideline could result in injury or death.

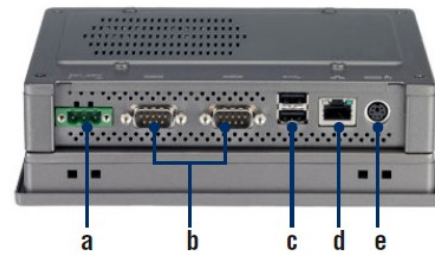

- a. Power Receptor
- b. COM (RS-232)
- c. USB 2.0
- d. LAN (10/100/1000)
- e. PS/2

Figure 1: Connection for USB Keyboard (c).

System Boot Up

Once the station is installed and field wiring is complete, the system is ready to start. Upon engaging power the control will start up and the HMI will boot. Once the boot up sequence is complete the user will see the station information screen.



Figure 2: Start-Up Screen

Home Screen

Once the startup screen clears the HMI will display the home screen for the configured station.

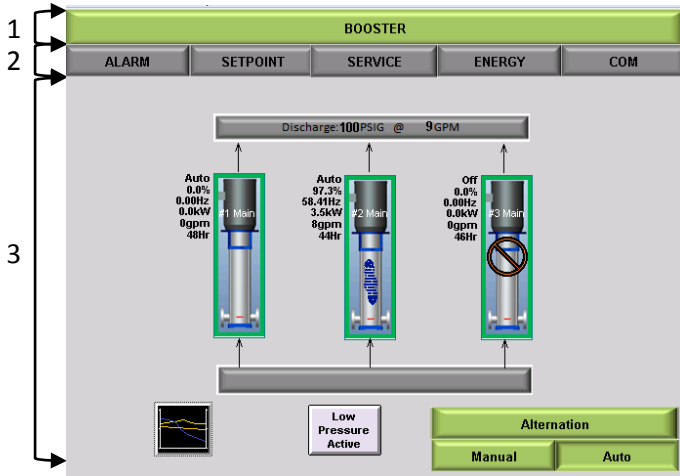

Figure 3: Basic Booster Home Screen

The application uses a three-part structure for all screens:

1. **The Header/Home Tab**, located at the top of the screen, will display the active system and will allow navigation back to the home screen at any point.
2. **The Navigation Bars**, located just below the home tab, displays buttons to tap which will navigate to other key areas of the application. The content of the navigation bar changes depending on what type of user is logged in.
3. **The Main Window**, located in the center of the screen, displays one or more panes of information about the booster station. Depending on which screen is active will depend on the information that is available to view or edit.

User Types

There are different types of users recognized by the system:

Guest: Only operation screens are accessible in view-only mode. **Users are logged in as a Guest by default.**

Supervisor: End-User configurable setup and operation screens are accessible. Supervisors must log-in using a password. The default Supervisor password is "1234". This password should be changed upon the first log in. **Ensure you do not lose this password as there is no way to recover if lost.**

Technician: All setup and operation screens are accessible. Technicians must log-in using a password. The default technician password will be provided to the certified installer at the time of installation.

Note: Some values require you to set the "Enable Writes" checkbox before you can change the values. This is a precautionary measure intended to prevent unwanted and accidental register value writes. These values are available to technicians only. Values normally accessed at the Supervisor level or lower are not affected.

Touch Panel Log In

Tap [SERVICE] from the Home Screen.

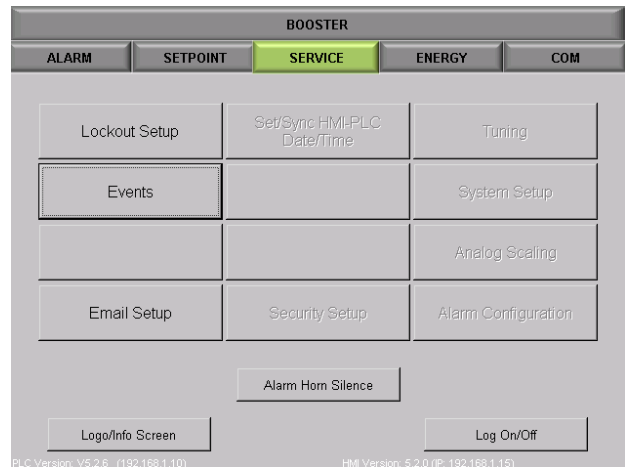

Figure 4: Guest Service Screen

Note that when logged in as a Guest certain boxes are disabled, shown in Figure 4.

When logged in as a Supervisor more options will be made available as shown in Figure 5.

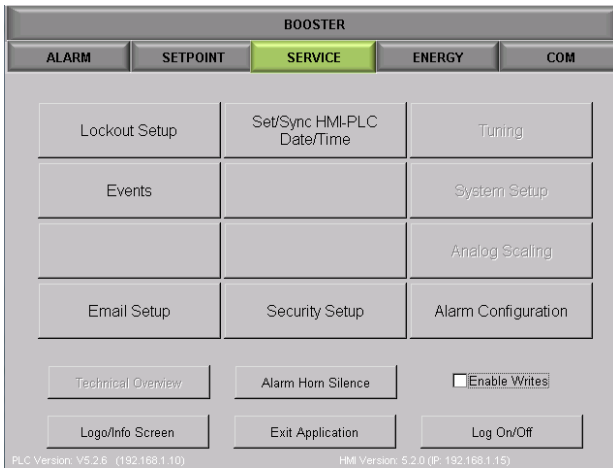

Figure 5: Supervisor Service Screen

In order to enable all of these parameters you will need to log in as Technician.

Tap [Log on/off] from the Service Screen to change User type.

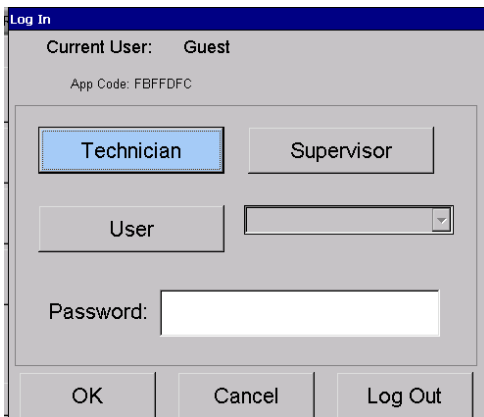

Figure 6: Log In Screen

To log in as a Technician, tap [Technician], and then tap on the empty Password field to enter the Technician password. This will bring up an enhanced screen shown in **Figure 7**.

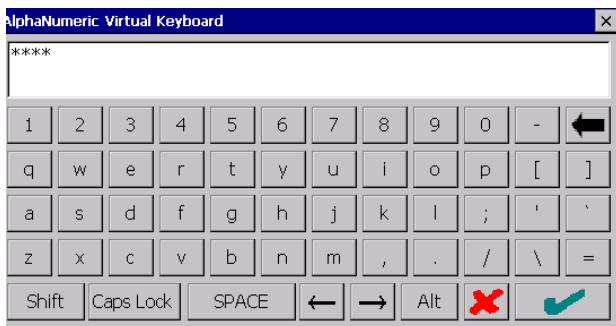



Figure 7: Log In Keypad

Enter your password and Tap  to log in, or

 to exit without logging in.

Once back to the Log In screen tap [OK] to log in or [Cancel] to abort. If Log in was successful the Service Screen should appear as in **Figure 8**.

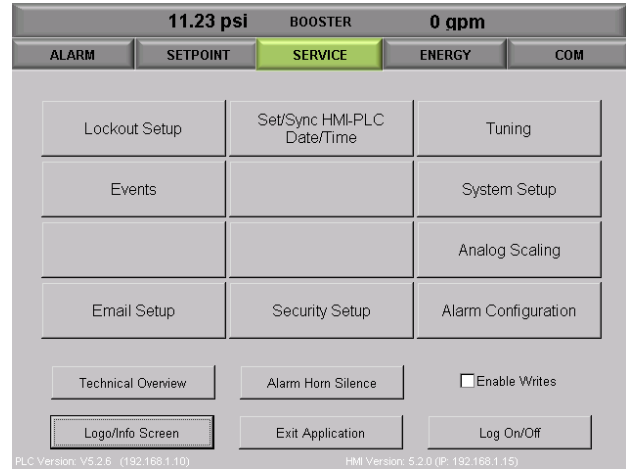

Figure 8: Technician Service Screen

Now that you are logged in as a Technician you can view or alter any of the station parameters. Note that the station has been pre-configured from the factory so that changes required for station operation should be minimal. Please see the **Quick Set-up portion** of this guide for standard start-up procedure.

Tap [BOOSTER] to return to the Home Screen

Home Screen Navigation

The Booster home screen has been designed to mimic the look of the configured booster and to allow for quick visual cues for ease of navigation.

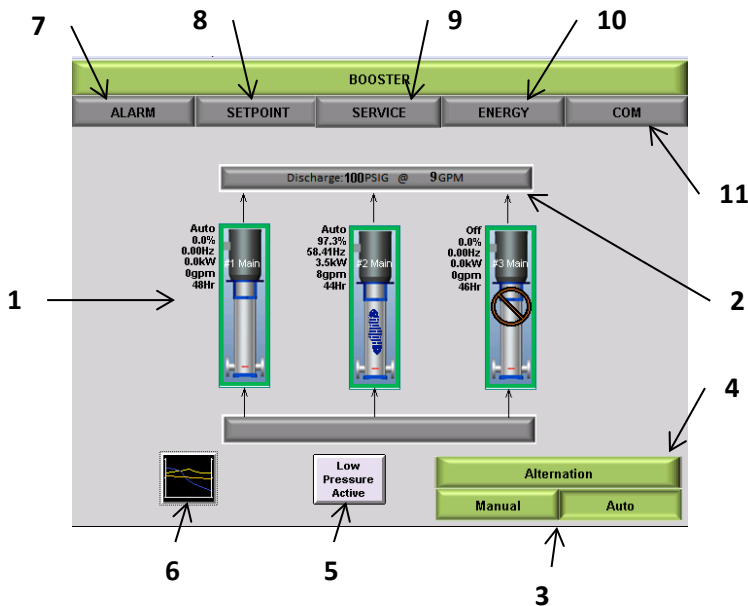

Figure 9: Home Screen Navigation

The Home screen has various buttons and information blocks detailed below.

1. Pump Status
2. Station Discharge Status
3. Modes of Operation
4. Alternation Set-up
5. Low Pressure Override
6. System View
7. Alarm Tab
8. Setpoint Tab
9. Service Tab
10. Energy Tab
11. Communications Tab

PUMP STATUS

The Individual pumps for each will have multiple means of status display both visually and with data.

1. Visual Pump Symbols:

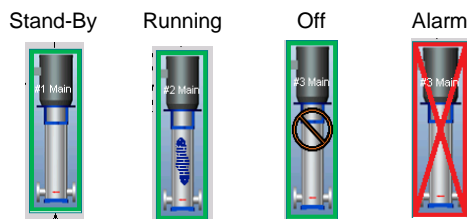



Figure 10: Pump Symbols

- a. By tapping  in either Idle or Auto Modes, an enhanced screen shown in Figure 11 will appear to set individual pump status.

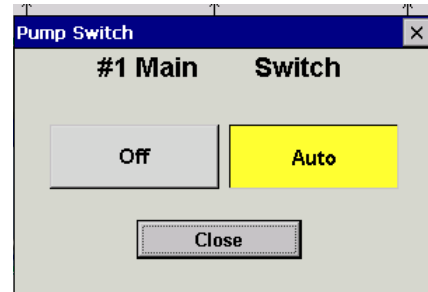



Figure 11: Pump Switch Screen

2. Pump Status Detail:

Auto	- Status
97.3%	- Percent Speed
58.41Hz	- Hertz
3.5kW	- kW
8gpm	- Flow Rate
44Hr	- Total runtime

Figure 12: Pump Detail

- a. By tapping  , an enhanced screen shown in Figure 13 will appear with more detailed information.

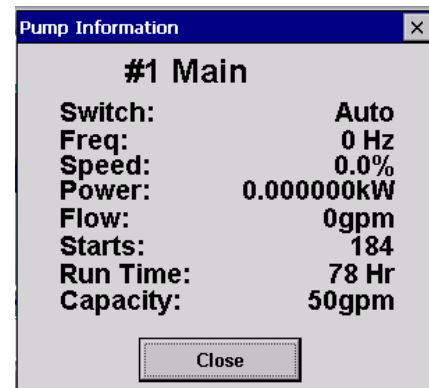

Figure 13: Pump Information

STATION DISCHARGE STATUS

The station discharge status bar will display the current discharge conditions for the station.

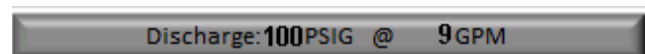

Figure 14: Station Discharge Status

MODES OF OPERATION

The HMI will display various modes of operation with dedicated screens. These modes of operation can be accessed through the interface on the home screen.

- IDLE MODE** will be active when the unit is not in [MANUAL] or [AUTO] and the pumps will not be allowed run.

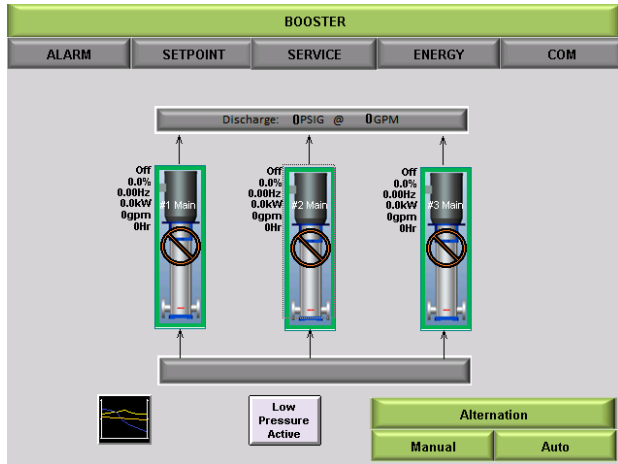

Figure 15: Basic Booster Idle Screen

- Auto Mode** is activated /deactivated by tapping [AUTO]. To enter or exit this mode of operation simply tap [AUTO] from the IDLE screen. ***Details on setting up the station for proper AUTO operation are detailed in the startup procedure.**
- Manual Mode** is activated/deactivated by tapping [MANUAL] from the home screen. When activated, a dedicated screen will appear as shown in **Figure 16** to allow manual operation of individual pumps.

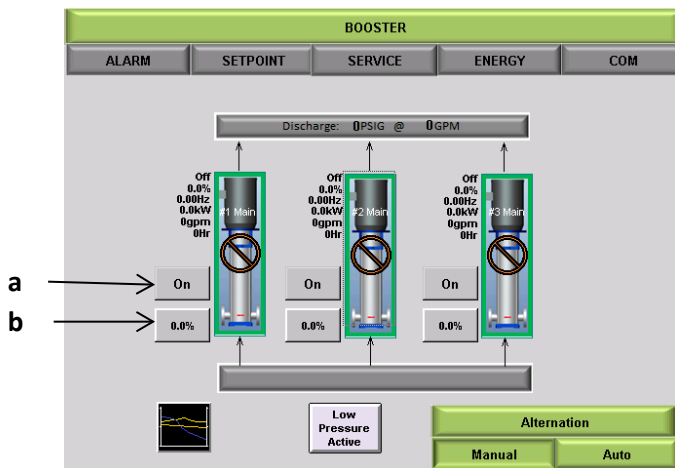

Figure 16: Basic Booster Manual Screen

- [ON], allows for the manual ability to turn on/off the pump.

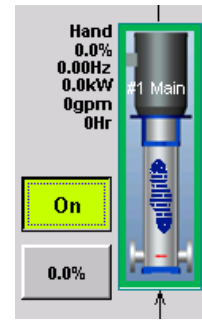

Figure 17: Manual on/off

- The **PERCENT SPEED** displays the current set speed.

By tapping , an Enhanced Screen shown in **Figure 18** will appear and allow for manual control of the pump speed and status.

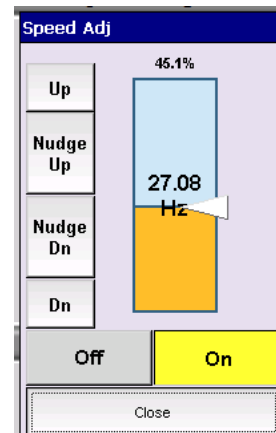

Figure 18: Manual Pump Control Screen

ALTERNATION SET UP

The default alternation sequence is set from the factory to alternate the pumps every time a pump is turned off by the system. The control will automatically select the pump with the lowest number of run-hours every time a pump is staged on/off.

By tapping [ALTERNATION] an enhanced screen shown in **Figure 19** will appear that allows the modification of the alternation sequence for the station.

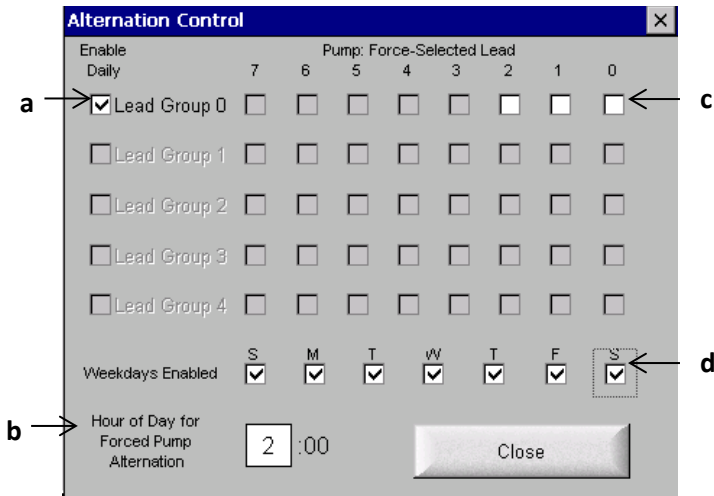

Figure 19: Default Alternation Screen

The Alternation screen will allow the user to force alternation of a given pump during a particular time of day.

- Enables forced alternation for given pump group based on scheduled parameters in remaining fields. Leaving this unchecked will disable the forced alternation based on time of day. The pumps will still alternate as they turn on and off due to demand.
- Sets the time for forcing alternation.
- This section will default to the “unchecked” position as shown. By “checking” one of these boxes, you will be forcing that pump to be the lead pump when alternation occurs. **Only one box needs to be checked.** If multiple boxes are checked then the first checked pump from the right will always be the lead pump.
- Sets the day in which the system will force alternation

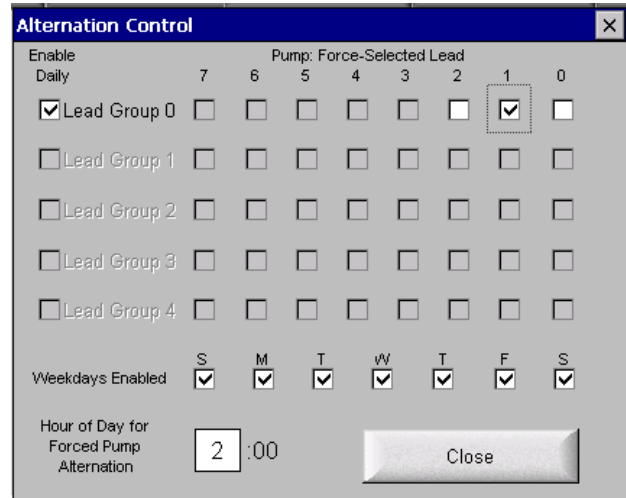

Figure 20: Example Alternation Screen

In the above example alternation will occur normally anytime the pumps are turned off. However, alternation will be **forced** daily at 2:00 a.m. with pump 1 established as the lead.

LOW PRESSURE OVERRIDE

The Low Pressure Override button allows the station's low pressure safeties to be disabled for system service. This function will allow for the technician to perform system checks without low pressure alarms shutting the station down. **This feature should never be left on while the station is unattended.**

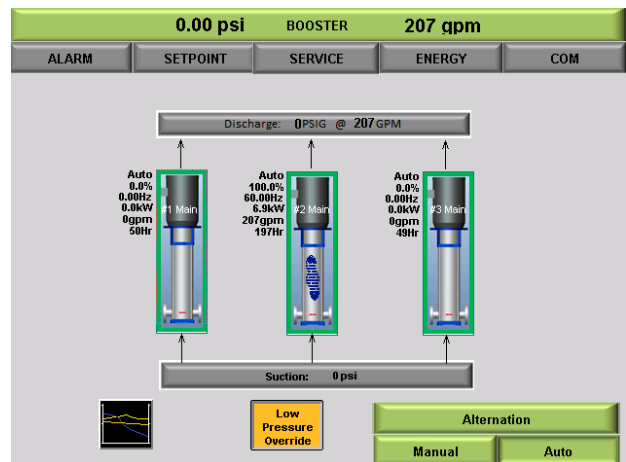



Figure 21: Low Pressure Override

SYSTEM VIEW & TRENDS

By tapping  from home screen, System View accesses color-coded operational trends or historical data for several system variables such as flow, pressure, speed, and setpoint.

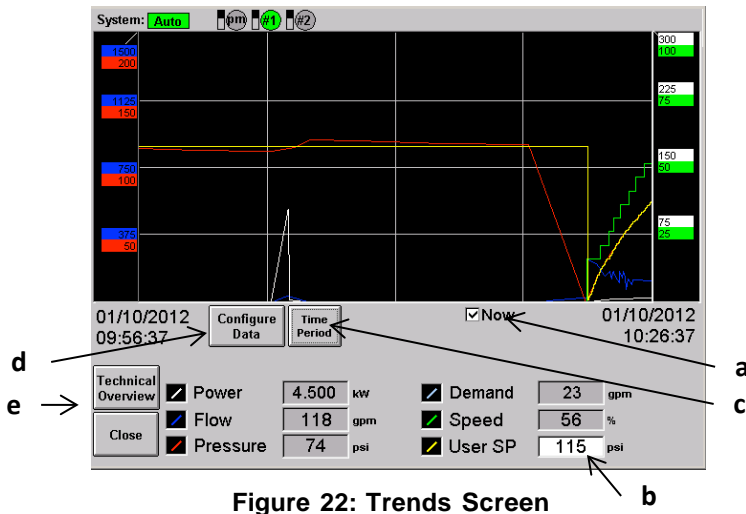

Figure 22: Trends Screen

You can turn on and off logged channels on the viewer by tapping any of the values at the bottom of the screen.

Power readings may not be available on all systems. Also on some systems a power reading of 0 will cause the Power display to disappear, and will reappear when power readings return.

- The trends will be shown for the Duration value, ending at the current time. When 'Now' is checked, the system defaults to the current date and time.

If 'Now' has been checked, 'Duration' is the only editable field under [Time Period]. For viewing historical data, uncheck 'Now'.

Enter the start date and time, along with duration to view data for desired time. Tap [Apply] to apply changes or [Close] to cancel any changes.

NOTE: If 'Now' is left unchecked, the system does not default back to the current date and time.

b. User SP field

By tapping in the "User SP" from the System View you can adjust the system Normal Set Point.

c. Time Period

By tapping [Time Period] from the System View an enhanced screen allows you to set a date and duration for viewing system information.

Figure 23: Configure Period

d. Configure Data

By tapping [Configure Data] for the System View menu will bring up an enhanced screen that will allow you to change way the data is displayed on the trends screen.

Channel	Value	Unit	Max
<input checked="" type="checkbox"/> Pressure	250	psi	100.0%
<input checked="" type="checkbox"/> Station Flow	3000	gpm	100.0%
<input checked="" type="checkbox"/> Speed	100	%	100.0%
<input checked="" type="checkbox"/> High Zone	20	gpm	100.0%
<input checked="" type="checkbox"/> Low Zone	0	gpm	100.0%
<input checked="" type="checkbox"/> City Fill	0	gpm	100.0%
<input checked="" type="checkbox"/> Well Total	0	gpm	100.0%
<input checked="" type="checkbox"/> Well Dwnstr	0	gpm	100.0%
<input checked="" type="checkbox"/> Well Lakefill	4	gpm	100.0%
<input type="checkbox"/> VFD 1 Pwr	37	kw	100.0%
<input type="checkbox"/> Power	300	kw	300
<input type="checkbox"/> Demand (Lynx)			

Figure 24: Configure Data

Check the box next to the data you want to show. Not all data is available for all systems. Use the slider bar on the right to adjust the graph scaling to a value that makes it most comfortable to read.

100% means the graph scale is the same as the analog scaling max value. 110% means the graph scaling is 110% of the analog max

scaling for the channel. The exception here is the KW reading, which is an absolute number because KW is read directly, rather than scaled.

Click "Channels" to access the calibration screen directly from the "Configure Data" screen.

This screen is accessible also from "Setup" -> "Options Setup" and is discussed in detail in that section.

e. Technical Overview

By tapping [Technical Overview] a new detail screen shown in **Figure 25** appears showing system operation.

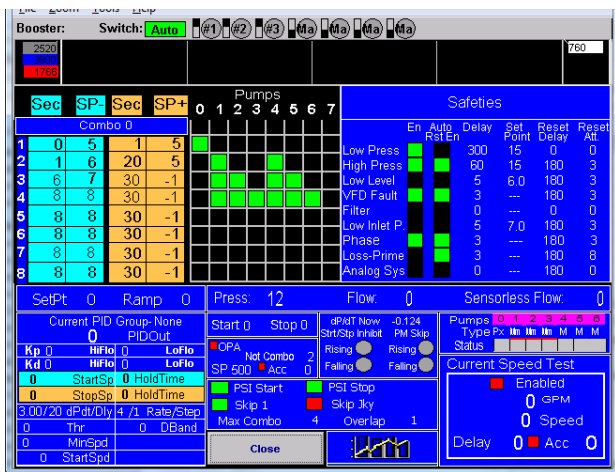

Figure 25: Technical Overview

This screen shows an overview of the configuration of the station. Most data that is necessary for tuning is shown, and the settings page for the information can be accessed by touching the value. For technicians, the fields available on this screen should be fairly self-explanatory. However, some fields can use some clarification:

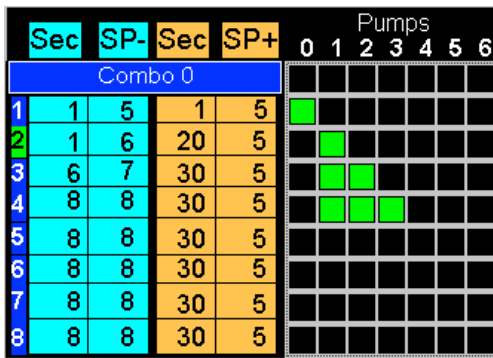

Figure 26: Combo Information

This field shows, from left to right, the current combo (highlighted), start time, psi below setpoint, stop time and psi above setpoint to stop, for each combo. To the right is a table detailing the pumps to run in each combo. The example above shows combo 1 consists of the PM Pump, Combo 2 consists of pump 1 (or any other single pump in the same group), combo 3 is two main pumps, and combo 4 is 3 main pumps.



Figure 27: Combo Information

This shows the Overpressure accumulator settings. "Not Combo" indicates that OPA will operate at any combo level above 2.

ALARMS

The [ALARMS] tab will take you to the Alarms detail screen.

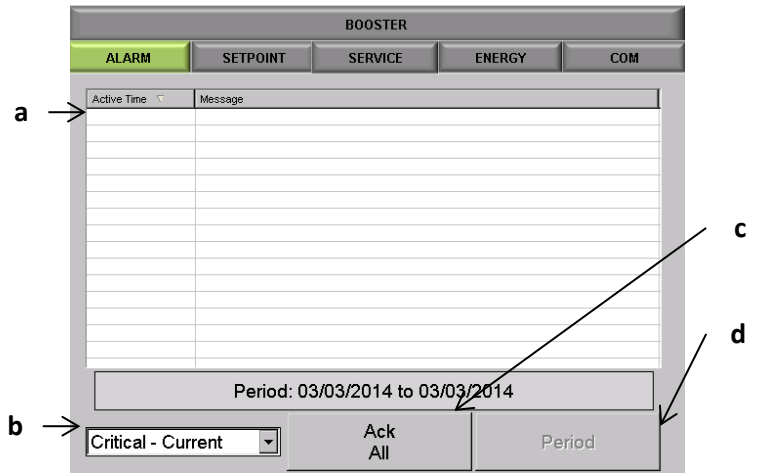

Figure 28: Alarms Home Screen

- a. The Alarm history field will display particular alarms based on the drop down selection detail in (b). The time of the alarm and the type of alarm will be displayed.
- b. Drop down selection that will allow you to sort alarms
 - i. Critical – Current (current day)
 - ii. Critical – History
 - iii. Non-Critical

- c. The [Ack All] button will clear any alarms that are currently active.
- d. Tapping [Period], available in ‘Critical – History’ and ‘Non-Critical’ modes, will open an enhanced screen shown in **Figure 29** to allow for the display of only alarms during a given range.

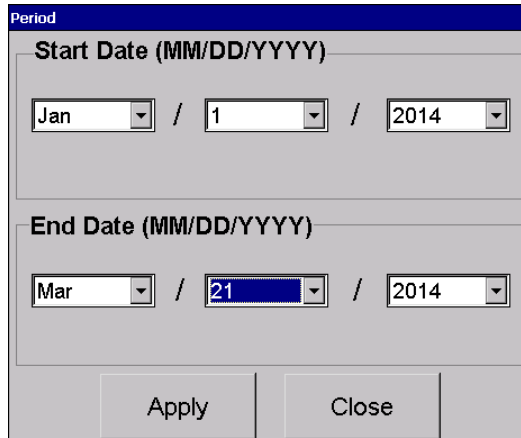

Figure 29: Period Screen

If an alarm is active the Home screen will also display various visual warnings to alert the system status

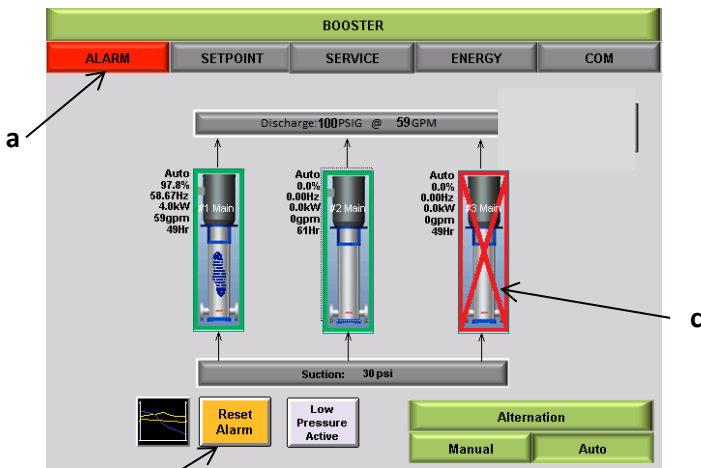

Figure 30: Alarm Warning

- a. The [ALARM] will turn red to alert that there is an active alarm.
- b. [Reset Alarm] will flash from yellow to red to indicate there is an active alarm. By tapping [Reset Alarm], the alarm will be acknowledged.
- c. The pump status will show an alarm state

SETPOINTS

The [SETPOINTS] tab will take you to the Setpoint detail screen. From this screen you will be able to view the station setpoints along with the current values of certain parameters.

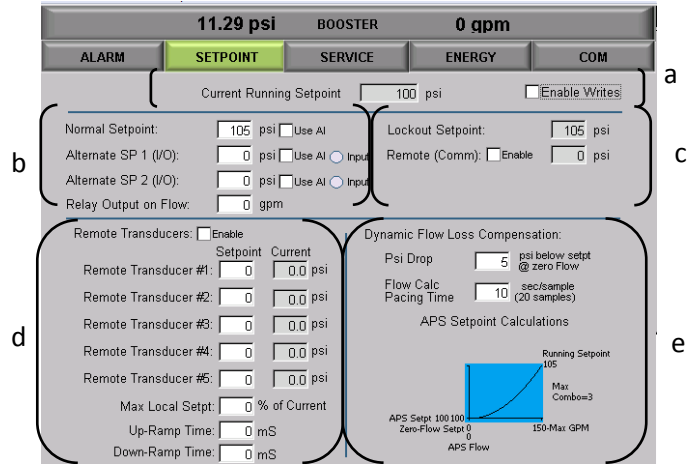

Figure 31: Setpoint Home Screen

- a. This portion of the screen displays the current running set point of the station and the ‘enable writes’ check box. By checking this box any changes made while in this screen will be saved. By leaving it unchecked no changes can be made.



Figure 32: Setpoint Detail A

- b. This portion of the screen will display the current set points being used by the system. When tapping in the numbered area an enhanced keypad will appear that will allow you to change the current value.

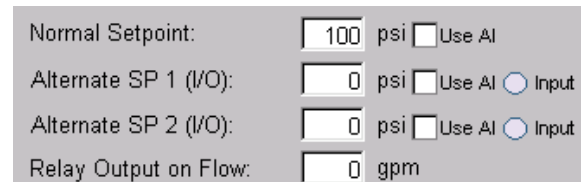

Figure 33: Setpoint Detail B

If factory configured, checking the ‘‘Use AI’’ check box will allow control by a factory configured Analog Input. This input is separate from the settings for remote transducers or BMS override. If you do not have an external AI configured, these boxes should remain unchecked.

The ‘‘Input’’ indicator will be active if that current input is on.

- c. **“Lockout Setpoint”** will display what the Lockout system has identified as the required setpoint.

“Remote (Comm)” enable is the setpoint being communicated by the remote communication system. The enable box **must** be checked in order for the remote communication system to adjust the system set point.

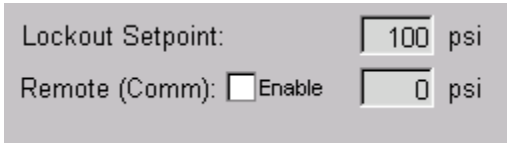

Figure 34: Setpoint Detail C

- d. This portion of the screen will display the Remote Transducer Settings. The remote transducers are enabled in the System Setup - Control Options section. If you have configured/enabled the remote transducers the “Current” box will display a value. If not it will show 0.0. By checking the enable box the system will use the configured remote transducers.

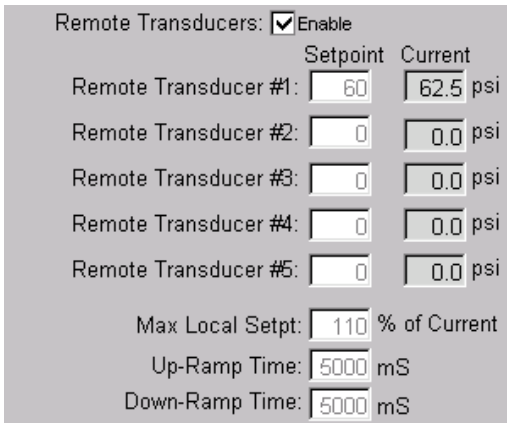

Figure 35: Setpoint Detail D

- e. This portion of the screen displays the Dynamic Flow Compensation set up.

“Psi Drop” is the setpoint for the calculated building losses in the system.

“Flow Calc Pacing Time” is the setpoint for the rate at which the “Current Running Setpoint” will change due to changes in system flow.

The graph is a representation of system curve and the cross hairs will display where the station is currently operating.

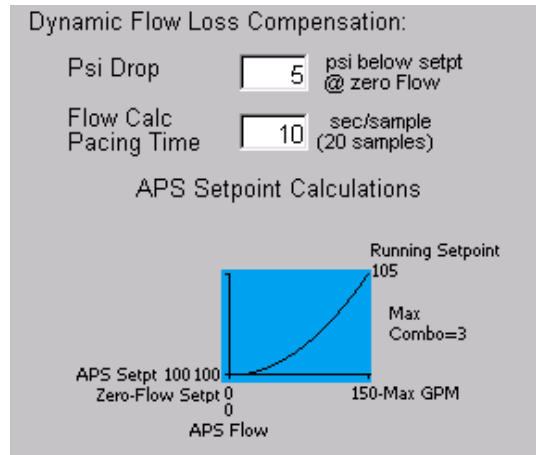

Figure 36: Setpoint Detail E

SERVICE

The [SERVICE] tab will take you to the Service detail screen. From this screen you will be able to access all of the setup parameters for the station detailed in this section.

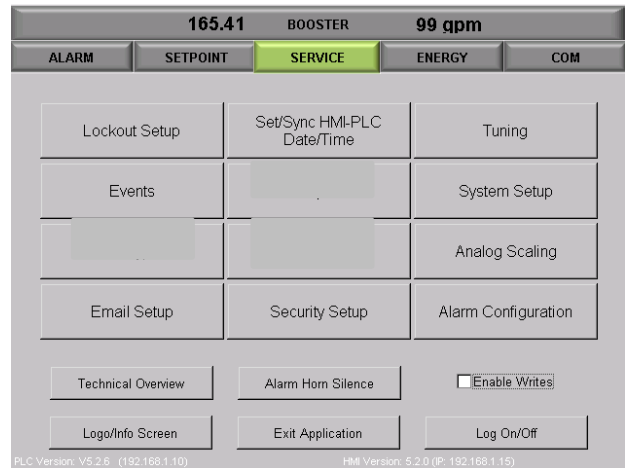

Figure 37: Service Home Screen

1. [Lockout Setup]

Tap [Lockout Setup] from the SERVICE Menu. The Lockout Setup will allow the station setpoints to be scheduled during certain periods. An example of using this parameter would be for scheduling operation during “unoccupied” periods when demand will be less.

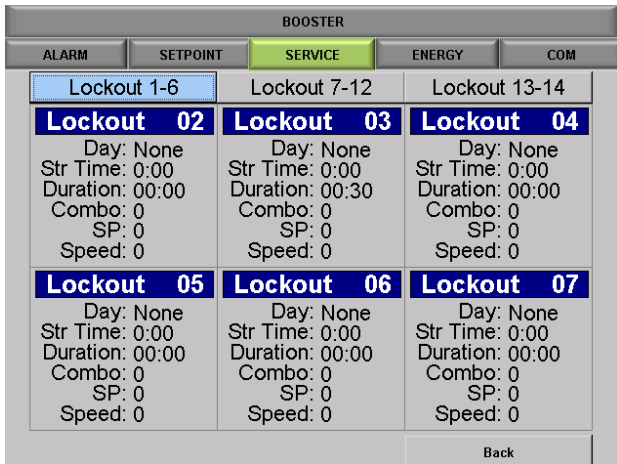

Figure 38: Lockout Screen

Individual lockouts may be setup by tapping over each lockout inset. Tapping any inset opens a configuration window. The day, start time, and duration may be entered in the interval tab at the top. In the parameter tab, the combo number, setpoint, and speed can be entered. Tap [Apply] to save settings or [Close] to discard any changes.

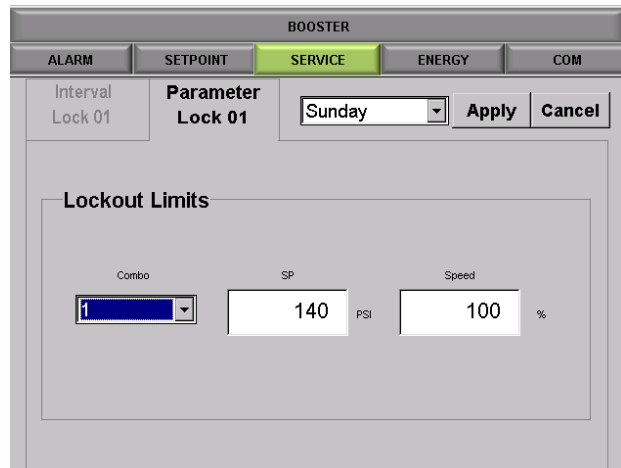

Figure 40: Parameter Tab in Lockout Setup

The Parameter tab enables a user to define Combo number, maximum pressure, and maximum speed in RPM

2. [Events]

By tapping [Events] you will be taken to the Events home screen shown in **Figure 41**. This page will detail any event that has happened within the given period.

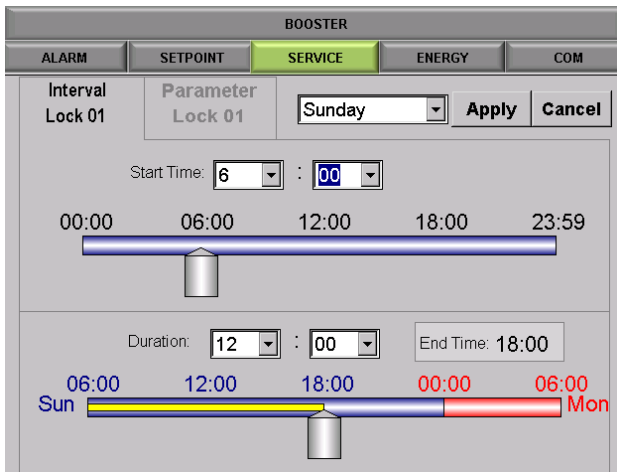

Figure 39: Individual Lockout Setup

The screen shown in Figure 39 sets up a lockout for Sunday beginning at 6:00 AM. The duration is set to be 12 hours. Thus this lockout will end at 6:00 PM on Sunday. The animated display gives an indication about time.

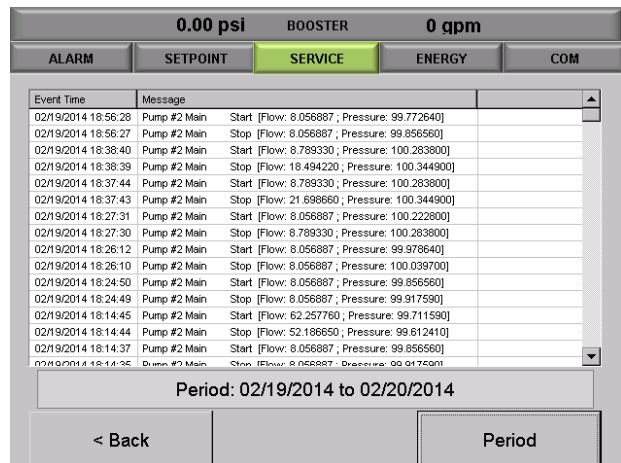

Figure 41: Event Setup

By tapping [Period] you will be able to adjust the range to show only information required.

Tapping [< Back] will take you back to the Service Home Screen.

3. [Email Setup]

This page allows you to set up email addresses where Alarm and shutdown messages will be sent. These emails will notify the user if the station has shut down or experienced a problem that the site personnel should be aware of. This way the user will be notified immediately in case of a pump station problem. If a fault occurs, an email will be sent to him.

The email settings can be configured to send emails to multiple individuals or email addresses. The vast majority of cell phone providers also allow email messages to be sent to cell phones as text messages. A list of known formats is provided below.

Enable: Check this box to enable email alarms from the Pace controls.

Use Authentication: Check this box if your email service requires POP3 authentication.

Note: The POP3 and SMTP servers will usually have the same address. Enter this value in both boxes. Sometimes the values are different so separate boxes have been provided.

To: Enter the email address where the alarm messages will be sent to. Multiple email addresses can be entered by separating the email addresses with a semicolon.

Examples:

Me@gmail.com;
TheBoss@test.com; SecondGuy@test.com;
555555555@verizon.net.

The following list shows email address formats for various cell carriers. Sending an email to these addresses will generate an SMS text message to the cellular phone where “phonenumber” is the 10 digit phone number of the user.

T-Mobile:

phonenumber@tmomail.net

Virgin Mobile:

phonenumber@vmobl.com

Cingular:

phonenumber@cingularme.com

Sprint:

phonenumber@messaging.sprintpcs.com

Verizon: phonenumber@vtext.com

Nextel: phonenumber@messaging.nextel.com

US Cellular: phonenumber@email.uscc.net

SunCom: phonenumber@tms.suncom.com

Powertel: phonenumber@ptel.net

AT&T: phonenumber@txt.att.net

Alltel: phonenumber@message.alltel.com

Metro PCS:

phonenumber@MyMetroPcs.com

SMTP: Enter the IP address of the SMTP server you will be using. Windows CE devices require the IP address rather than the server name.

See “Determining the IP address of the SMTP server” in Appendix F for these instructions.

From: Enter the complete email address used for this service. Most email servers will ignore your email request if the “From” address does not match the account.

Example: mypumpstation@runbox.com

User: For most email service providers, enter the first part of the email address without the domain name. Note that some providers require the full email address as your user name.

Example: mypumpstation

Password: The password to your email account. Example: Xlem1234

After configuring your email settings, test the setup.

Tap [Set] to load the information into the email generator. Then tap [Send]. A test email will be immediately sent to the address(es) provided.

If the colored box remains green after hitting Send, the configurations are working correctly. If the box turns red there has been an error. The number after “Status” indicates the type of error, table for which can be found in Appendix F.

Additional troubleshooting options for email configuration can also be found in Appendix F.

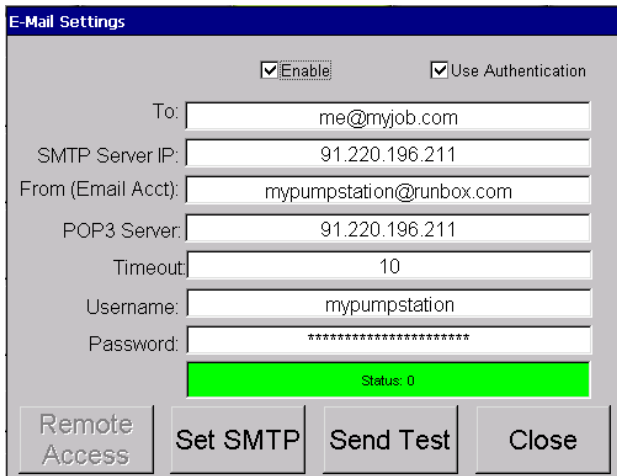

Figure 42: Email Settings

Occasionally, the settings changes here may require restarting the HMI. Try this if you experience problems getting the test email to work. This can be accomplished through cycling power or by shutting down and restarting the application. Then see appendix “F” for other troubleshooting aids.

4. [Set/Sync HMI-PLC Date/Time]

Tap [Set/Sync HMI-PLC Date/Time] from the SERVICE menu.

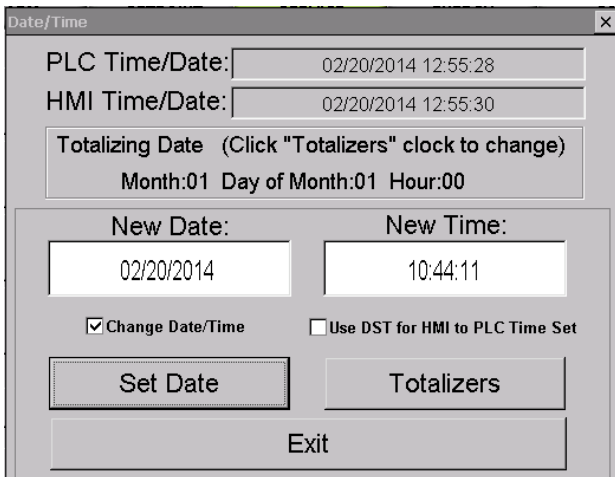

Figure 43: Set/Sync Screen

This screen allows the date and time to be set, and synchronized for the PLC and HMI. To manually set the date check “Change Date/Time”. Note the Date and Time boxes will changed to editable fields. To allow for Daylight Savings Time please check the appropriate box.

Tap [Set Date] to synchronize HMI & PLC date and time. You will get a pop up message shown below, hit [OK].

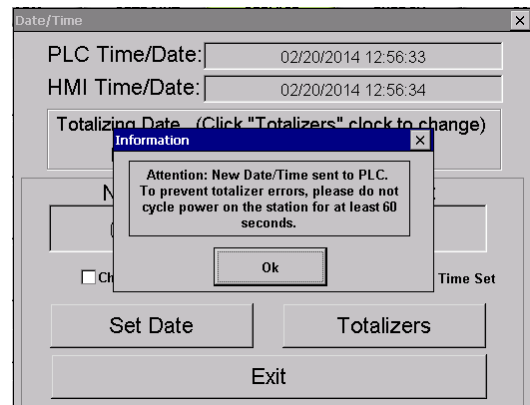

Figure 44: Sync Pop-up Detail

To adjust the totalizers tap [Totalizers]. In the new pop up you will be able to adjust the time/date when the system will totalize.

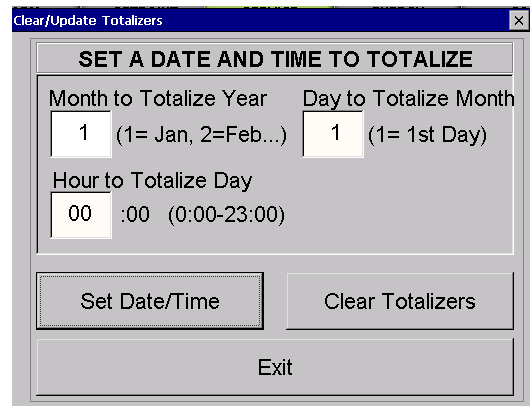

Figure 45: Clear/Update Totalizers

Use the available cells to enter the date and time. Tap [Set Date/Time] to save changes. Tap [Clear Totalizers] to clear all totalizers.

Note that when the HMI time is set, the HMI will automatically sync the PLC time once/day.

Synchronization should not be done while using the Internet-based remote client as this has the potential to negatively affect the time settings of the system. Syncing should only be performed locally.

5. [Security Setup]

Tap [Security Setup] from the SERVICE Menu.

Figure 46: Security Setup Home Screen

The Supervisor can change the password assigned to him/her, and set the number of days after which the password expires (in the editable field). To change the password, tap [Change Password] to change the supervisor password. Enter the new password in the 'Password' and 'Confirm Password' field. Tap [Apply] to save changes.

From this screen you will also be able to assign Users to the station by tapping [Setting User].

Figure 47: User Setup

Enter the desired User Name and password and tap [Apply]. The User will now be available in the User dropdown.

6. [Tuning]

Tap [Tuning] from the SERVICE Menu. The Tuning screen will allow you to set the PID and speed control settings for station operation.

Figure 48: Tuning Home Screen

Pumps using this PID Set:

The decision on which PID set to use is based on the "best" fit of pumps running on VFD and the pumps selected here.

Figure 49: Tuning PID Drop Down

Read:

Click "Read" to read the PID values from the PID group set selected (this is automatically clicked for you when you enter the screen).

Write:

Click "Write" to save the values to the PID group.

Copying PID data:

The Read/Write buttons are provided to allow the

technician to copy values from one PID group to the other. To copy, select the PID group to copy from and click "Read", then select the PID group to copy to and press "Write".

Speed Test:

Speed test is a method to shut down the lead VFD when only 1 VFD is running. The PID value is artificially reduced and the system is monitored for PID response (pressure drop).

Speed Test shutdown is initiated when flow falls below "Flow" for "Delay" seconds.

"Speed" is the speed to which the PID must drop to pass speed test and shut down the pump.

"Period" is the time between steps for the speed test routine to lower the PID output, and "Step Size" is the amount of PID drop per step.

If the speed test routine detects the PID ramping up during the test, speed test will abort and operation will return to normal until flow is again below the "Flow" setpoint for "Delay" seconds.

Discussion of Proportional and Derivative settings, high and low flow:

Configuring the proportional and derivative values is essentially a trade-off. Both these values have an impact on the system response. A high proportional value causes the system to respond faster, thus reaching the setpoint faster. At the same time, this faster response means that the system will easily overshoot the desired setpoint. This can be checked by lowering the proportional value, and increasing the derivative (d-Term) value. The derivative term controls the systems response to rapid changes in pressure, regardless of the value of the pressure. This system uses this to begin reducing VFD output speed when pressure is rising quickly, helping to avoid overshoot. The system can also detect fast pressure drops to begin increasing VFD output speed before large errors are detected, increasing the systems responsiveness.

Good starting values are 7 for proportional and 4 for derivative. Increase proportional when the system lags too long changing the speed when pressure is away from setpoint but relatively steady. Decrease proportional and increase derivative to reduce overshoot. Decrease derivative when the system becomes unsteady near setpoint under steady demand. Generally speaking, only use enough derivative to reduce overshoot.

Low and high flow settings:

The low flow and high flow settings are used together to calculate the proportional and derivative terms at any given time. The low flow settings are what the proportional and derivative terms would be if flow were 0. The High Flow settings are what the proportional and derivative terms would be if flow were greater than or equal to "Max Flow for Low/High Flow". The value to use for each parameter is calculated based on the flow at the time.

Example: Low Flow Proportional is 7, and High Flow Proportional is 9, "Max Flow for Low/High Flow" is 2000. At 1000 gpm, the proportional value will be calculated to be 8. At 1500 gpm, the proportional value will be calculated to be 8.5.

Minimum Speed:

This is the minimum speed that the system will operate the VFD under PID control. This speed should equal the minimum speed that the pump will flow water at setpoint pressure. Setting this value too high can cause over pressurization at low demands. Setting this value too low can cause the PID to hunt since the speeds below the "true" min speed are ineffective and can result in unnecessary delay in the PID when operating in these speed ranges. Note that allowances must be made for varying inlet pressure and adjustable setpoints. Generally speaking, a low Min speed is better than a too-high min speed, but the closer to "true" min speed this is set, the better the system will operate.

Control Deadband:

This value controls how far from setpoint the pressure must be before the PID responds. The units here are in 0.01 psi, so 25=0.25 psi (one quarter-pound). This smooths the PID response near setpoint. However, too large a value here will cause the system to delay response and could cause the system to "get behind" in response to a large change in demand.

Transition Control

Starting Speed:

This is the initial speed of the Main VFD when the Main Pump first starts. Should be high enough to "kick start" the pump since it is starting under unsupplied demand, but care must be taken not to force the system to overshoot under low demand situations. Start the system with demand just greater than the PM Pumps (or Jockey Pump, as supplied) capacity and adjust for minimal overshoot.

Combo Up (After XL Start):

This setting controls the speed the VFD running the main pump will be forced to when a fixed speed lag pump starts. This helps prevent overpressuring by reducing the capacity of the VFD Pump, which is then being provided by the fixed speed pump after it starts. Generally set to 1/3 the value between min speed and 32767. This speed will be held for “Hold Sec”, which is generally set to 1 (may need to increase for systems using soft-starters for fixed speed lag pumps).

Combo Down (After XL Stop):

This setting controls the speed the VFD running the main pump will be forced to when a fixed speed lag pump stops. This helps replace the capacity provided by the fixed speed pump and eliminate pressure dips when these pumps are shut off. Generally set to 2/3 the value between min speed and 32767. This speed will be held for “Hold Sec”, which is generally set to 1.

Speed at 0 psi Startup:

This setting controls the speed the VFD of the Jockey OR main will start if pressure is very low when the pump starts (see deadband below). This setting should be adjusted to be the point the pump just begins to flow water at 0 psi discharge. The actual starting speed will be calculated between this speed and “Combo Down (After XL Stop)” speed setting, depending on the actual pressure at the time of start. A function is used to calculate the speed between these points.

Threshold Deadband (psi):

This setting determines the pressure below setpoint for determining starting speed. If set to “20”, the threshold function is used to calculate starting speed when pressure is equal to or less than 20 psi below setpoint.

The VFD 1start factor corresponds to the starting speed of the first main or Jockey pump starting on VFD. A high value causes the VFD to start running at a higher speed, creating more pressure. This helps the system to reach the setpoint faster, but at the same time the system may overshoot the setpoint very quickly since the PID does not have enough time to react to the fast occurring changes. A very low value will make the system take a lot of time to reach the setpoint.

Tap [Next] to move to the next Field Setup screen

Supplemental Control

The screenshot shows the 'Supplemental Control' home screen with the following sections:

- Top Bar:** 0.00 psi, BOOSTER, 0 gpm. Navigation tabs: ALARM, SETPOINT, SERVICE (highlighted), ENERGY, COM.
- Supplemental Control Section:**
 - Overpressure Accumulator (OPA):** Enable Dp/Dt Limiting for OPA (checked). Min Combo (No OPA in this combo): 2. Trip Preset: 500.
 - Ramp Up:** Step 1 (PSI) / 4 (Sec).
 - Line Fill:** Trigger Press: 60 (% of Setpt), Max Combo: 3, Speed Step: 5 %, Steady Time: 20 sec, Deadband: 3 psi, Deadband: 15 gpm, Fault Time: 60 Sec.
 - Dp/Dt Control:** Strt/Stp Inhibit: 1.00 psi/sec, PM Skip: 3.00 psi/sec, dP/dt Holdoff after shutdown: 20 sec. Current Values: dP/dt Now: 0.000 psi/sec. Strt/Stp Inhibit: Rising (off), Falling (off). PM Skip: Rising (off), Falling (off). Enable Writes.
 - DFLC:** Psi Drop: 0 psi below setpt @ zero flow. Flow Calc Pacing Time: 10 sec/sample (20 samples).
 - APS Setpoint Calculations:** APS Setpt 100, Running Setpoint 100, Max Combo=3, Zero-Flow Setpt 0, APS Flow 150-Max GPM.
- Bottom:** < Back, Next >

Figure 50: Supplemental Control Home Screen

OPA Enable

This is a method used to shut down lag pumps operating across-the-line in a system that uses both VFD and XL (across-the-line) pumps. Check this box to enable.

The overpressure accumulator measures the overpressure, and calculates a value to add to the Overpressure Accumulator depending on this error on each program scan. The system will shut off a lag pump when “Trip Preset” is reached.

Min combo:

Combo # on which, OPA is not desired because it is preferred that the last pump stop in speed test.

Line Fill Mode

This configures how the XLS controller will respond to powering up, or being put in “Auto”, under very low pressure conditions. Under these conditions, air may be in the system and it can be dangerous to the piping to immediately start pumps and run full out to attempt to bring pressure back too setpoint too quickly.

The line fill system works by starting one main pump at a fixed frequency (calculated from Speed @ 0 psi startup) under PID control). The system will hold this speed until pressure and flow are considered “Steady” for a period of time. Then the system will increase the speed. The process continues, possibly starting additional pumps, until the max line fill pressure is reached, at which time the system switches over to “Ramp up” mode and continues.

Trigger Pressure:

Line Fill Mode will trigger below this pressure (Percentage of setpoint) when powering up or entering "Auto" from Off mode.

Max Combo:

Controls how many pumps can run under these conditions by limiting the max combo of the station in line fill.

Speed step:

Controls how much the speed of the VFD is increased during each step.

Steady time:

Controls how long pressure and flow must be "Steady" before continuing to the next step.

Deadband (psi):

How large of a pressure swing is considered "Steady".

Deadband (gpm):

How large of a flow swing is considered "Steady"

Fault Time:

How long before the systems faults, if pressure and flow cannot reach what is considered "Steady".

Ramp Up

Step (psi):

During ramp-up, the # of psi the system will step up. See "Step (sec)". Normally set to 1 psi.

Step (sec):

During ramp-up, the time between ramping the setpoint. Normally set to 4 sec.

dP/dT Control

Enable (Checkbox):

Controls whether the "dP/dT" pump start/stop control functionality is utilized. Check to utilize the rate of pressure drop when starting/stopping pumps.

Start/Stop Inhibit:

The rate at which the system will inhibit pump starts or stops as the pressure rises or drops during the decision process. Generally 0.5-1.0 is adequate to reduce pump cycling.

PM Skip:

Controls how much pressure drop will cause the system to automatically skip the PM Pump in the sequence. Fast pressure drop indicates a large demand has suddenly been applied to the irrigation system. This is used to detect the need to skip the small pressure maintenance pump so that the main pump can meet this demand as quickly as possible, avoiding unnecessary pressure dips. Start with values at 1.0 and monitor. To disable this feature but continue to use the Start/Stop inhibit system above, set this value to 10 or greater.

dP/dT Inhibit (sec):

After the main pump stops, systems will often experience short pressure dips that may cause the PM Skip system to restart the main pump. Set this value to 20 seconds to prevent the PM Skip process from restarting the main pump within this period of time.

Current dP/dT

These values are shown to assist in tuning the dP/dT system.

DFLC

This screen is the same as found in the SETPOINT section detailed earlier.

Combos

This screen allows you to configure various options in a combo.

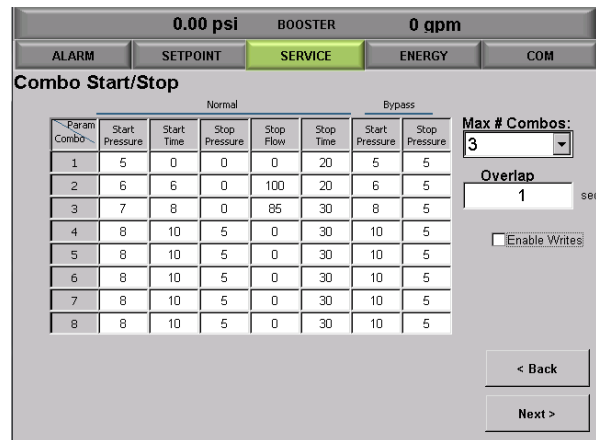

Figure 51: Combo Home Screen

Select the maximum number of combos (up to eight). For Combo 0, which is the 'no pump' combo, all values except Overlap gray out. A brief description of all parameters follows.

1. Start Pressure: number of seconds the station delays before the start of the specified combo, once ΔP has been reached
2. Start Time:
3. Stop Pressure: number of seconds the station delays before it stops the specified combo, once ΔP has been exceeded.
4. Stop Flow:
5. Stop Time:

Tap [Next] to move to the next Field Setup screen

Pump Curve Configuration

This screen allows you to load/reload the individual pump curves for the station. **Please note that the Booster station is pre-configured at the factory based on the selected pumps. Any changes could be detrimental to station performance.**

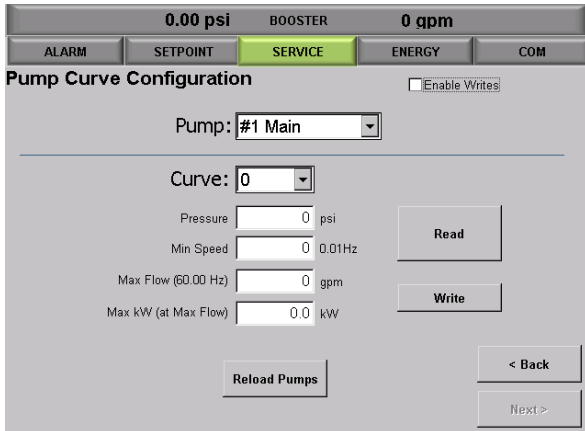

Figure 52: Pump Configuration Home Screen

7. [System Setup]

Tap [System Setup] from the SERVICE Menu.

NOTE: The screens described below will only be displayed if they are applicable to the current system.

Station Information

Enter the job information such as 'Job Number', 'Job Name', 'Main PLC IP (usually 192.168.1.10)', and 'Phone Number'. Notice that the fields 'HMI Version' and 'PLC Version' have been grayed out, and are not editable.

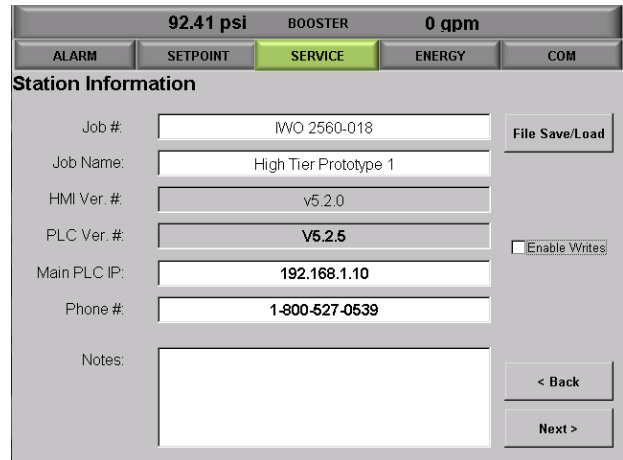

Figure 53: Station Information

You have the option of loading or saving current setpoints to and from an external drive as well by tapping [File Save/Load].

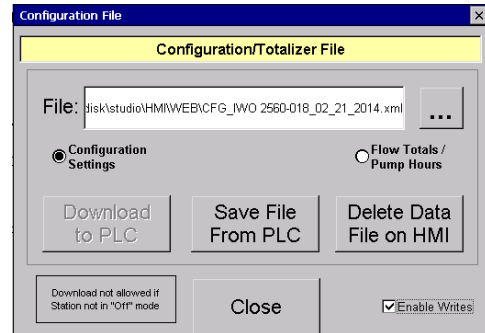

Figure 54: Configuration File

Type the file name or browse for it using [...].

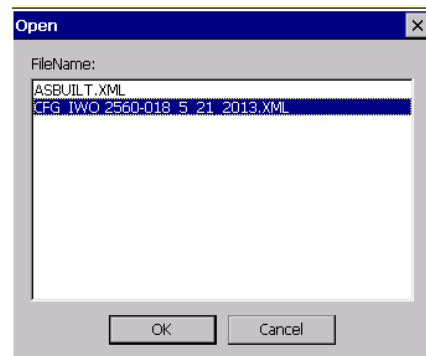

Figure 55: File Browser

The Configuration File screen lets you download an XML file to the PLC, save an XML file from the PLC, or delete an existing XML file on the PLC. The XML configuration files contain the setup settings for your pumping station.

Caution:

Downloading an incorrect XML file to the PLC may render the system inoperable. Ensure you

have the correct file before selecting [Download to PLC].

Tap [Next] to move to the next System Setup screen.

Basic Pump Information

The number of pumps can be selected from a drop down menu. Note that this is set from the factory and changing the number of pumps could render the station inoperable if the selection does not match the actual number of pumps.

The number of zones can also be set from the drop down menu.

Each pump can be assigned a name in the editable fields at the bottom of the screen.

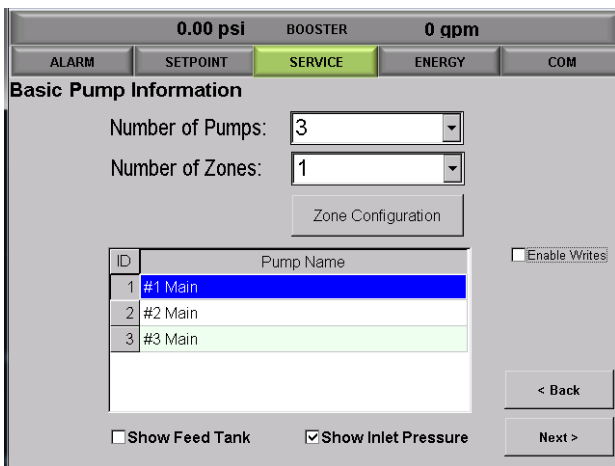

Figure 56: Basic Pump Information

By selecting “Show Inlet Pressure” or “Show Feed Tank”, those valves will be displayed on the Booster Home Screen.

Zone Configuration

Tapping [Zone Configuration] will allow you to configure the zones for the system.

The number of flow zones is adjusted here. Up to 7 zones can be selected. This controls how many flow totalizers are operable. Each flow zone will keep track of water usage by day, week, month and year (5 years).

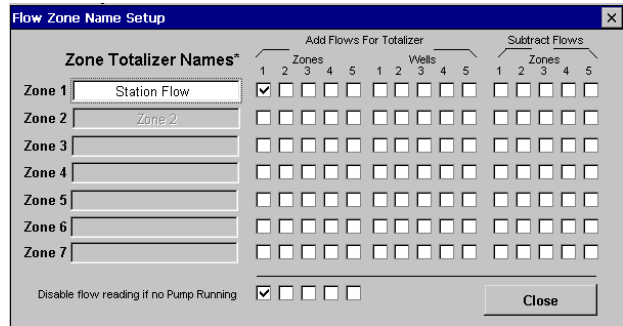

Figure 57: Zone Totalizer Setup

The name of the flow zone is set here. Also, the flow channel that is totalized for each zone is configured here. These channels match the flow channels from calibration. In addition to picking a single channel for a particular zone, multiple channels can be added together to form a single flow zone by selecting more than one “Zone” to totalize. Flow zones can also be subtracted from the total by selecting a “Subtract Flows” channel. This may be required when a meter reads flows going to more than one zone, and one of these subsequent zones is metered separately.

Flow filtering is setup here as well. By selecting “Disable Flow Reading if No Pump Running” for a channel, that flow reading will be zero’d out when no pump is running. This is in case the system picks up fluctuations that cause the meter to generate undesirable small flows when the pumps are not running.

Tap [Close] to save.

Tap [Next] to move to the next screen.

Pump Configuration

This section will allow you to configure the pumps for the system. **Please note that the Booster station is pre-configured at the factory. Any changes could be detrimental to the station.**

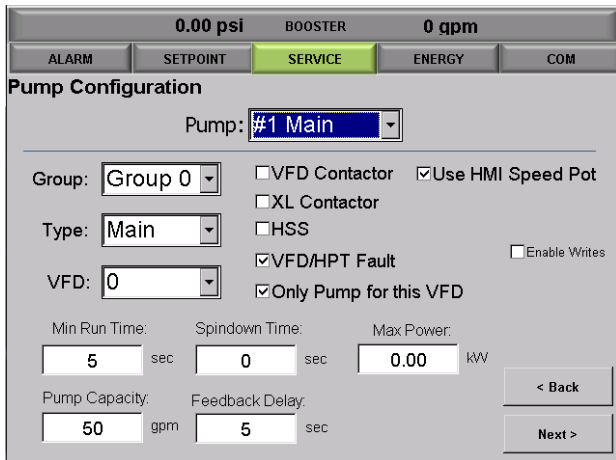

Figure 58: Pump Configuration

Each pump can be selected from a drop down menu in this screen. It can be assigned a group, type (Main, Jockey, or PM), and number of VFDs that are going to be used.

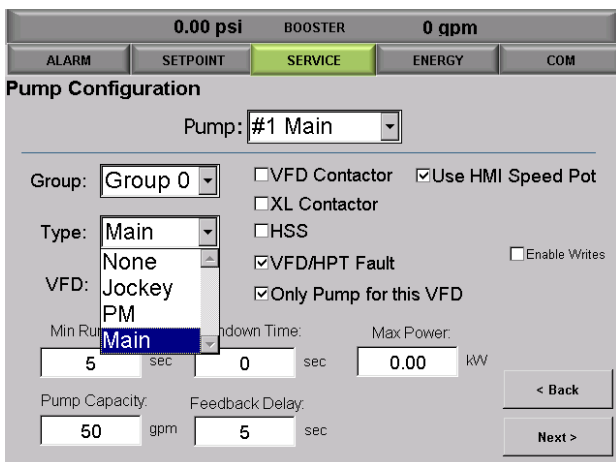

Figure 59: Pump Type Configuration

Selections can be made regarding the pump being a XL, VFD, HPT, HSS, or Only pump for this VFD. For most Booster Stations these selections will be limited to your configured set up. Contact the factory for special configurations.

Enter the minimum run time, Spindown Time, Pump Capacity, Feedback Delay for each pump.

Tap [Next] to move to the next System Setup screen.

Control Options

This section will allow you to configure the control options for the system.

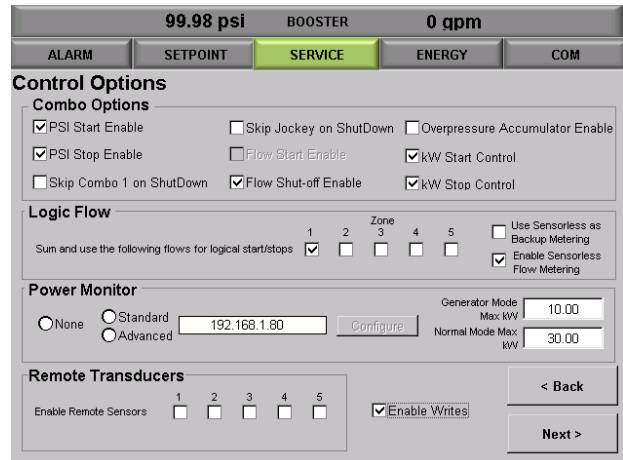

Figure 60: Control Options

Combo Options

This section allows you to make various selections on control options for the station detailed below.

- “PSI Start Enable”
- “PSI Stop Enable”
- “Skip Combo 1 on ShutDown”
- “Skip Jockey on ShutDown”
- “Flow Shot-off Enable”
- “Overpressure Accumulator Enable”
- “kW Start Control”
- “kW Stop Control”

Logic Flow

This section allows the user to enable the Dynamic Flow Loss Compensation Mode. This mode will use built in logic to determine the flow rate of the system and calculate system losses without the need for external mounted flow meters or pressure transmitters.

Power Monitor

This section allow the use to set up the use of an extrnal power monitor.

“None, Standard or Advanced”
These are the options available for power monitoring.

“Generator Mode Max kW”
This is the current allowable “Maximum Power” set for the station in Generator Mode. Generator Mode is a pre-configured factory option that allows for the use of emergency power generators in the event that main power is lost.

“Normal Mode Max kW” is the current allowable “Maximum Power” set for the station in under normal operating conditions.

Remote Transducers

This section will allow you to enable remote transducers that are installed. To adjust the

“Enable Remote Sensors”

These are the options available for power monitoring.

Combo Definitions

This screen allows you to checkmark various combo options. ‘PSI Start Enable’ and ‘PSI stop Enable’ are essential. Without these two, the station will not start stop based on pressure indications. All other checkmarks are need based.

Logic flow enables you to select which zones are used for flow shutoff. The zones are added together to provide the flow to compare to the flow shutoff setpoints.

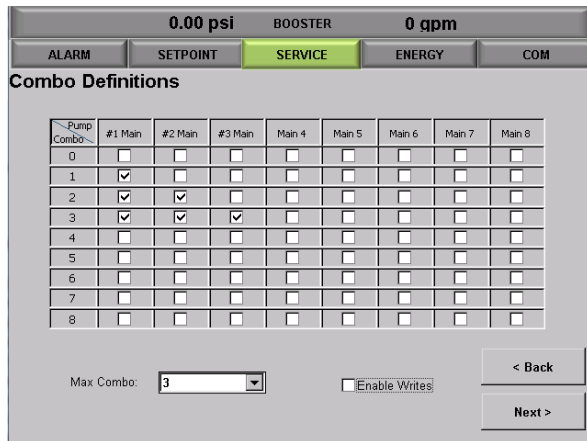

Figure 61: Combo Definitions

8. [Analog Scaling]

Tap [Analog Scaling] from the Options Setup Menu.

This screen allows you to scale raw values into engineering units for analog signal inputs.

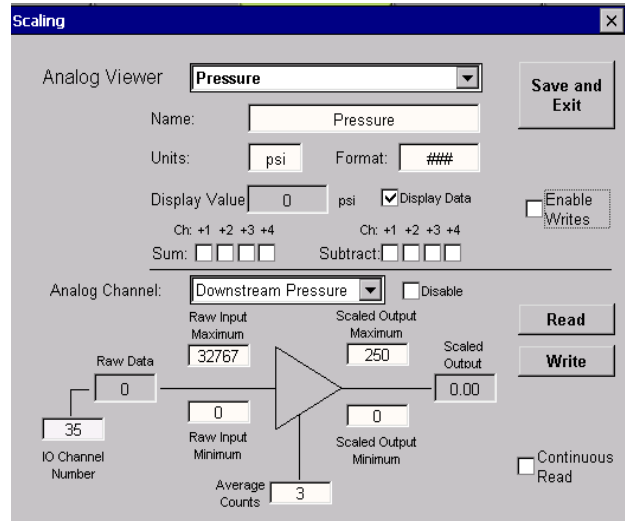

Figure 62: Analog Scaling

For each signal such as Pressure, the analog input values are shown on the left while the scaled output values are shown on the right.

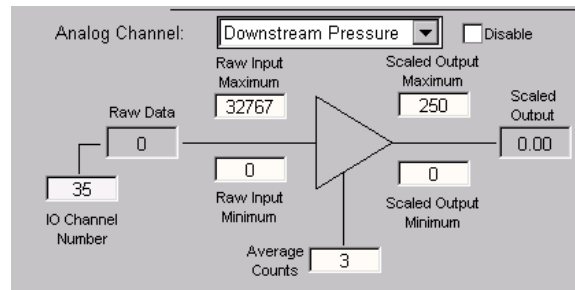

Figure 63: Analog Scaling Detail

Tap “Names” value to change any of the names of the variables displayed (Flow, Pressure, etc.). This can also be used when adding on functionality to the system. There are a few ‘spare’ I/O names available and those can be edited to match the new variable for scaling.

Tap [Close] to return to the Options Setup Menu.

9. [Alarm Configuration]

This screen allows you to select various alarm types from the drop down menu, and fill in the required settings for each alarm.

Default settings (standard factory settings) can be found in Appendix D.

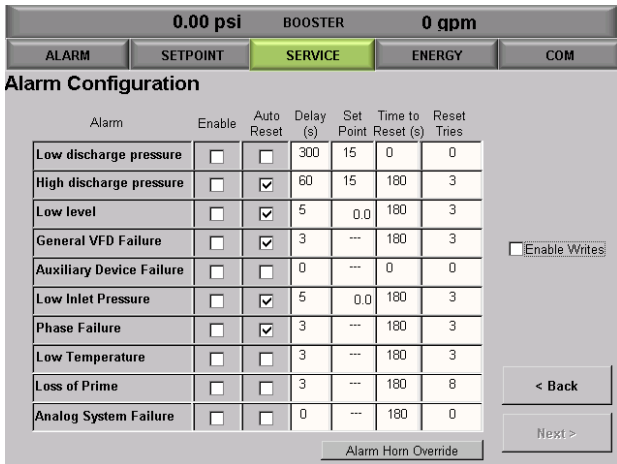

Figure 64: Alarm Configuration

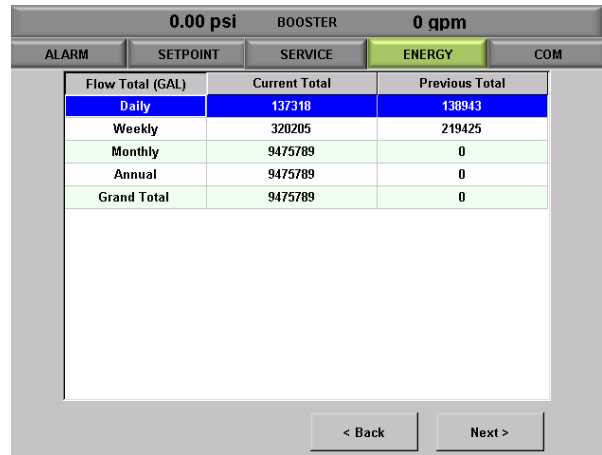

Figure 66: Flow Totals Overview

Tap [Next] to successively view the totals for each day, week, month and year. Use the scroll bar to move up and down or left and right.

ENERGY

The [ENERGY] tab will take you to the Power usage detail screen. From here you will be able to see the totalized values for Flow and KWh in tabular format.

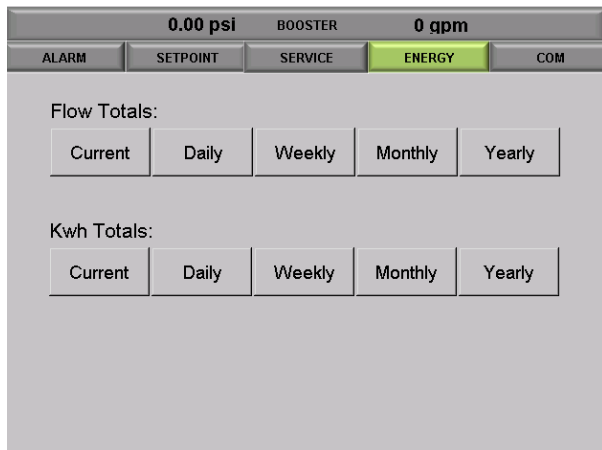

Figure 65: Energy Home Screen

By tapping on the desired box a tabular screen will appear as shown in Figure 66.



Figure 67: Daily Flow Totals Overview

COMMUNICATION

The [COM] tab will take you to the Communications setup screen where you can configure the available communications protocol.

Communications takes place by way of drivers installed on the HMI. Configuration of these drivers is done through the "COM" screen. Due to the nature of the files accessed by this screen, COM configuration cannot be done via web access to the controller.

Only one driver is available at a time. Initially, no drivers are selected. Use the checkbox to select which protocol to use, the press the button next to the checkbox to modify the parameters of the protocol.

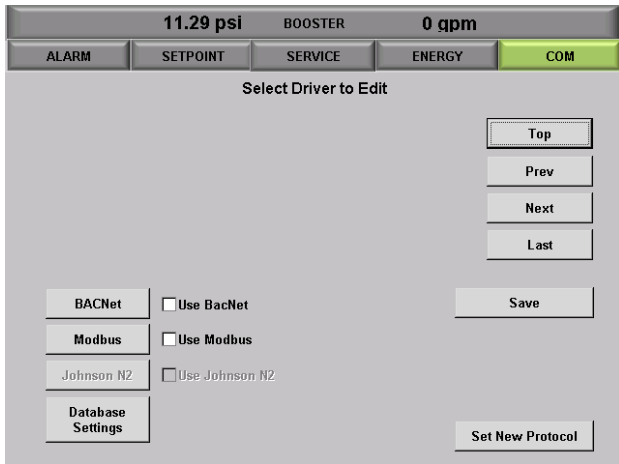

Figure 68: COM Home Screen

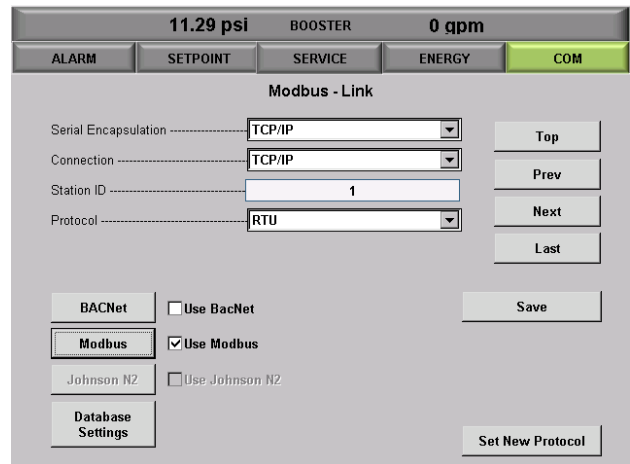

Figure 71: COM Protocol Selection

Protocol settings are then available for editing. Use the Top, Prev, Next and Last buttons to navigate among the pages of the properties for the protocol selected. Press Save for each page as changes are made. Once all the changes are made, press “Set New Protocol”. The HMI will reboot to make the required changes. The station will still operate during this process, but the HMI will not show pressure/flow etc., remote connection will be lost etc. However there will be no loss of pump operation.

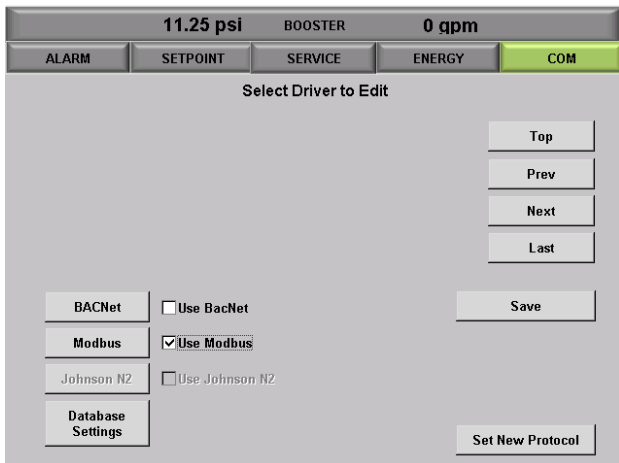

Figure 69: COM Protocol Selection



Figure 70: COM Protocol Selection

Typical settings for Modbus TCP are as follows:

			TimeOut-End	0
			TimeOut-Interval Between Char	500
Page	Modbus - Link		TimeOut-Wait CTS	100
	Serial Encapsulation	TCP/IP		
	Connection	TCP/IP		
	Station ID	1	Page	Modbus - Advanced - C
	Protocol	RTU		Control RTS
				Verify CTS
	Modbus - Modem			Disable DTR
Page	Configuration			Enable IR
		Auto Detect	Table 1: Modbus TCP Settings	
	Modem Identifier	2		
		<As		
	Phone Number	Required >		
Page	Modbus - Modem Options			
	Enable incoming calls	No		
	Auto Connect Enable	Yes		
	Auto Connect Retry Interval (s)	120		
	Disconnect if call idle more than...	1		
	Auto-Disconnect time (s)	120		
Page	Modbus - Com Port			
	Com Port	COM2		
	Baud	9600		
	Data Bits	8		
	Stop Bits	1		
	Parity	None		
Page	Modbus - TCP and UDP			
		192.168.1.1		
	IP Address	5		
	Port #	502		
	Server Mode	Yes		
Page	Modbus - Advanced - A			
	Use Transaction ID	Yes		
	Word Type	Unsigned		
	Protocol-Retries	0		
	TX Buffer	512		
	RX Buffer	512		
Page	Modbus - Advanced - B			
	TimeOut-Start	1000		

Typical BacNet communications settings are as follows:

Page	BacNet - Link	
	Serial Encapsulation	TCP/IP
	Link Type	BacNet IP
	Device UDP Port	47808
	MSTP MAC	
Page	BacNet - Modem Configuration	
	Modem Identifier	Auto Detect 2 <As Required>
Page	BacNet - Modem Options	
	Enable incoming calls	No
	Auto Connect Enable	Yes
	Auto Connect Retry Interval (s)	120
	Disconnect if call idle more than...	1
	Auto-Disconnect time (s)	120
Page	BacNet - Com Port	
	Com Port	COM2
	Baud	9600
	Data Bits	8
	Stop Bits	1
	Parity	None
Page	BacNet - TCP and UDP	
	IP Address	192.168.1.15
	Port #	47808
	Server Mode	Yes
Page	BacNet - Advanced - A	
	Protocol-Station	1
	Protocol-Retries	0
	TX Buffer	512
	RX Buffer	512
Page	BacNet - Advanced - B	
	TimeOut-Start	1000
	TimeOut-End	0
	TimeOut-Interval Between	

Char	500
TimeOut-Wait CTS	100

Page	BacNet - Advanced - C	
	Control RTS	No
	Verify CTS	No
	Disable DTR	No
	Enable IR	No

Table 2: BacNet Settings

Setup/Configuration File

ActiveX and IP Updates

Tap [ActiveX and IP Updates] from the Options Setup Menu.

By default both ISSymbol URL and Agent URL are automatically populated.

View Current Configuration: View the entire URL in a popover screen.

Set Configuration: Set and save new web configurations.

Email: Get notifications via email.

Tap [Close] to return to the Options Setup Menu.

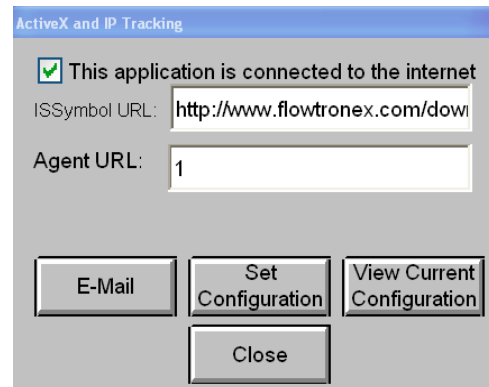

Figure 72: ActiveX and IP Updates

WinCE Remote Access

Tap [WinCE Remote Access] from the Options Setup Menu

This screen allows you to communicate with a remote server using Telnet. This feature is intended for advanced custom jobs.

CAUTION:

Before using this feature or changing any settings on this screen, please call customer service.

Tap [Close] to return to the Options Setup Menu.

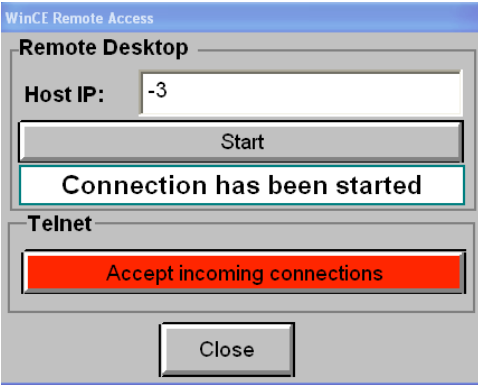

Figure 73: WinCE Remote Access

Networking and Remote Access

The general instructions and screen-shots provided in this manual for operating the HMI may be used when accessing the interface via the internet on a personal computer.

For instructions related to configuring your personal computer, please see appendix G.

Please note that when using a personal computer, the touch-screen functionality is not available. To navigate the screens:

- Click on the buttons with your mouse.
- Use your mouse to click in a blank field. Enter text or numbers using a standard PC keyboard.

Remote Software Log In

An identical version of the HMI software may be accessed remotely by an Internet IP (Internet Protocol) address. Type the following address into an internet browser:

From within your network (at the maintenance facility), open your web browser and type the following URL into the address line: <http://192.168.1.15>. This will take you directly to the HMI's web server.

To access your pump station from outside of your network, you must first determine the IP address of the router as seen from the internet. Note that this can be somewhat difficult to determine without help from your IT department (if you have one). The router IP address can be found through the use of 3rd party IP address resolution sites (available on the internet) or by navigating the router's administration pages.

In the pop up screen, enter your username and password to log in.

After the HMI interface opens, the user type (from Guest to Supervisor) may be changed by the standard procedure described for touch panel log in.

Web Reports

Internet users of the HMI interface can also view and print different reports. There is an Alarms Report, Historical Report, Usage Report, and Factory Reports. The navigation bar allows the user to access each report's setup screen and print the report. The trends screen can also be customized, a feature which is unavailable in the local HMI interface.

Log on to Web Reports

Log on to the reports menu by typing the following in the address bar of your browser:

<http://000.000.000.00/reportmenu.html>

where *000.000.000.00* is replaced by your IP address. Enter your username and password in the log in screen displayed. Click [OK] to submit or [Cancel] to cancel.

You can obtain your IP address through your IT department or internet service provider.

Web Reports Menu

After logging in, web reports menu is displayed containing the following buttons, Login, Trend View, Alarms Report, Historical Report, Usage Report, Factory Report, Print Setup, Print, and Exit.

NOTE: Factory Report is available only to a supervisor or technician. It includes a list of values of various PLC registers and is not covered further in this guide.

The banner at the top shows the current date and time. Using this bar, alarm reports, usage reports (in gallons), and several setup files in .xml format. All reports can be printed. Use [Exit] to exit the reports menu.



Figure 74: Web Reports Menu

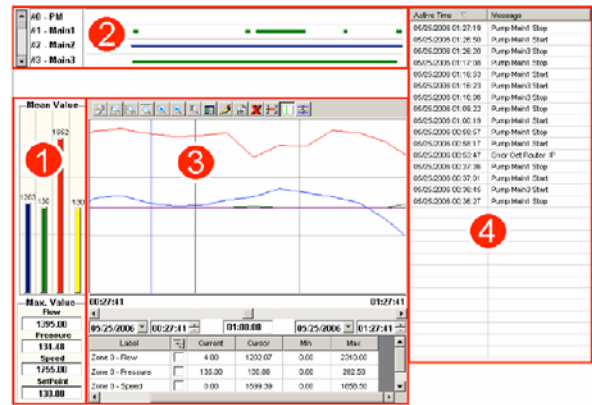

Figure 75: Trends View

Trend View

Select [Trend View] from the Web Reports Menu.

There are four key parts to the trends screen.

1 Mean Value Graph and Detail: For each of the key variables (Flow, Pressure, Speed, and Setpoint) the mean values are displayed as a vertical bar graph on the top while the Maximum values are displayed in fields below. **2 Pump Run Log:** Graphically displays the pump operation for the time frame selected. These are color coded:

- Green - indicates pump is running
- Blue - indicates pump is running on VFD.
- Red - indicates pump is in a fault condition.

3 Variables Graph: Line graph displays color-coded information for key variables over a specified time. The top bar of the graph also has zoom, period, and legend options. The grid below displays variable data. Click [...] to choose line colors. Choose the start date, time and duration for the graph from fields positioned between the graph and grid.

4 Events Listing: Details the time and events for a duration time defined by the user, as for the variables graph.

Alarms Report

Select [Alarms Report] from the Web Reports Menu.

Alarms Report allows you to view the last 10 system alarms and events.

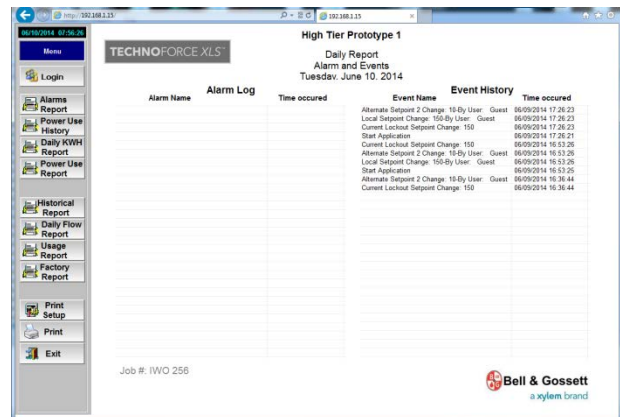

Figure 76: Alarms & Events

All reports can be printed using [Print], after a printer has been set up by clicking on [Print Setup].

Historical Report

Select [Historical Report] from the Web Reports menu.

Historical Report allows you to access the data and bar graph representation of your station's Annual, Monthly, and Weekly Flow information. The actual gallons are shown in the data table on the left, and three bar graphs (annual, monthly, and weekly) on the right.

All reports can be printed using [Print], after a printer has been set up by clicking on [Print Setup].

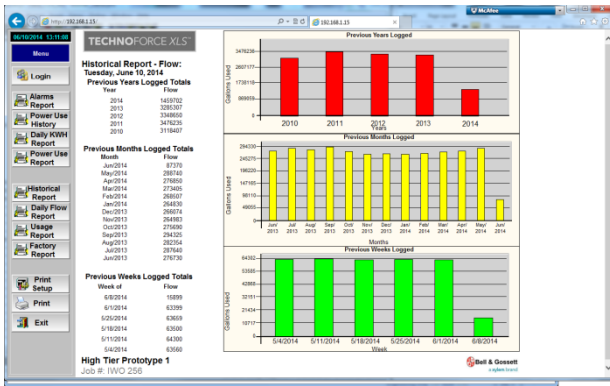

Figure 77: Historical Report

Usage Report

Select [Usage Report] from the Web Reports Menu.

Usage Report allows you to view the totalized flow values for each day, week, month, and year. The table in the middle on the left shows the times or counters when totalizers reset. Table on bottom left shows the number of starts, and runtime hours for each pump.

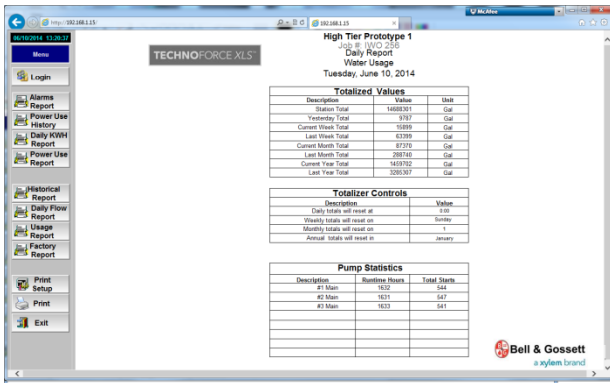

Figure 78: Usage Report

Smart Phone and PDA access:

A simpler web page is available for smart phone access. The IP address of this page is the external address determined in appendix "G", but a specific page address is required to access the simplified page: "<myIPAddress>/sma/logon.asp" where <myIPAddress> is the external IP address. Note that "192.168.1.15" will never be the correct address since the smartphone or PDA is always attempting to access the page from outside your network.

Appendix A–Glossary of Terms

The terms used in this manual are defined in the Glossary of Terms. In addition, other industry specific or product-specific terms are included that may be used by technicians or customer service when talking about your pumping system.

Across-the-line (XL)	Applying 100% of line voltage to a motor during startup and run. A simple large relay with a contact for each power phase (for 3 phase) is used to control the motor OFF/ON.
Analog	A signal that varies in some respect (voltage, current, frequency) in order to convey the value of some real world information (i.e. pressure, flow, temperature etc.). A control system can take action based on the value of such a signal. Internally, the signal will be converted to some number based on the value of the signal.
Automatic lake screen	(ALS) A screen on the intake flume of the pump station, between the irrigation pond and the wet well, which is designed to be self-cleaning by using a jet of clean water spraying from the inside-out during use.
Booster	A pump designed to increase the pressure of a pressurized irrigation line. This is usually used to move pressurized water from a lower to higher elevation area of the golf course.
Calibration	The act of or specific values used to scale the output of a measurement device to read real-world values.
Chemical injection	The process of adding chemicals to irrigation water to fertilize or medicate turf grass.
Combo	A capacity level representing a predefined group of pumps on a station. Normally Combos are defined as follows:
Combo 1	Normally the PM pump.
Combo 2	Lead pump. Normally the VSP.
Combo 3	Lead pump and first lag pump.
Combo 4	Lead pump and two lag pumps.
Control valve	A valve designed to automatically open/close in order to maintain a specific setpoint pressure, flow, or level.
Control variable	A value that a control system monitors in order to perform some useful function.
Cycling	This condition occurs when conditions require a pump to start if no pump is running, but require a pump to stop if a pump is running. This is excessive starting and stopping of one or more pumps and can be damaging to the equipment if allowed to continue.
Equal HP pumps	Also referred to as interchangeable pumps. Defines which pumps are available to start based on lowest run time. VSPs and XL pumps are defined in the PLC program. An XL pump can be an equal HP pump, but it will not start as a lead pump, because the lead pump will always be a VSP.

Filter	A device used downstream of the pumps to clean the water being pumped into the irrigation. These devices are typically self-cleaning, but require hardware/software to self-clean.
Fixed speed	Pumps run at a fixed RPM, defined by the motor windings and the frequency of the line voltage (50/60 Hz).
Frequency	(Hz) The number of oscillations per second of any system. Typically used to refer to electrical systems, such as AC power line frequency, or variable speed drive output frequency. This frequency defines the speed of an AC motor.
GPM	Gallons per minute. Units of flow for US use.
HSS	High speed switching. Starting pumps with a VFD to reduce inrush current and provide pressure control, but able to switch over to fixed speed so that the VFD is able to start another pump.
Input	A way for a control system to detect real-world occurrences. These can be digital or analog.
Inverter	Another term for Variable Frequency Drive (VFD). Actually, more correctly applied to the output circuitry of the drive, which converts DC voltage to AC voltage.
Lag pump	A pump used later in the pump sequence to support increasing irrigation demand requirements. The term lag simply refers to the fact that it does not start first.
Lake fill	(LLC) A circuit designed to keep a pond or lake at or above some minimum level of water.
Lead pump	The pump in a lead group which is chosen by the controller to start first. This is usually determined by finding the pump in the lead group with the lowest run-time.
Lockout	A system which limits the pump systems available pumps and or limits the speed of a variable speed pump during user-defined time of day or day of week.
Low level probe	A device that "shorts" out when removed from water. This removes the signal from the PLC and tells it that the pump is not safe to run due to a low water level condition.
Main pumps	The pumps which are relied on for supplying the irrigation at mid-high flow rates.
Must-run time	The amount of time (in seconds) that the pump must run.
Output	A way for a control system to generate real world actions. An output can be a 120VAC signal to turn on a pump, or a varying 4-20 mA signal to control the speed of a VFD. Many types of output are available.
Overload	A condition in which pumps are allowed to produce more flow rate than the motor that drives them is designed for. Also refers to a device in the control panel, which detects this situation and stops the pump in order to protect it.
Overpressure accumulator	A counter that is used to determine the lag pump shut down sequence.

Phase monitor	A device that analyzes incoming voltage and determines whether all voltage parameters are acceptable and the phase sequence is correct.
PLC	Programmable Logic Controller. A very robust/rugged computer designed for equipment control in harsh environments.
PM pump	Pressure Maintenance Pump. Handles very light flow rates and leaks to prevent the main pumps from cycling.
Pressure reducing valve	(PRV) A control valve designed strictly for maintaining a specific downstream pressure.
Pressure transducer	A device that converts actual pressure to a 4-20 mA signal that is input into the PLC which converts it back to an actual pressure reading.
PSI	Pounds per square inch. Units of pressure for US use.
Relay	This is a normally open or normally closed device that changes output state when it is energized or de-energized and sends or removes a 120VAC signal to the PLC.
SCADA	Supervisory Control And Data Acquisition.
Setpoint	The desired situation for a control variable. If the user wanted the irrigation system to operate at 120 PSI, that would be the setpoint for the controller.
Speed test	The method used to shut down a VSP during normal automatic operation.
Transfer pump	A pump designed to move water from one reservoir to another.
Units	Gives context to numbers in the PLC. Units describe what the number is about, such as PSI, GPM.
VFD	Variable frequency drive. This allows a pump to run at variable speeds.

Appendix B – Networking Options

Typical Network Diagram

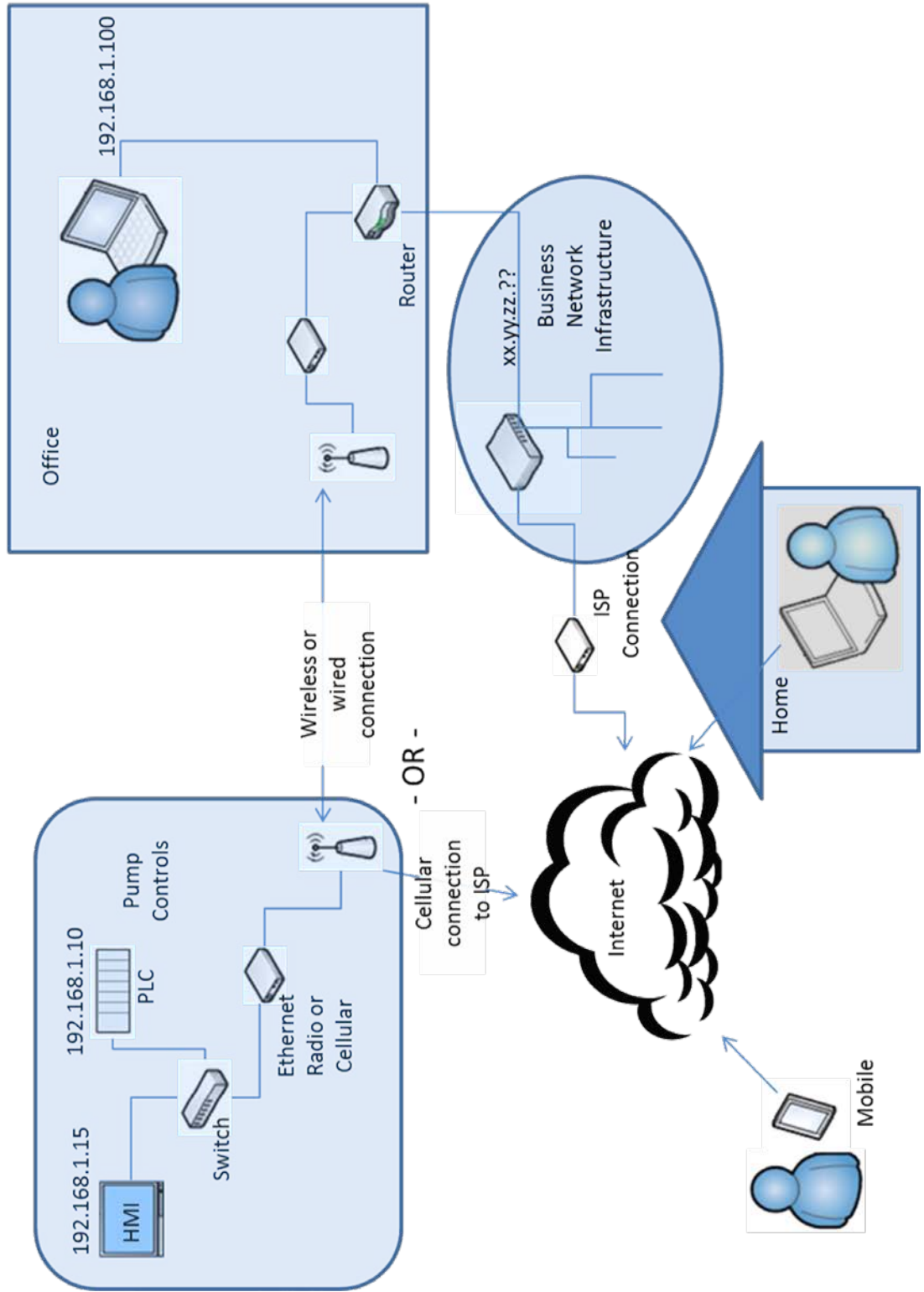

Appendix C–Typical Alarms Configuration

Alarm / Fault Name	Auto Reset Available	No. Reset Attempts	Type of Alarm	Alarm Delay (SEC)	Alarm SP (PSI)	Delay Time (SEC)
Low Discharge Pressure	No Auto Reset	N/A	Required	300	25	N/A
High Discharge Pressure	Auto Reset Allowed	3	Required	60	15	60
Low Level (in well or transfer pumps).	Auto Reset Allowed	3	Required	5	N/A	60
VFD Failure	Auto Reset Allowed	3	Required	2	N/A	60
Aux(iliary) Device Failure	Auto Reset Allowed	3	Optional	Var.dep. on type	N/A	60
Low Inlet Pressure	Auto Reset Allowed	3	Optional	20	N/A	60
Phase Failure	Auto Reset Allowed	3	Required	1	N/A	60
Low-Temperature Fault	Auto Reset Allowed	3	Optional	20	N/A	60
Loss of Prime	Auto Reset Allowed	3	Optional	20	N/A	60
Analog System Failure	Auto Reset Allowed	3	Optional	20	N/A	60

Default Alarms / Faults

Appendix D – Email Troubleshooting

DETERMINING THE IP ADDRESS OF THE SMTP SERVER

On your Windows PC, Click “Start”, “Run”, type in “CMD” in the dialog and press enter.

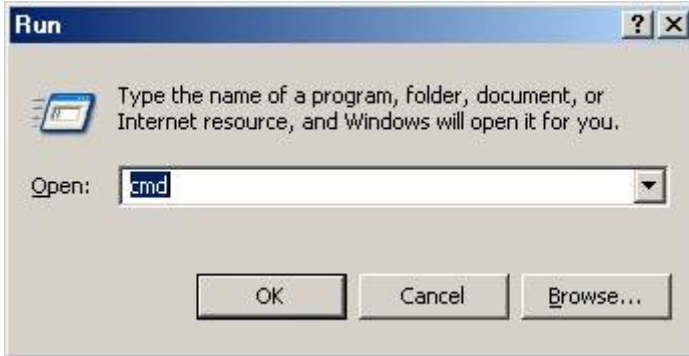

You will see a DOS prompt window similar to that below.

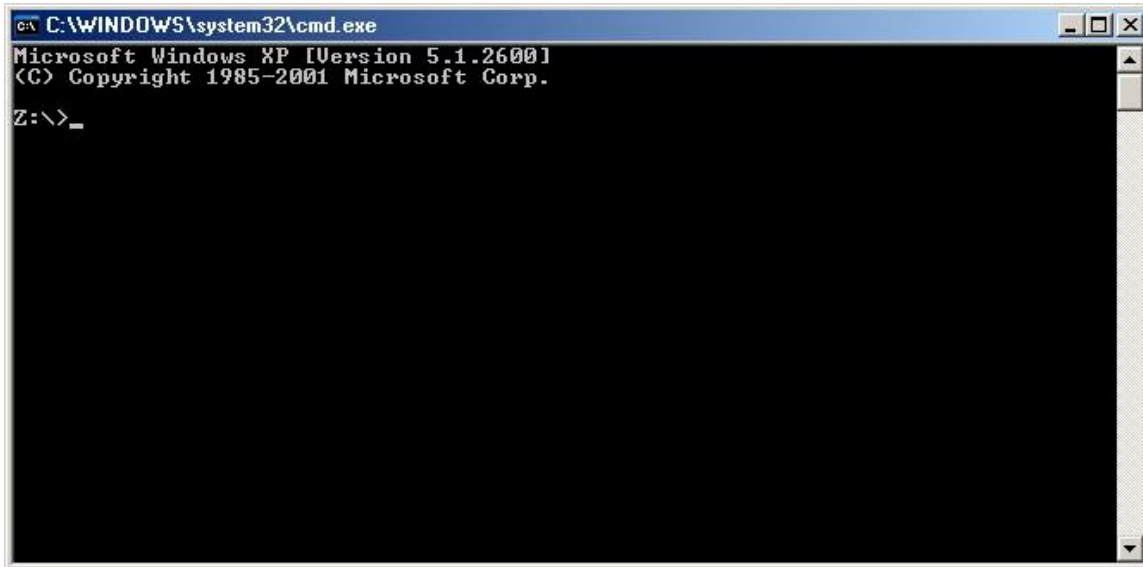

Type “ping” followed by the server name of your SMTP service. Your email provider will be able to supply these server names as a standard part of the information needed to set up your email for outlook or other email programs.

```
ca C:\WINDOWS\system32\cmd.exe
Microsoft Windows XP [Version 5.1.2600]
(C) Copyright 1985-2001 Microsoft Corp.

Z:\>ping smtp.runbox.com

Pinging smtp.runbox.com [87.238.52.70] with 32 bytes of data:

Reply from 87.238.52.70: bytes=32 time=181ms TTL=43
Request timed out.
Reply from 87.238.52.70: bytes=32 time=194ms TTL=43
Reply from 87.238.52.70: bytes=32 time=199ms TTL=43

Ping statistics for 87.238.52.70:
    Packets: Sent = 4, Received = 3, Lost = 1 (25% loss),
    Approximate round trip times in milli-seconds:
        Minimum = 181ms, Maximum = 199ms, Average = 191ms

Z:\>
```

Look at the line following your command entry, this will contain the IP address of the SMTP server. In this case, smtp.runbox.com is at IP address 87.238.52.70.

```
ca C:\WINDOWS\system32\cmd.exe
Microsoft Windows XP [Version 5.1.2600]
(C) Copyright 1985-2001 Microsoft Corp.

Z:\>ping pop.runbox.com

Pinging aibo.runbox.com [87.238.52.70] with 32 bytes of data:

Reply from 87.238.52.70: bytes=32 time=181ms TTL=43
Reply from 87.238.52.70: bytes=32 time=180ms TTL=43
Reply from 87.238.52.70: bytes=32 time=184ms TTL=43
Reply from 87.238.52.70: bytes=32 time=182ms TTL=43

Ping statistics for 87.238.52.70:
    Packets: Sent = 4, Received = 4, Lost = 0 (0% loss),
    Approximate round trip times in milli-seconds:
        Minimum = 180ms, Maximum = 184ms, Average = 181ms

Z:\>
```

Double-check the POP3 server for the same IP address. Same procedure, but use your pop3 server name in the ping statement.

TROUBLESHOOTING GENERAL EMAIL FAILURES

The following are some common problems encountered when configuring email settings. Double check each setting to ensure the correct information was entered.

1. Attempting to use the server name rather than the IP address in the SMTP field.
2. Using an incorrect IP address - determine the IP address from the procedure above.
3. Entering an invalid user. Make sure the user field matches the account. Also make sure the "From" field matches the user information exactly.
4. Inputting an incorrect password.
5. The mail service does not support SMTP
6. Your internet service provider does not allow access out of your network on TCP/IP port 25.

Troubleshooting Email SET Failures

The following table gives the number codes associated with failures received after tapping [SET] to set the SMTP:

0	Success
1	Invalid format for strSMTP
2	Invalid format for strFrom
3	Invalid format for strPOP3
4	Invalid format for strUser
5	Invalid format for strPassword
6	Invalid format for optNumTimeout
7	Wrong number of parameters
8	Error getting host IP address (invalid POP3 server)
9	Error connecting to POP3 server
10	Error sending username
11	Error sending password
12	SMTP server does not support selected authentication mode
13	Invalid SMTP username
14	Authentication failed

SMTP error Codes, Set SMTP Function

Troubleshooting Email Send Failures

The following table gives the number codes associated with failures received after tapping [SEND] to do a test-run of the email addresses and the SMTP:

Value	Description
0	Success
1	Invalid format for parameter 1 (Subject)
2	Invalid format for parameter 2 (Message)
3	Invalid format for parameter 3 (To)
4	Wrong number of parameters
5	Start Socket error
6	Error getting host IP Address (i.e. invalid SMTP server)
7	Error connecting to SMTP server
8	Error sending HELO command (initialization)
9	Error sending MAIL command (sending FROM address)
10	Error sending RCPT command (sending TO address)
11	Error sending DATA (sending message)

SMTP Error Codes, Test Email Function

The following test can be used to check for access to the SMTP server:

- Open a command window as in checking for the IP address above.
- Use Telnet to attempt to connect to smtp.runbox.com on port 25 (or your email servers name)

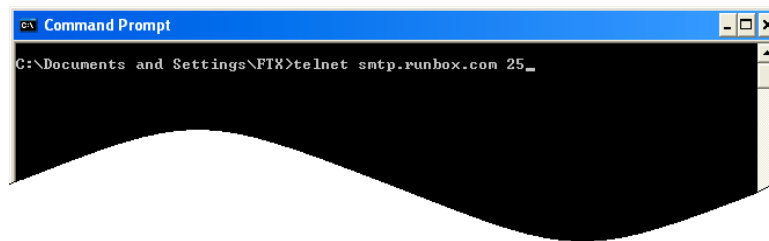

```
Command Prompt
C:\Documents and Settings\FTX>telnet smtp.runbox.com 25_
```

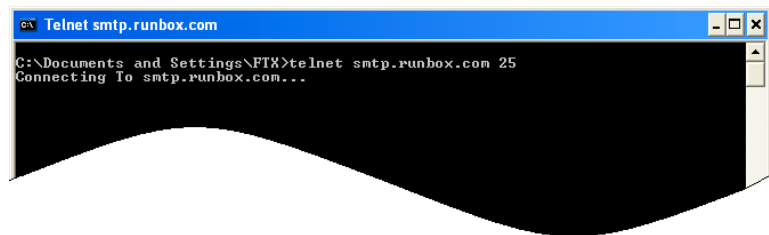

```
Telnet smtp.runbox.com
C:\Documents and Settings\FTX>telnet smtp.runbox.com 25
Connecting To smtp.runbox.com...
```

```
ex Telnet smtp.runbox.com
220 penny.runbox.com ESMTP Exim 4.71 Tue, 15 Feb 2011 22:28:11 +0100
_
```

- If successful, be sure and type “quit” <enter>. It’s bad form to leave the server hanging though it will reset the session itself.

```
ex Command Prompt
220 penny.runbox.com ESMTP Exim 4.71 Tue, 15 Feb 2011 22:29:16 +0100
quit
221 penny.runbox.com closing connection

Connection to host lost.
C:\Documents and Settings\FTX>
```

- If you are unable to connect, attempt to Telnet to the POP3 server on port 110.

```
ex Telnet pop3.runbox.com
C:\Documents and Settings\FTX>telnet pop3.runbox.com 110
Connecting To pop3.runbox.com...
```

```
ex Command Prompt
+OK POP3 Ready patch 0002021c
quit
+OK QUIT

Connection to host lost.
C:\Documents and Settings\FTX>
```

Successful Telnet to the POP3 server but unsuccessful telnet to the smtp server is typical of a port 25 block by the ISP. They often block port 25 to prevent spammers from using home and unwary business accounts for spam generation. A call to your ISP will usually resolve the problem quickly. You may have to ask for advanced technical service as this scenario isn't on the standard script for call-center type service.

Appendix E: Computer Setup and Determining the IP address of your pump station

Connecting to the pump station after the hardware is installed is relatively easy. The first step is to connect your PC to the network. This simply means your PC will be connected to the LAN side of the router supplied by Bell & Gossett. Step 2 is to set the IP address of your PC.

Click Local Area Connection.

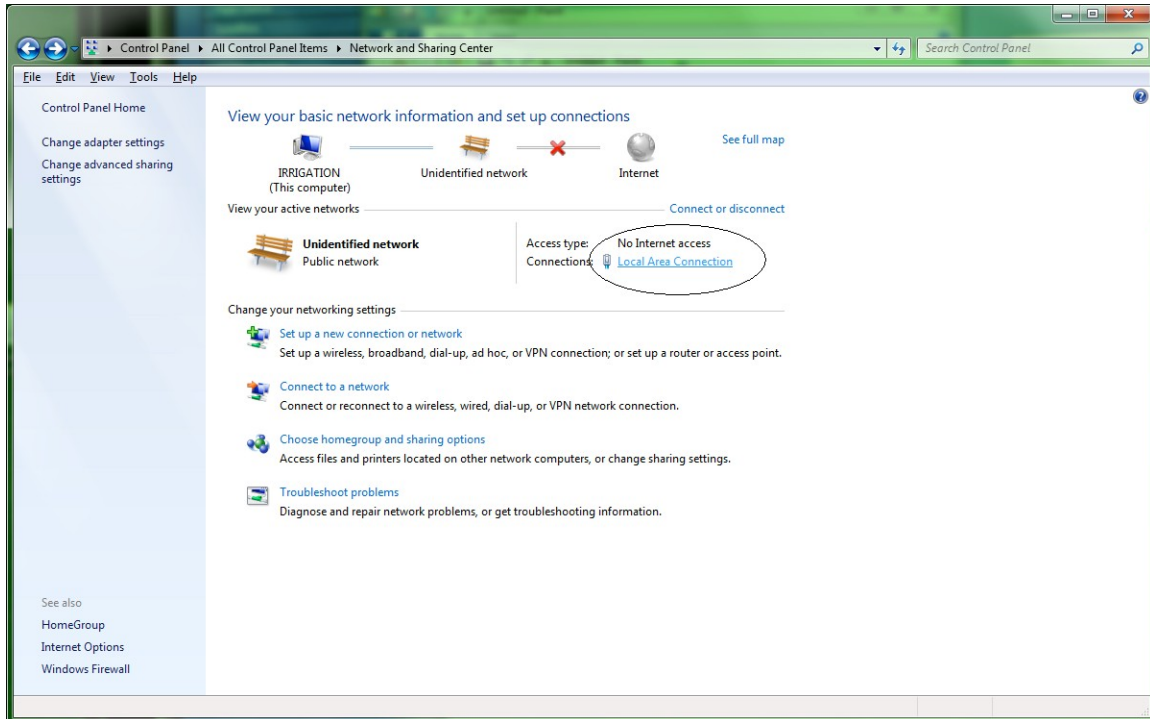

Computer Setup Options

Another window will come up. Select Properties:

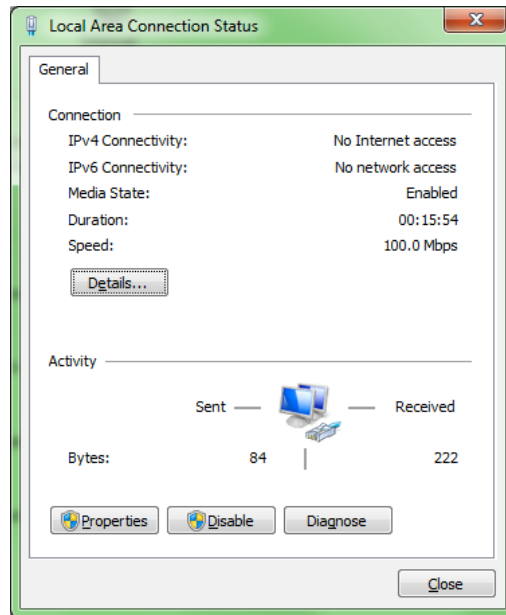

Highlight Internet Protocol (TCP/IP). If there are two entries, one for v6 and one for v4, select v4 as shown. Then select Properties.

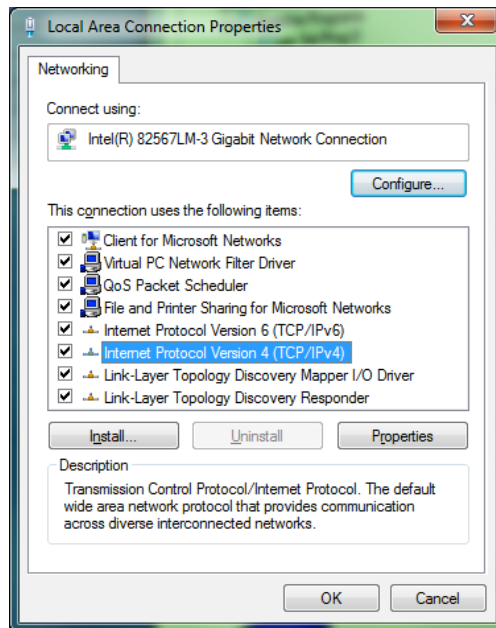

Select "Use the following IP address"

Check with your IT department or internet service provider for proper DNS server settings. These should be no different than your settings before installing the router.

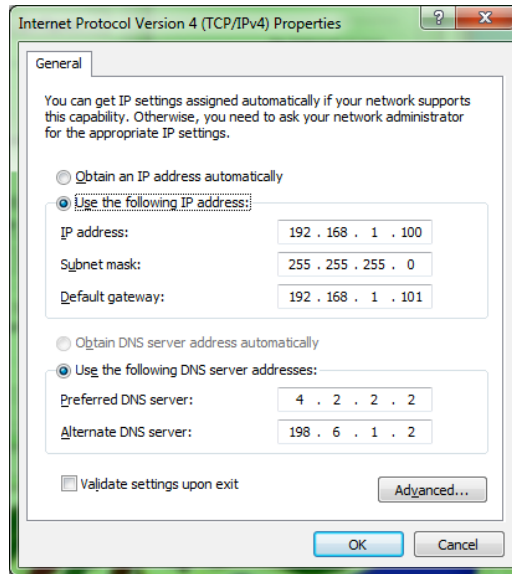

DETERMINING THE IP ADDRESS:

Determining the IP address to use to communicate with your pump station remotely can be as easy as asking your IT professional, or somewhat more complicated, requiring you to access your routers status page. Chances are if you have an IT department, they will have to be involved in setting up your router and should be able to provide you with an IP address. They will need to provide a path for port 80 to the router provided by Bell & Gossett. This router is already set up to port forward the request to the pump station.

If you are connected directly to the internet through a cable or DSL modem, you can find your IP address by accessing the routers status page. With the Ethernet cable connected between your PC and the router, open your internet browser and type in the address, <http://192.168.1.1>. The login page for the router should appear. Use the user name "admin", the password has been left blank, simply click "Log in".

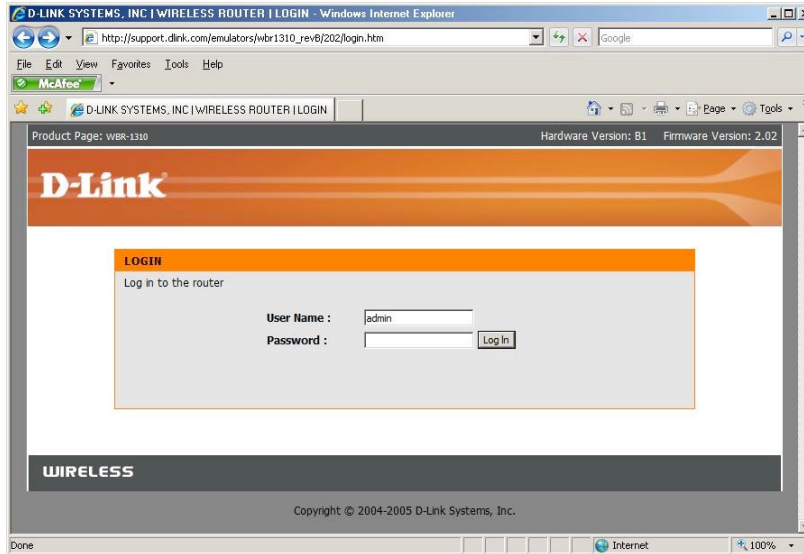

Select the “Status” page from the menu at the top of the screen. Scroll down the page to the “WAN” status to see the IP address assigned by your Internet service provider.

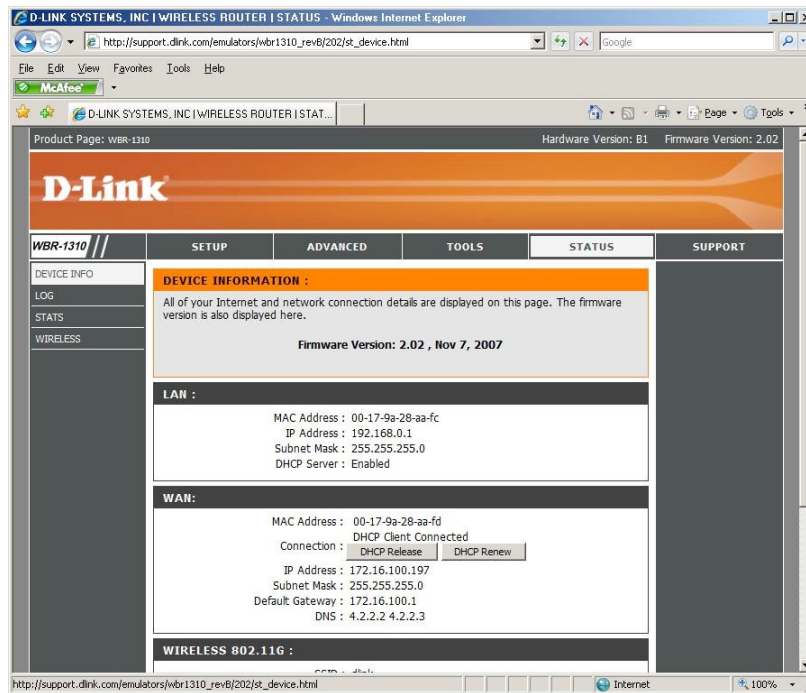

Please note, if your network is more complicated than a simple connection through a cable or DSL modem, please consult your IT department. The procedure outlined above can only supply the IP address of the router, and therefore the IP address of your PC, with reference to the network the router is connected to. If additional routers separate your PC from the outside network, your IT department will need to provide the correct IP address, and open ports to allow you access to your pump station information. If this becomes problematic, it is still possible to use the PC access services used for servicing your irrigation control computer to access your pump station information. In most cases, your pump station can still send email out of the network as required.

Appendix F – General Networking and Router Configuration Discussion:

Regarding the requirement for a fixed IP address: This is not a requirement of the Bell & Gossett control system. This is required so the user attempting to access the system remotely can find the machine on the internet. Without a fixed IP address, the computer is at one of 4,228,250,625 theoretically possible addresses, though usually addresses are assigned within a specific range of a few thousand. The internet service provider typically assigned an IP address dynamically when the computer connects. The dynamic IP address won't affect messaging out, only accessing the station from the outside in. There are for-pay services for keeping track of your IP address via domain name, though these also come at a cost.

There are also often complications related to getting access to the router through any on-site networks. There tend to be one or two routers between the pump station router and "the internet", and each of those routers has to "pass through" or "forward" messages to the pump station router. This is a configuration issue for the routers in the chain and while not a complicated setup, communicating with and getting approval from local IT departments can be difficult.

On most systems, we have a single pump station the user needs to connect to remotely. If port 80 messages can be sent to our router, the user can access his pump station. For example: Let's say their router is set up to pass requests to it (say it's 76.199.123.234) directly to the pump station router. The user types in: <http://76.199.123.234>

Their router forwards the message: <http://192.168.1.1:80> along with the request data. The pump station router passes through port 80 traffic to 192.168.1.15 on port 80. The HMI responds with a web connection. Anything that comes in to their router requesting data from port 80, gets "routed" to the pump station router on port 80, and the pump station router routes it to the HMI.

In another example, the IT router already passes traffic to another web server on port 80, so we can't use port 80. To work around this problem, IT can set their router up to pass port 81 traffic to us on port 80. We still route port 80 traffic to the HMI on port 80 at 192.168.1.15. Again, the web page on the HMI works, though the user will need to access the page by typing in: <http://76.199.123.234:81> (The IP addresses used in these examples are fictitious, except for the "pump station router" which has its LAN side IP address set to 192.168.1.1, and all equipment on the LAN side of the router is in the 192.168.1.X range.

If there are two or more HMIs on site, the site router would have to pass multiple ports to our router, normally 80,81,82,83. We would then route port 80 traffic to 192.168.1.15, 81 to 192.168.1.16, 82 to 192.168.1.17, etc. They would just have to set their routing table up to give us all messages for port 80 to us at port 80, all messages for port 81 to us at port 81, etc. This idea can cascade to several routers. Also, in order for Bell & Gossett to remotely configure the router, port 8080 is used, but no routing is provided in the pump station router since the router itself provides the service (the router user name and password are labeled on the back of the router).

	Router 1	Router 2	Pump Station Router
WAN	76.199.50.60	10.92.168.10	192.168.0.12
LAN	10.92.168.1	192.168.0.1	192.168.1.1
Port Forwarding	80->10.92.168.10:80	80->192.168.0.12:80	80->192.168.1.15:80
	8080->10.92.168.10:8080	8080->192.168.0.12:8080	None (Router Configuration)

The user would access his station by requesting a web page at <http://76.199.50.60> (default port is 80 for HTTP). Note how the pump station router, the last in the line, redirects the port requests to specific device (IP address) at the same port (80). All other routers are just passing along the message, keeping the port #s essentially intact. That doesn't have to be the case though, due to requirements of the IT department, or because some web server may be located at some level in the network, the network may have to look like this:

	Router 1	Router 2	Pump Station Router
WAN	76.199.50.60	10.92.168.10	192.168.0.12
LAN	10.92.168.1	192.168.0.1	192.168.1.1
Port Forwarding	2000->10.92.168.10:2000	2000->192.168.0.12:80	80->192.168.1.15:80
	2010->10.92.168.10:2010	2010->192.168.0.12:8080	None (Router Configuration)

The user would access his station by requesting a web page at <http://76.199.50.60:2000> (The ":2000" specifies the browser to request the data at port 2000 rather than the default port 80). Note that the port # gets reset to 80 before the call to our router. In this case, no change of the pump station router settings would be required. But we could, as follows.

	Router 1	Router 2	Pump Station Router
WAN	76.199.50.60	10.92.168.10	192.168.0.12
LAN	10.92.168.1	192.168.0.1	192.168.1.1
Port Forwarding	2000->10.92.168.10:2000	2000->192.168.0.12:2000	2000->192.168.1.15:80
	2010->10.92.168.10:2010	2010->192.168.0.12:8080	None (Router Configuration)

When multiple pump stations are on the site, more than one port will need to be opened to be able to access all of the stations, either simultaneously or one at a time. Bell & Gossett sets up each HMI in a range. The first HMI is at IP address 192.168.1.15. The second is at 192.168.1.16. The third is at 192.168.1.17, and so on. In the previous example, now with three HMIs to access:

	Router 1	Router 2	Pump Station Router
WAN	76.199.50.60	10.92.168.10	192.168.0.12
LAN	10.92.168.1	192.168.0.1	192.168.1.1
Port Forwarding	2000->10.92.168.10:2000	2000->192.168.0.12:2000	2000->192.168.1.15:80
	2001->10.92.168.10:2001	2001->192.168.0.12:2001	2001->192.168.1.16:80
	2002->10.92.168.10:2002	2002->192.168.0.12:2002	2002->192.168.1.17:80
	2010->10.92.168.10:2010	2010->192.168.0.12:8080	None (Router Configuration)

The user would access Station 1 by requesting a web page at <http://76.199.50.60:2000>, Station 2 is located at <http://76.199.50.60:2001>, Station 3 is located at <http://76.199.50.60:2002>.

Generally, the WAN port of the pump station router is connected directly to the cable or DSL modem, so the complex routing configuration is not required. The pump station router is usually configured as follows:

Pump Station Router	
WAN	76.199.50.60 (Supplied by internet service provider)
LAN	192.168.1.1
Port Forwarding	80->192.168.1.15:80
	81->192.168.1.16:80
	82->192.168.1.17:80

Bell & Gossett is also capable of accessing the HMI and PLC in the pump station for diagnostic and programming purposes, with the aid of personnel onsite. This requires access to additional ports in the same way. Normally Bell & Gossett disables these ports in the pump station router to provide extra security, but can enable and disable this port forwarding for service. To support this capability, the IT department would need to provide a pathway into our router. Bell & Gossett will map the final port forwarding in the pump station router as required, so all the IT department would need to do is map through two unused ports to our router. The first example above is recreated below as an example.

	Router 1	Router 2	Pump Station Router
WAN	76.199.50.60	10.92.168.10	192.168.0.12
LAN	10.92.168.1	192.168.0.1	192.168.1.1
Port Forwarding	80->10.92.168.10:80	80->192.168.0.12:80	80->192.168.1.15:80
	8080->10.92.168.10:8080	8080->192.168.0.12:8080	None (Router Configuration)
	9000->10.92.168.10:9000	9000->192.168.0.12:9000	Programming: Not routed until needed
	9001->10.92.168.10:9000	9001->192.168.0.12:9001	Programming: Not routed until needed

Bell & Gossett will access the router configuration and port-forward as needed for the specific case, then after programming is complete, disable the port forwarding for security.



One problem encountered occasionally is having the same IP address range on BOTH sides of a router. That confuses the router. The Bell & Gossett pump station routers LAN side is set up at 192.168.1.x with a subnet mask of 255.255.255.0. That means all addresses 192.168.1.x are assumed to be inside the network. If the router's WAN side is assigned the address of 192.168.1.129, this will cause problems because the pump station router doesn't know where its LAN side ends (address wise) and where it begins. In that case, the pump station router will have to be configured with a subnet mask to 15 and restrict our internal addresses to use only the lower 4 bits for addressing. That could be a problem if there are devices on the network addressed higher than 192.168.1.15 (i.e. auxiliary equipment, power monitors, etc.). In such cases, it may be required that we set the IP addresses in the equipment to another domain altogether (192.168.200.x for example). This is a non-trivial operation.

Appendix G – Quick Start Guide

This guide will provide a Technician the steps needed to start the Technoforce XLS station. Prior to following this guide the station **must** be mechanically and electrically installed and the system filled with water. All remote sensors, if applicable, should also be installed and calibrated. Please refer to the Station Installation Document and Technician's IOM for detailed set up for the station.

Access

This is for operation at the Technician level. To log in follow the steps below:

1. On the controller touch screen tap the SERVICE key
2. From this menu tap the [Log on/off key], this is at the bottom right corner of the screen.
3. Tap [Technician] and enter the password provided at the time of purchase. Tap  to log in, or  to exit without logging in.
4. Tap [OK]
5. Tap the BOOSTER key located at the very top of the screen to return to the main display.

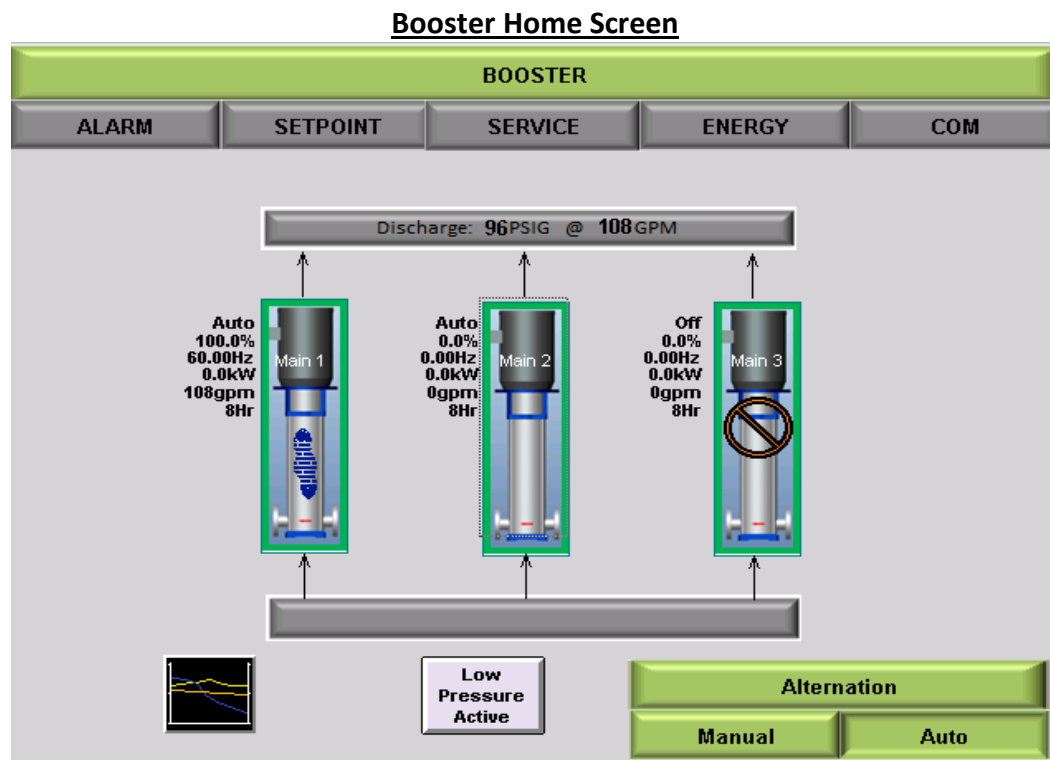

Unit Set-up

Prior to starting the Booster you will need to ensure all of your set points are correct. Please note that the Booster station is pre-configured at the factory based on the work order (WO) which is included in your station documentation.

1. Prior to starting your station verify that this information is accurate.
2. On the controller touch screen tap the SERVICE key.
3. From this menu tap [System Setup]
4. Using [Next], scroll through all of the menus and verify all settings match the station WO. Refer to the Technician's IOM for detailed instructions for each menu screen if changes are required.
5. When you reach the last menu press the BOOSTER key located at the very top of the screen to return to the main display.
6. Tap the SETPOINT key:

The screenshot displays the 'SETPOINT' configuration screen for a booster station. At the top, the current status is shown as '0.00 psi BOOSTER 207 gpm'. The screen is divided into several sections:

- Navigation:** Buttons for ALARM, SETPOINT (highlighted), SERVICE, ENERGY, and COM.
- Current Running Setpoint:** A text box showing '0 psi' and an 'Enable Writes' checkbox.
- Normal Setpoint:** A text box showing '100 psi' with 'Use AI' and 'Lockout Setpoint: 100 psi' options.
- Alternate SP 1 (I/O):** A text box showing '0 psi' with 'Use AI' and 'Input' options.
- Alternate SP 2 (I/O):** A text box showing '0 psi' with 'Use AI' and 'Input' options.
- Relay Output on Flow:** A text box showing '0 gpm'.
- Generator Mode Max Power:** A text box showing '10.0 kW'.
- Remote Transducers:** A section with 'Enable' checked, listing five transducers with their 'Setpoint' and 'Current' values. Remote Transducer #1 is set to 60 psi and shows a current of 62.5 psi.
- Max Local Setpt:** A text box showing '110 % of Current'.
- Up-Ramp Time:** A text box showing '5000 mS'.
- Down-Ramp Time:** A text box showing '5000 mS'.
- APS:** A section for APS configuration including 'Psi Drop' (0 psi below setpt @ zero Flow), 'Flow Calc Pacing Time' (10 sec/sample (20 samples)), and 'APS Setpoint Calculations'.
- APS Setpoint Calculations:** A graph showing 'Running Setpoint' vs 'APS Flow'. The curve starts at 'Zero-Flow Setpt 0' and rises to '100' at '150-Max GPM'. Parameters include 'APS Setpt 100', 'Max Combo=3', and '150 APS Flow'.

7. From this screen ensure that your "Nominal Setpoint" matches the station work order. If not tap in the box and adjust accordingly.
8. If you are using "Alternate SPs" please refer to the Technician's IOM for proper Adjustment.
9. If Remote Transducers have been enabled from the System Set-up screen you can set those setpoints now. Refer to Technician's IOM for detailed set-up. Installation and calibration of the remote transducers should be complete prior to using this configuration.

10. The Dynamic Flow Loss Compensation will be set to zero unless specified on the WO. This setting may need to be adjusted while tuning the station.
11. Press the BOOSTER key located at the very top of the screen to return to the main display.

ATTENTION: The following steps are going to start the station

Unit Start-up



1. From the Booster home screen tap  for pump 1. An enhanced screen will appear that will allow you to place the pump in Auto Mode.

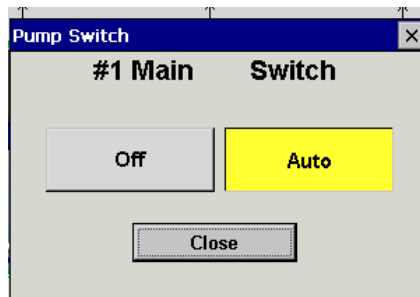

2. Tap [Auto] and the [Close]
3. You should now have Pump 1 set to Auto and the remaining pumps are still off.
4. To start the station, tap [Auto] from the Booster Home Screen.
5. Your station should now have Pump 1 running in Auto Mode.
 - a. Upon start up the pump should ramp up to minimum speed.
 - b. Once minimum speed is reached the pump should step Pump 1 speed up slowly to attain setpoint over a given time period (minimum fill speed).
 - c. IF the station is acting erratically tap [Auto] immediately to turn the station off and review the configuration for proper set up.
 - d. Depending on the demand, the pump could either:
 - i. Meet setpoint and run at a steady state.
 - ii. Ramp down until it turns off.
 - iii. Demand exceeds pump capability and will require another pump to start. At this point Technician should ensure station configuration requires multiple pumps to meet demand before turn on remaining pumps.
6. If station is running with no issues, from the Booster Home Screen place the remaining pumps in Auto Mode.
7. Ensure that the station is functioning properly with all pumps in Auto.
8. Station should meet demand and stage down as the demand on the station is reduced.

9. Ensure that when setpoint is reached and demand is zero, the station will shut down. If not, please review configuration and Technician's IOM for more detailed trouble shooting.

For fine tuning of the system and system setpoints, please refer to your Technician's IOM.

WARRANTY INFORMATION

COMMERCIAL WARRANTY

Warranty. For goods sold to commercial buyers, Seller warrants the goods sold to Buyer hereunder (with the exception of membranes, seals, gaskets, elastomer materials, coatings and other "wear parts" or consumables all of which are not warranted except as otherwise provided in the quotation or sales form) will be (i) be built in accordance with the specifications referred to in the quotation or sales form, if such specifications are expressly made a part of this Agreement, and (ii) free from defects in material and workmanship for a period of one (1) year from the date of installation or eighteen (18) months from the date of shipment (which date of shipment shall not be greater than thirty (30) days after receipt of notice that the goods are ready to ship), whichever shall occur first, unless a longer period is specified in the product documentation (the "Warranty").

Except as otherwise required by law, Seller shall, at its option and at no cost to Buyer, either repair or replace any product which fails to conform with the Warranty provided Buyer gives written notice to Seller of any defects in material or workmanship within ten (10) days of the date when any defects or non-conformance are first manifest. Under either repair or replacement option, Seller shall not be obligated to remove or pay for the removal of the defective product or install or pay for the installation of the replaced or repaired product and Buyer shall be responsible for all other costs, including, but not limited to, service costs, shipping fees and expenses. Seller shall have sole discretion as to the method or means of repair or replacement. Buyer's failure to comply with Seller's repair or replacement directions shall terminate Seller's obligations under this Warranty and render the Warranty void. Any parts repaired or replaced under the Warranty are warranted only for the balance of the warranty period on the parts that were repaired or replaced. Seller shall have no warranty obligations to Buyer with respect to any product or parts of a product that have been: (a) repaired by third parties other than Seller or without Seller's written approval; (b) subject to misuse, misapplication, neglect, alteration, accident, or physical damage; (c) used in a manner contrary to Seller's instructions for installation, operation and maintenance; (d) damaged from ordinary wear and tear, corrosion, or chemical attack; (e) damaged due to abnormal conditions, vibration, failure to properly prime, or operation without flow; (f) damaged due to a defective power supply or improper electrical protection; or (g) damaged resulting from the use of accessory equipment not sold or approved by Seller. In any case of products not manufactured by Seller, there is no warranty from Seller; however, Seller will extend to Buyer any warranty received from Seller's supplier of such products.

THE FOREGOING WARRANTY IS EXCLUSIVE AND IN LIEU OF ANY AND ALL OTHER EXPRESS OR IMPLIED WARRANTIES, GUARANTEES, CONDITIONS OR TERMS OF WHATEVER NATURE RELATING TO THE GOODS PROVIDED HEREUNDER, INCLUDING WITHOUT LIMITATION ANY IMPLIED WARRANTIES OF MERCHANTABILITY AND FITNESS FOR A PARTICULAR PURPOSE, WHICH ARE HEREBY EXPRESSLY DISCLAIMED AND EXCLUDED. EXCEPT AS OTHERWISE REQUIRED BY LAW, BUYER'S EXCLUSIVE REMEDY AND SELLER'S AGGREGATE LIABILITY FOR BREACH OF ANY OF THE FOREGOING WARRANTIES ARE LIMITED TO REPAIRING OR REPLACING THE PRODUCT AND SHALL IN ALL CASES BE LIMITED TO THE AMOUNT PAID BY THE BUYER FOR THE DEFECTIVE PRODUCT. IN NO EVENT SHALL SELLER BE LIABLE FOR ANY OTHER FORM OF DAMAGES, WHETHER DIRECT, INDIRECT, LIQUIDATED, INCIDENTAL, CONSEQUENTIAL, PUNITIVE, EXEMPLARY OR SPECIAL DAMAGES, INCLUDING BUT NOT LIMITED TO LOSS OF PROFIT, LOSS OF ANTICIPATED SAVINGS OR REVENUE, LOSS OF INCOME, LOSS OF BUSINESS, LOSS OF PRODUCTION, LOSS OF OPPORTUNITY OR LOSS OF REPUTATION.

LIMITED CONSUMER WARRANTY

Warranty. For goods sold for personal, family or household purposes, Seller warrants the goods purchased hereunder (with the exception of membranes, seals, gaskets, elastomer materials, coatings and other "wear parts" or consumables all of which are not warranted except as otherwise provided in the quotation or sales form) will be free from defects in material and workmanship for a period of one (1) year from the date of installation or eighteen (18) months from the product date code, whichever shall occur first, unless a longer period is provided by law or is specified in the product documentation (the "Warranty").

Except as otherwise required by law, Seller shall, at its option and at no cost to Buyer, either repair or replace any product which fails to conform with the Warranty provided Buyer gives written notice to Seller of any defects in material or workmanship within ten (10) days of the date when any defects or non-conformance are first manifest. Under either repair or replacement option, Seller shall not be obligated to remove or pay for the removal of the defective product or install or pay for the installation of the replaced or repaired product and Buyer shall be responsible for all other costs, including, but not limited to, service costs, shipping fees and expenses. Seller shall have sole discretion as to the method or means of repair or replacement. Buyer's failure to comply with Seller's repair or replacement directions shall terminate Seller's obligations under this Warranty and render this Warranty void. Any parts repaired or replaced under the Warranty are warranted only for the balance of the warranty period on the parts that were repaired or replaced. The Warranty is conditioned on Buyer giving written notice to Seller of any defects in material or workmanship of warranted goods within ten (10) days of the date when any defects are first manifest.

Seller shall have no warranty obligations to Buyer with respect to any product or parts of a product that have been: (a) repaired by third parties other than Seller or without Seller's written approval; (b) subject to misuse, misapplication, neglect, alteration, accident, or physical damage; (c) used in a manner contrary to Seller's instructions for installation, operation and maintenance; (d) damaged from ordinary wear and tear, corrosion, or chemical attack; (e) damaged due to abnormal conditions, vibration, failure to properly prime, or operation without flow; (f) damaged due to a defective power supply or improper electrical protection; or (g) damaged resulting from the use of accessory equipment not sold or approved by Seller. In any case of products not manufactured by Seller, there is no warranty from Seller; however, Seller will extend to Buyer any warranty received from Seller's supplier of such products.

THE FOREGOING WARRANTY IS PROVIDED IN PLACE OF ALL OTHER EXPRESS WARRANTIES. ALL IMPLIED WARRANTIES, INCLUDING BUT NOT LIMITED TO THE IMPLIED WARRANTIES OF MERCHANTABILITY AND FITNESS FOR A PARTICULAR PURPOSE, ARE LIMITED TO ONE (1) YEAR FROM THE DATE OF INSTALLATION OR EIGHTEEN (18) MONTHS FROM THE PRODUCT DATE CODE, WHICHEVER SHALL OCCUR FIRST. EXCEPT AS OTHERWISE REQUIRED BY LAW, BUYER'S EXCLUSIVE REMEDY AND SELLER'S AGGREGATE LIABILITY FOR BREACH OF ANY OF THE FOREGOING WARRANTIES ARE LIMITED TO REPAIRING OR REPLACING THE PRODUCT AND SHALL IN ALL CASES BE LIMITED TO THE AMOUNT PAID BY THE BUYER FOR THE DEFECTIVE PRODUCT. IN NO EVENT SHALL SELLER BE LIABLE FOR ANY OTHER FORM OF DAMAGES, WHETHER DIRECT, INDIRECT, LIQUIDATED, INCIDENTAL, CONSEQUENTIAL, PUNITIVE, EXEMPLARY OR SPECIAL DAMAGES, INCLUDING BUT NOT LIMITED TO LOSS OF PROFIT, LOSS OF ANTICIPATED SAVINGS OR REVENUE, LOSS OF INCOME, LOSS OF BUSINESS, LOSS OF PRODUCTION, LOSS OF OPPORTUNITY OR LOSS OF REPUTATION.

Some states do not allow limitations on how long an implied warranty lasts, so the above limitation may not apply to you. Some states do not allow the exclusion or limitation of incidental or consequential damages, so the above exclusions may not apply to you. This warranty gives you specific legal rights, and you may also have other rights which may vary from state to state.

To make a warranty claim, check first with the dealer from whom you purchased the product or call the following number for the name and location of the nearest dealer providing warranty service. For Goulds Water Technology contact 315-568-7123. For all other products, contact 847-966-3700.

Xylem |'zīləm|

- 1) The tissue in plants that brings water upward from the roots;
- 2) a leading global water technology company.

We're 12,500 people unified in a common purpose: creating innovative solutions to meet our world's water needs. Developing new technologies that will improve the way water is used, conserved, and re-used in the future is central to our work. We move, treat, analyze, and return water to the environment, and we help people use water efficiently, in their homes, buildings, factories and farms. In more than 150 countries, we have strong, long-standing relationships with customers who know us for our powerful combination of leading product brands and applications expertise, backed by a legacy of innovation.

For more information on how Xylem can help you, go to www.xyleminc.com



Xylem Inc.
10661 Newkirk Street
Dallas, TX 75220

www.bellgossett.com

Bell & Gossett is a trademark of Xylem Inc. or one of its subsidiaries.
© 2014 Xylem Inc. 10-001-275 REV0 July 2014