

INSTRUCTION MANUAL

AC5659D

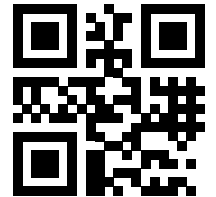

# G&L Pumps Series A-C 8100 Base Mounted Centrifugal Pump

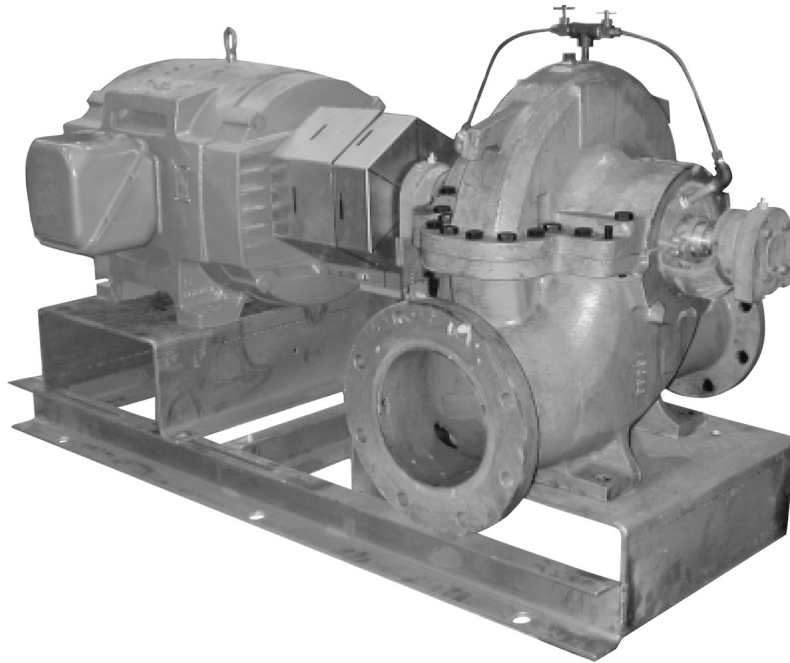

# Table of Contents

<b>1 Introduction and Safety</b> .....	<b>3</b>
1.1 Introduction.....	3
1.2 Safety.....	3
1.2.1 Safety terminology and symbols.....	3
1.2.2 Safety instruction decals.....	4
1.3 User safety.....	5
1.3.1 Wash the skin and eyes.....	6
1.4 Protecting the environment.....	6
<b>2 Transportation and Storage</b> .....	<b>7</b>
2.1 Examine the delivery.....	7
2.1.1 Examine the package.....	7
2.1.2 Examine the unit.....	7
2.2 Safe handling requirements.....	7
2.3 Storage requirements.....	10
<b>3 Product Description</b> .....	<b>11</b>
3.1 General description.....	11
3.2 Operational specifications.....	11
3.3 Nameplate information.....	12
<b>4 Installation</b> .....	<b>13</b>
4.1 Preinstallation.....	13
4.1.1 Pump location guidelines.....	13
4.1.2 Typical installation.....	14
4.1.3 Foundation requirements.....	14
4.1.4 Level the base on a concrete foundation .....	15
4.1.5 Grout the baseplate.....	16
4.2 Coupling alignment.....	16
4.2.1 Prepare for alignment.....	16
4.2.2 Align the pump using a straight edge and calipers.....	17
4.2.3 Align the pump using a dial indicator.....	18
4.2.4 Final alignment.....	19
4.2.5 Optional alignment procedure.....	19
4.2.6 Dowel the pump and driving unit.....	19
4.2.7 Coupler limitations.....	20
4.3 Piping checklists.....	20
4.3.1 Piping checklist.....	20
4.3.2 Suction piping checklist.....	21
<b>5 Commissioning, Startup, Operation, and Shutdown</b> .....	<b>24</b>
5.1 Preparation for startup.....	24
5.1.1 Pre-start checks.....	24
5.1.2 Priming.....	25
5.1.3 Starting.....	25
5.1.4 Operating checks.....	25
5.1.5 Check the rotation.....	25
5.1.6 Freezing protection.....	26
5.1.7 Change the rotation.....	26

<b>6 Maintenance.....</b>	<b>28</b>
6.1 Maintenance schedule.....	28
6.2 Flood-damaged pumps.....	29
6.3 Bearing maintenance.....	29
6.3.1 Regrease the grease-lubricated bearings.....	29
6.3.2 Lubricating grease requirements.....	30
6.4 Shaft-seal maintenance.....	30
6.4.1 Mechanical seal maintenance.....	30
6.4.2 Packed stuffing box maintenance.....	31
6.5 Cleaning without dismantling the pump.....	31
6.6 Disassembly.....	31
6.6.1 Disassembly precautions.....	31
6.6.2 Drain the pump.....	32
6.6.3 Remove the hex coupling guard.....	32
6.6.4 Disassemble the pump with mechanical seal on the shaft.....	33
6.6.5 Disassemble the pump with mechanical seals on shaft sleeve.....	34
6.6.6 Disassemble the pump with packing.....	36
6.7 Pre-assembly inspections.....	37
6.7.1 Replacement guidelines.....	37
6.7.2 Shaft and sleeve inspection.....	38
6.8 Dimensions.....	38
6.9 Reassembly.....	41
6.9.1 Reassemble the pump with mechanical seal on the shaft.....	41
6.9.2 Reassemble the pump with the mechanical seals on the shaft sleeve.....	44
6.9.3 Reassemble the pump with packing.....	46
6.9.4 Install the hex coupling guard.....	49
6.9.5 Assembly references.....	50
<b>7 Troubleshooting.....</b>	<b>51</b>
7.1 Operation troubleshooting.....	51
<b>8 Product warranty.....</b>	<b>55</b>

# 1 Introduction and Safety

## 1.1 Introduction

### Purpose of this manual

The purpose of this manual is to provide necessary information for:

- Installation
- Operation
- Maintenance



### CAUTION:

Read this manual carefully before installing and using the product. Improper use of the product can cause personal injury and damage to property, and may void the warranty.

### NOTICE:

Save this manual for future reference, and keep it readily available at the location of the unit.

## 1.2 Safety



### WARNING:

- The operator must be aware of safety precautions to prevent physical injury.
- Operating, installing, or maintaining the unit in any way that is not covered in this manual could cause death, serious personal injury, or damage to the equipment. This includes any modification to the equipment or use of parts not provided by Xylem. If there is a question regarding the intended use of the equipment, please contact a Xylem representative before proceeding.
- Do not change the service application without the approval of an authorized Xylem representative.



### CAUTION:

You must observe the instructions contained in this manual. Failure to do so could result in physical injury, damage, or delays.

### 1.2.1 Safety terminology and symbols



#### About safety messages

It is extremely important that you read, understand, and follow the safety messages and regulations carefully before handling the product. They are published to help prevent these hazards:

- Personal accidents and health problems
- Damage to the product and its surroundings
- Product malfunction



#### Hazard levels

Hazard level	Indication
 <b>DANGER:</b>	A hazardous situation which, if not avoided, will result in death or serious injury

Hazard level	Indication
 <b>WARNING:</b>	A hazardous situation which, if not avoided, could result in death or serious injury
 <b>CAUTION:</b>	A hazardous situation which, if not avoided, could result in minor or moderate injury
<b>NOTICE:</b>	Notices are used when there is a risk of equipment damage or decreased performance, but not personal injury.

Special symbols

Some hazard categories have specific symbols, as shown in the following table.

Electrical hazard	Magnetic fields hazard
 <b>Electrical Hazard:</b>	 <b>CAUTION:</b>

1.2.2 Safety instruction decals



Alert symbol

**WARNING:**  
Do NOT exceed the maximum working pressure of the pump. This information is listed on the nameplate of the pump.

	This safety alert symbol is used in manuals and on the safety instruction decals on the pump to draw attention to safety-related instructions. When used, the safety alert symbol means that failure to follow the instructions may result in a safety hazard.
---	---

Decals

Make sure your pump has these safety instruction decals and that they are located as this figure shows. If the decals are missing or illegible, contact your local sales and service representative for a replacement.

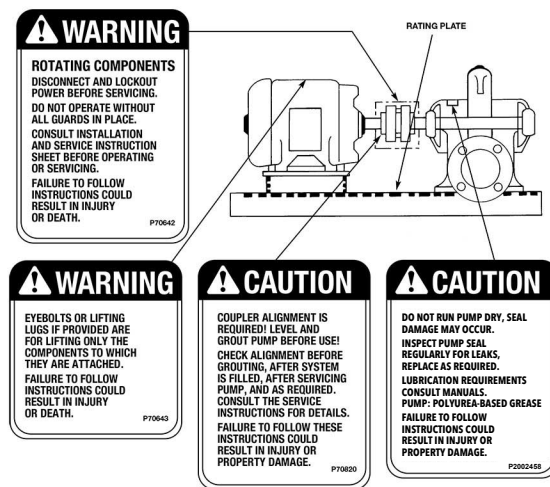

Make sure that all safety instruction decals are always clearly visible and readable.

## 1.3 User safety

### General safety rules

These safety rules apply:

- Always keep the work area clean.
- Pay attention to the risks presented by gas and vapors in the work area.
- Avoid all electrical dangers. Pay attention to the risks of electric shock or arc flash hazards.
- Always bear in mind the risk of drowning, electrical accidents, and burn injuries.

### Safety equipment

Use safety equipment according to the company regulations. Use this safety equipment within the work area:

- Hard hat
- Safety goggles, preferably with side shields
- Protective shoes
- Protective gloves
- Gas mask
- Hearing protection
- First-aid kit
- Safety devices

---

#### NOTICE:

Never operate a unit unless safety devices are installed. Also see specific information about safety devices in other chapters of this manual.

---

### Electrical connections

Electrical connections must be made by certified electricians in compliance with all international, national, state, and local regulations. For more information about requirements, see sections dealing specifically with electrical connections.

### Precautions before work

Observe these safety precautions before you work with the product or are in connection with the product:

- Provide a suitable barrier around the work area, for example, a guard rail.
- Make sure that all safety guards are in place and secure.
- Make sure that you have a clear path of retreat.

- Make sure that the product cannot roll or fall over and injure people or damage property.
- Make sure that the lifting equipment is in good condition.
- Use a lifting harness, a safety line, and a breathing device as required.
- Allow all system and pump components to cool before you handle them.
- Make sure that the product has been thoroughly cleaned.
- Disconnect and lock out power before you service the pump.
- Check the explosion risk before you weld or use electric hand tools.

### 1.3.1 Wash the skin and eyes

Follow these procedures for chemicals or hazardous fluids that have come into contact with your eyes or your skin:

Condition	Action
Chemicals or hazardous fluids in eyes	<ol style="list-style-type: none"> <li>1. Hold your eyelids apart forcibly with your fingers.</li> <li>2. Rinse the eyes with eyewash or running water for at least 15 minutes.</li> <li>3. Seek medical attention.</li> </ol>
Chemicals or hazardous fluids on skin	<ol style="list-style-type: none"> <li>1. Remove contaminated clothing.</li> <li>2. Wash the skin with soap and water for at least 1 minute.</li> <li>3. Seek medical attention, if necessary.</li> </ol>

## 1.4 Protecting the environment

### Emissions and waste disposal

Observe the local regulations and codes regarding:

- Reporting of emissions to the appropriate authorities
- Sorting, recycling and disposal of solid or liquid waste
- Clean-up of spills

### Exceptional sites



---

#### CAUTION: Radiation Hazard

Do NOT send the product to Xylem if it has been exposed to nuclear radiation, unless Xylem has been informed and appropriate actions have been agreed upon.

---

### Recycling guidelines

Always follow local laws and regulations regarding recycling.

# 2 Transportation and Storage

## 2.1 Examine the delivery

### 2.1.1 Examine the package

1. Examine the package for damaged or missing items upon delivery.
2. Record any damaged or missing items on the receipt and freight bill.
3. If anything is out of order, then file a claim with the shipping company.  
If the product has been picked up at a distributor, make a claim directly to the distributor.

### 2.1.2 Examine the unit

1. Remove packing materials from the product.  
Dispose of all packing materials in accordance with local regulations.
2. To determine whether any parts have been damaged or are missing, examine the product.
3. If applicable, unfasten the product by removing any screws, bolts, or straps.  
Use care around nails and straps.
4. If there is any issue, then contact a sales representative.

#### Shipping information

- Pumps and drivers are normally shipped from the factory mounted and painted with primer and one finish coat.
- Couplings are shipped either assembled or have the coupling hubs mounted on the shafts and the connecting members removed.
- When the connecting members are removed, they will be packaged in a separate container and shipped with the pump or attached to the base plate.

#### Shaft alignment

- Shafts are in alignment when the unit is shipped; however, misalignment can occur due to shipping.
- Refer to recommended alignment procedures in this manual if it is necessary to realign the shaft.

## 2.2 Safe handling requirements



#### WARNING:

- Personal protective equipment should be worn when handling this equipment.
- Transportation & installation of this equipment should only be performed by qualified personnel.
- A professional rigging company should be consulted before lifting the pump assembly.
- Only use properly sized, certified lifting equipment & lifting devices, including slings, suitably rated for the weights to be lifted.
- Slings, when used, must be of identical materials to avoid differences in stretch rates.
- Do not use lifting devices that are frayed, kinked, unmarked, or worn.
- Lifting eyebolts fitted on single components of the assembly (pump or motor) must not be used to lift the complete assembly.
- Failure to observe these instructions could result in equipment or property damage, serious injury, or death.

The pump assembly can arrive in a variety of ways:

- Pump end only (bare pump)
- Pump less motor
- Pump, motor, & baseplate

Use the following recommended ways of handling HSC pump assemblies.

- The pump assembly should remain horizontal during transport and lifting.
- Lifting the pump end only (bare pump) should be done by placing one end of the slings around or as close to the casing barrel as possible. After the slings are attached to the unit, recheck to ensure they are securely in place. Make sure the slings are adjusted to obtain an even lift.

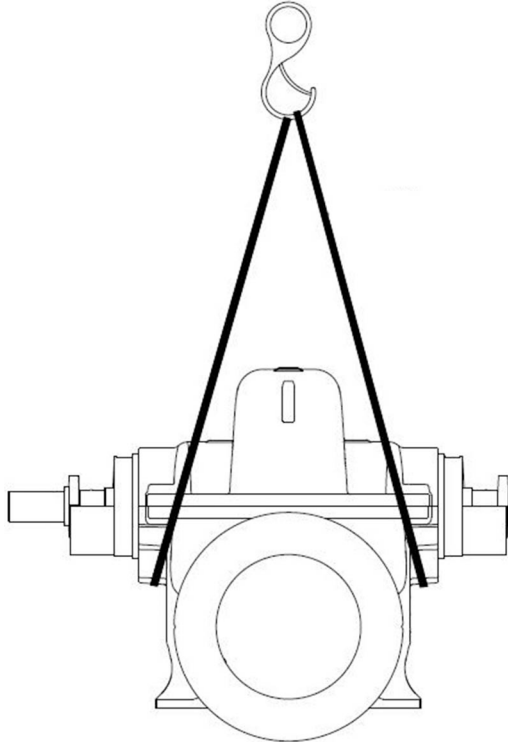

Figure 1: Lifting pump end only with nylon sling, chain, or wire rope

- Lifting the pump less motor or the pump, motor, & baseplate should be done by utilizing a forklift under the entire unit. Always take extra precaution to ensure the weight is balanced & equally distributed across both forks. When the baseplate of the assembly is structural channel construction, the pump and base plate should be set in place first. The motor should then be separately lifted & mounted to the unit.
- Pump, base, and driver assemblies where the base length exceeds 100 inches may not be safe to lift as a complete assembly. Damage to the baseplate may occur. If the driver has been mounted on the baseplate at the factory, it is safe to lift the entire assembly. If driver has not been mounted at the factory and the overall baseplate length exceeds 100 inches, do not lift the entire assembly consisting of pump, base, and driver. Instead lift the pump and baseplate to its final location without the driver. Then mount the driver.

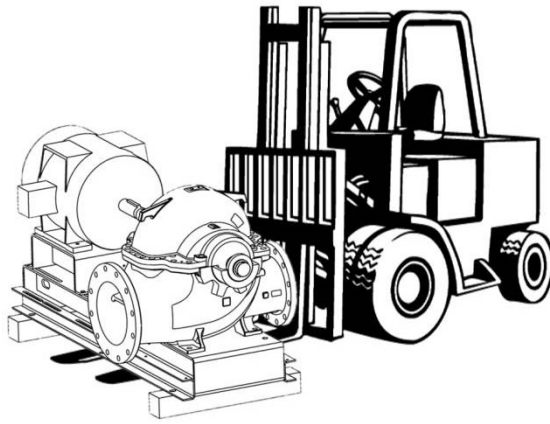

Figure 2: Lift using a forklift

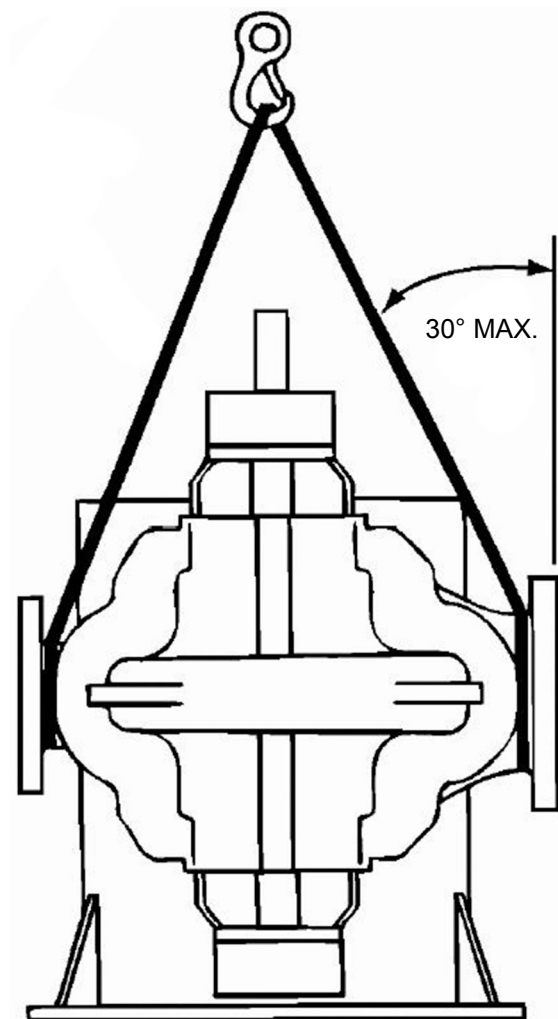

Figure 3: Vertical - Half Pedestal - Model 200

- Place nylon sling, chain or wire rope around both flanges. Use a latch hook or standard shackle and end loops. Be sure the lifting equipment is of sufficient length to keep the lift angle less than 30° from the vertical (See Figure 3).

### Storage location

The product must be stored in a covered and dry location free from heat, dirt, and vibrations.

---

**NOTICE:**

Protect the product against humidity, heat sources, and mechanical damage.

---

**NOTICE:**

Do not place heavy weights on the packed product.

---

## 2.3 Storage requirements

If the unit will not be installed and put into operation immediately upon arrival at the site, or for an extended shutdown after the unit is in operation, the following requirements for short-term storage apply:

- Store in a covered and dry location.
- Store the unit free from excessive cold or heat (below 32°F and above 110°F), dirt, and vibration.
- Rotate the shaft by hand several times (10–15 turns) at least every 30 days.

For initial storage longer than three months, or for pump shut down after being in operation longer than three months, contact your local sales and service representative for long-term storage guidelines.

# 3 Product Description

## 3.1 General description

### Description

The pump is a centrifugal, frame-mounted pump. The following pump features make it easy to install, operate, and service:

- High efficiency
- Rugged construction
- Compact design
- Foot-mounted volute
- Center drop out coupler
- regreasable bearings
- Horizontal split case

### Mechanical seal types

Packing	
Mechanical seal	<ul style="list-style-type: none"> <li>• Preferred over packing on some applications because of better sealing qualities and longer serviceability.</li> <li>• Leakage is eliminated when a seal is properly installed and normal life is much greater than that of packing on similar applications.</li> <li>• Pumps containing single mechanical seals normally utilize the pumped liquid to lubricate the seal faces. This method is preferred when the pumped liquid is neither abrasive nor corrosive.</li> </ul>

### Intended applications



#### WARNING:

This product can expose you to chemicals including Lead, which is known to the State of California to cause cancer and birth defects or other reproductive harm. For more information go to: [www.P65Warnings.ca.gov](http://www.P65Warnings.ca.gov).

The pump's bronze fitted construction make it ideal for use with the following liquids:

- Unheated domestic and fresh water
- Boiler feed water
- Condensate
- Hydronic cooling or heating
- Pressure boosting
- General pumping
- Benign liquids

## 3.2 Operational specifications

### Maximum working pressure

The maximum working pressure is listed on the pump nameplate.

**Mechanical seal specifications**

Seal type	Parameter	Value
Standard self-flushing	pH range limits for BUNA	pH 7-9
	Liquid temperature range that complies with the pH range limits for BUNA	-20°F to 225°F (-29°C to 107°C)
	pH range limits for EPT	pH 7-11
	Liquid temperature range that complies with the pH range limits for EPT	-20°F to 250°F (-29°C to 121°C)

**Table notes**

1. For use on closed or open systems which are relatively free of dirt and/or other abrasive particles.

### 3.3 Nameplate information

The pump nameplate gives identification and rating information about the pump.

Permanent records for this pump are kept by the serial number and it must be used with all correspondence and spare parts orders.

**Nameplate**

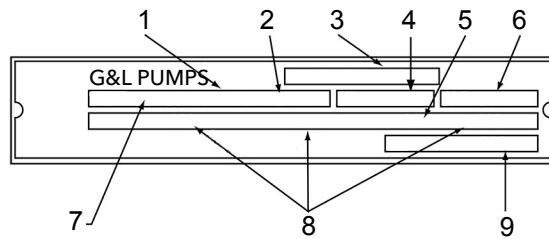

1. Impeller diameter
2. Pump rotation – for example, LHR = left hand rotation
3. Pump size – for example, 8 x 8 x 17M
4. Serial number – for example, 1-21937-1-1
5. Driver HP
6. Identification number – for example, Month and year = CWP-11
7. Pump series and model number
8. Duty points – GPM, feet, RPM
9. Maximum working pressure

# 4 Installation

## 4.1 Preinstallation

### Precautions



---

**WARNING:**

- When installing in a potentially explosive environment, make sure that the motor is properly certified.
  - You must ground (earth) all electrical equipment. This applies to the pump equipment, the driver, and any monitoring equipment. Test the ground (earth) lead to verify that it is connected correctly.
  - Motors without built-in protection must be provided with contactors and thermal overload protection for single-phase motors, or starters with heaters for three-phase motors. (See the nameplate on the drive unit to select properly-sized overloads.)
- 

**NOTICE:**

Supervision by an authorized Xylem representative is recommended to ensure proper installation. Failure to do so may result in equipment damage or decreased performance.

---

Evaluate the installation in order to determine that the Net Positive Suction Head Available (NPSH<sub>A</sub>) meets or exceeds the Net Positive Suction Head Required (NPSH<sub>R</sub>), as stated by the pump performance curve.

### 4.1.1 Pump location guidelines



---

**WARNING:**

Assembled units and their components are heavy. Failure to properly lift and support this equipment can result in serious physical injury and/or equipment damage. Lift equipment only at the specifically identified lifting points. Lifting devices such as eyebolts, slings, and spreaders must be rated, selected, and used for the entire load being lifted.

---

Guideline	Explanation/comment
Keep the pump as close to the liquid source as practically possible. If the pump is not on a closed system, locate the pump so that the fewest number of bends or elbows in the suction pipe are needed.	This minimizes the friction loss and keeps the suction piping as short as possible.
Make sure that the space around the pump is sufficient.	This facilitates ventilation, inspection, maintenance, and service.
If you require lifting equipment such as a hoist or tackle, make sure that there is enough space above the pump.	This makes it easier to properly use the lifting equipment and safely remove and relocate the components to a safe location.
Protect the unit from weather and water damage due to rain, flooding, and freezing temperatures.	This is applicable if nothing else is specified.
Do not install and operate the equipment in closed systems unless the system is constructed with properly-sized safety devices and control devices.	Acceptable devices: <ul style="list-style-type: none"> <li>• Pressure relief valves</li> <li>• Compression tanks</li> <li>• Pressure controls</li> <li>• Temperature controls</li> <li>• Flow controls</li> </ul> If the system does not include these devices, consult the engineer or architect in charge before you operate the pump.

Guideline	Explanation/comment
Take into consideration the occurrence of unwanted noise and vibration.	The best pump location for noise and vibration absorption is on a concrete floor with subsoil underneath.
If the pump location is overhead, undertake special precautions to reduce possible noise transmission.	Consider a consultation with a noise specialist.
Make sure there is a suitable power source available for the pump driver.	The electrical supply must match the motor nameplate specifications.

### 4.1.2 Typical installation

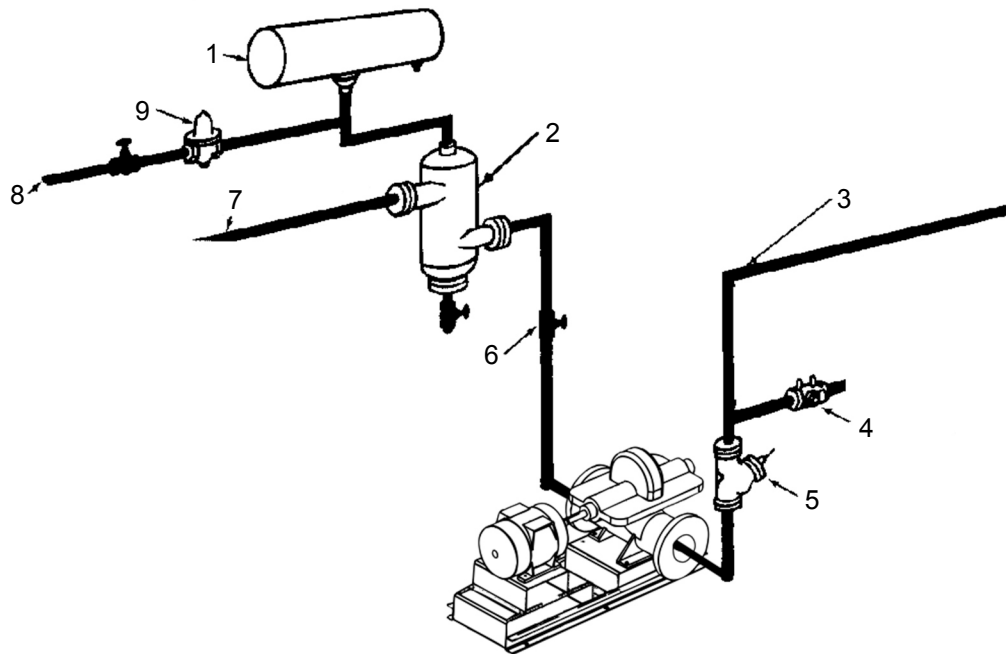

1. Compression tank (locate the compression tank on the suction side of the pump)
2. Air separator
3. Supply to system
4. Circuit setter
5. Triple duty valve
6. Isolation valve
7. From boiler chiller or converter
8. Cold water supply
9. Reducing valve

### 4.1.3 Foundation requirements

#### Requirements

- A substantial foundation and footing should be built to suit local conditions and form a rigid support to maintain alignment.
- The foundation must be able to absorb any type of vibration and form a permanent, rigid support for the unit.
- Pour the foundation without interruption to within 1/2 to 1-1/2 inches of the finished height.
- The top surface of the foundation should be scored and grooved before the concrete sets. This provides a bonding surface for the grout.
- Provide a flat, substantial concrete foundation in order to prevent strain and distortion when you tighten the foundation bolts.
- Sleeve-type and J-type foundation bolts are most commonly used. Both designs allow movement for the final bolt adjustment.
- Allow the foundation to cure for several days before you proceed with the pump installation.

## Diagram

- An optional 4-inch long tube around the bolts at the top of the concrete allows some flexibility in bolt alignment to match the holes in the baseplate.
- Allow enough bolt length for grout, shims, lower baseplate flange, nuts, and washers.

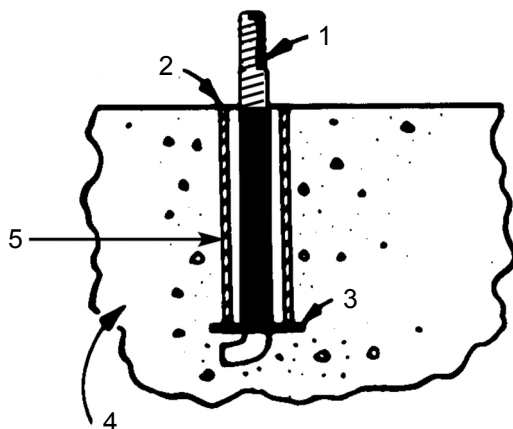

1. Foundation bolt
2. Pipe sleeve
3. Washer
4. Built-up concrete foundation
5. Optional 4-inch tube around the bolts

#### 4.1.4 Level the base on a concrete foundation

1. Place the pump on its concrete foundation.
2. Place 1.00 in. (25.40 mm) thick steel shims or wedges on both sides of each anchor bolt in order to support the pump .

This also provides a means of leveling the base.

Add and remove shims under the base to level and plumb the pump shaft and flanges. The baseplate does not have to be level.

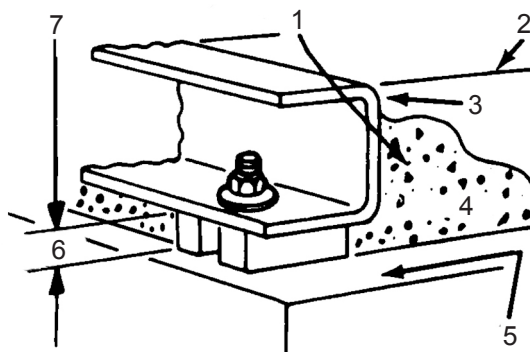

1. Locate the shims to allow removal after grouting.
  2. Grout only to top of base rail
  3. Pump base rail
  4. Grout
  5. Concrete foundation
  6. 1" (25.40 mm) Gap
  7. Allow 1" for shims. Place on both sides of anchor bolts.
3. Draw anchor bolts tight against the base and observe pump and motor shafts or coupling hubs for alignment.
 

Temporarily remove the coupling guard for checking alignment.
  4. If the alignment needs improvement, add shims or wedges at appropriate positions under the base so that retightening of anchor nuts shifts shafts into closer alignment. Repeat this procedure until a reasonable alignment is reached.
 

A reasonable alignment is that which is agreed upon by the pump contractor and the accepting facility. Final alignment procedures are covered in "Alignment procedures."

5. Check to make sure that the piping can be aligned to the pump flanges without placing pipe strain on either flange.
6. Grout the baseplate. See "Grout the baseplate."

### 4.1.5 Grout the baseplate

Required equipment:

- Cleaners: Do not use an oil-based cleaner because the grout will not bond to it. See the instructions provided by the grout manufacturer.
  - Grout: Non-shrink grout is required.
1. Clean all the areas of the baseplate that will come into contact with the grout.
  2. Build a dam around the foundation.
  3. Thoroughly wet the foundation that will come into contact with the grout.
  4. Pour grout through the grout hole into the baseplate up to the level of the dam.  
When you pour the grout, remove air bubbles from it by using one of these methods:
    - Puddle with a vibrator.
    - Pump the grout into place.
  5. After the grout has thoroughly hardened, check the foundation bolts and tighten if necessary. Check alignment after tightening the bolts.
  6. After the grout has dried, apply an oil base paint to the exposed edges to prevent moisture from coming in contact with the grout.

## 4.2 Coupling alignment



### WARNING:

Always disconnect and lock out power to the driver before you perform any installation or maintenance tasks. Failure to disconnect and lock out driver power will result in serious physical injury.

### Alignment guidelines

Follow these guidelines when you align the coupling:

- Only perform alignment by moving or shimming the motor.
- Make allowances for thermal expansion during cold alignment so that the coupling is aligned at operating temperature.
- Since adjustments in one direction can alter the alignment in another direction, check the alignment in all directions after you make a correction.
- Make sure that the pump and motor bolts are tight when you take all measurements.
- Perform a final alignment check after the unit reaches its final operating temperature.
- Make final alignment by moving and shimming the motor on the baseplate until the coupling hubs are within the recommended tolerances measured in total runout.

### NOTICE:

Follow shaft alignment procedures in order to prevent catastrophic failure of drive components or unintended contact of rotating parts. Follow the coupling or v-belt drive installation and operation procedures from the coupling or v-belt manufacturer.

### 4.2.1 Prepare for alignment

1. Check the pump and motor shafts and remove any paint, burrs, and rust.
2. Slide the hubs and bushings on the shafts with keys.
3. Hold one half element on the hubs in order to determine the appropriate hub spacing.
4. If you use spacer elements with high speed rings, hold both half elements on the hubs in order to make sure the hubs do not interfere with the rings.
5. You can install the hubs with the hub extension facing in or out.

- Make sure the shaft extends into the hubs at least 0.8 times the diameter of the shaft.
6. Lightly fasten the hubs to the shafts in order to prevent them from moving during alignment.
  7. Align the hubs to the values shown in Maximum allowable misalignment for couplings.  
You can perform alignment with lasers, dial indicators, or with a straight edge and calipers.

#### 4.2.2 Align the pump using a straight edge and calipers

For standard sleeve type coupler with black rubber insert

Before aligning the coupler, make sure there is at least 1/8" end clearance between the sleeve and the two coupler halves.

1. Check the angular misalignment:

Tool	Procedure
Calipers	1. Measure the outside of one flange to the outside of the opposite flange at four points 90° apart. Do not rotate coupler. Misalignment of up to 1/64 per inch of coupler radius is permissible.
Feeler gauges	1. Insert feeler gauges between the coupling faces at various points around the circumference. Do not rotate the shafts. 2. Reposition the equipment until the difference between the minimum and maximum distance values is within the permissible range.

2. Check the parallel alignment:
  - a) Place a straight edge across the two coupler halves.
  - b) Measure the maximum offset at four points 90° apart. Do not rotate coupler.
  - c) Reposition the equipment until the gap is within the 1/64" permissible offset.

A coupling with a 3° angular misalignment will have a 0.191 in. (0.485 cm) difference in measurements between L1 and L2. This is within the 0° to 4° misalignment that is allowed for that size of coupling.

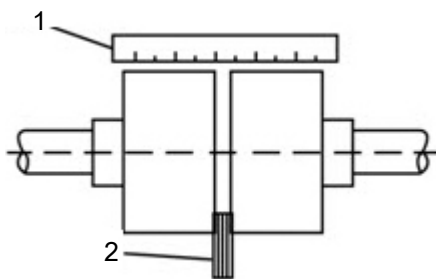

1. Straight edge
2. Feeler gauge

Figure 4: Check the alignment using a straight edge - correct

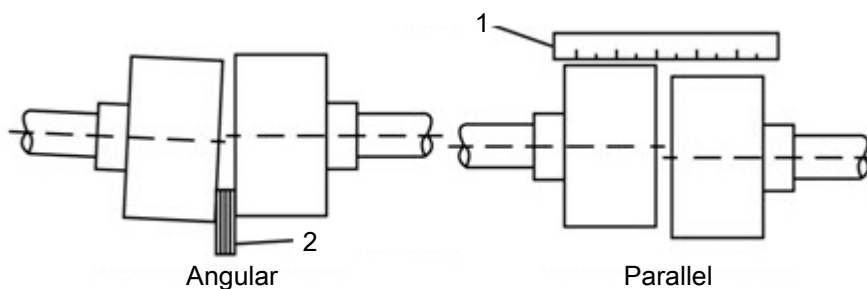

1. Straight edge
2. Feeler gauge

Figure 5: Check the alignment using a straight edge - incorrect

In the following Figure, the arrows show the angular misalignment:

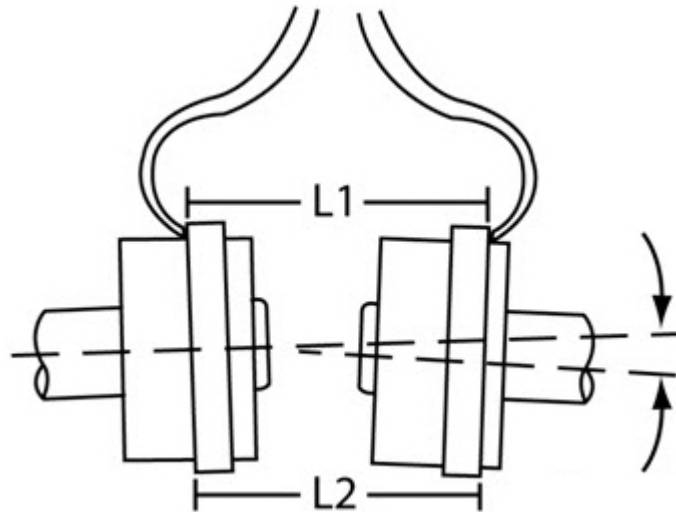
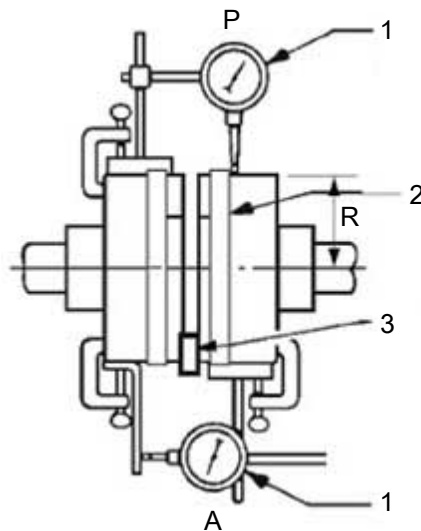

Figure 6: Check the alignment using calipers

### 4.2.3 Align the pump using a dial indicator

- Make sure that each hub is secured to its respective shaft and that all connecting and/or spacing elements are removed at this time.
  - The gap between the coupling hubs is set by the manufacturer before the units are shipped. However, this dimension should be checked. Refer to the coupling manufacturer’s specifications supplied with the unit.
1. Check the angular misalignment:
    - a) Mount the dial indicator base to one coupling half, or shaft.
    - b) Position the dial indicator button on the front face or rear face of the opposite coupling half.
    - c) Mark the index lines on the coupling halves as the following Figure shows:



A	Angular alignment
P	Parallel alignment
1	Dial indicators
2	Index line

**Figure 7: Pump alignment via dial indicator**

- d) Set the dial to zero.
  - e) Rotate both coupling halves together and make sure that the index lines remain matched.
  - f) Reposition the equipment until the offset is within the permissible value.
2. Check the parallel misalignment:
    - a) Mount the dial indicator base to one coupling half, or shaft.
    - b) Position the dial indicator button on the outside diameter of the opposite coupling half.
    - c) Set the dial to zero.
    - d) Rotate both coupling halves together and make sure that the index lines remain matched.
    - e) Reposition the equipment until the offset is within the permissible value.
    - f) Assemble coupling. Tighten all bolts and set screw(s). It may be necessary to repeat steps for a final check.

For single element couplings, a satisfactory parallel misalignment is .004" T.I.R., while a satisfactory angular misalignment is .004" T.I.R. per inch of radius R.

#### 4.2.4 Final alignment

You cannot perform the final alignment until you initially operate the pump long enough to reach operating temperature. When the pump reaches the normal operating temperature, then secure the pump and re-check the alignment. Make sure that you compensate for temperature accordingly.

---

#### NOTICE:

Elastomeric couplings are specifically designed to accommodate angular shaft misalignment, as well as parallel offset of the pump and motor shafts. However, the amount of the offset and/or misalignment depends on the style of the applied flexible coupling. If you do not correct this coupling misalignment, there is a significant impact on the overall life of the mechanical seals and the bearings of the pump.

---

#### 4.2.5 Optional alignment procedure

If desired, the pump and motor feet can be doweled to the base after final alignment is complete. This should not be done until the unit has been run for a sufficient length of time and alignment is within the tolerance. See doweling section.

**NOTE:** Pump may have been doweled to base at factory.

#### 4.2.6 Dowel the pump and driving unit

1. Drill holes through diagonally opposite feet and into the base. Holes must be of a diameter 1/64 inch less than the diameter of the dowel pins.
2. Ream the holes in feet and base to the proper diameter for the pins (light push fit). Clean out the chips.
3. Insert pins to be approximately flush with feet.

### 4.2.7 Coupler limitations

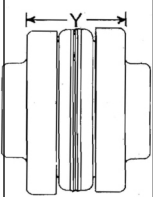
Brand	Suitable for variable speed application	Minimum recommended speed	Allowable installation misalignment limits			Y Dimension (inch) 	Maximum temperature	Minimum temperature
			Coupler size	Parallel (inch)	Angular (inch or degree)			
TB Wood's Sure-Flex (Neoprene sleeve)	Yes	50% of full speed	3	0.010	0.035	1.188	200°F	-0°F
			4	0.010	0.043	1.500		
			5	0.015	0.056	1.938		
			6	0.015	0.070	2.375		
			7	0.020	0.081	2.563		
			8	0.020	0.094	2.938		
			9	0.025	0.109	3.500		
			10	0.025	0.128	4.063		
			11	0.032	0.151	4.875		
			12	0.032	0.175	4.688		
			13	0.040	0.195	6.688		
			14	0.045	0.242	7.750		
			TB Wood's Sure-Flex (Hytrel Sleeve)	No	N/A	3		
4	-	-				-		
5	-	-				-		
6	0.010	0.016				2.375		
7	0.012	0.020				2.563		
8	0.015	0.025				2.938		
9	0.017	0.028				3.500		
10	0.020	0.032				4.063		
11	0.022	0.037				4.875		
12	0.025	0.042				5.688		
13	0.030	0.050				6.625		
14	0.035	0.060				7.750		

## 4.3 Piping checklists

### 4.3.1 Piping checklist



**WARNING:**

- The heating of water and other fluids causes volumetric expansion. The associated forces can cause the failure of system components and the release of high-temperature fluids. In order to prevent this, install properly sized and located compression tanks and pressure-relief valves. Failure to follow these instructions can result in serious personal injury or death, or property damage.
- Avoid serious personal injury and property damage. Make sure that the flange bolts are adequately torqued.
- Never force piping to make a connection with a pump.

Check	Explanation/Comment
Always run piping to the pump.	Do not move pump to pipe. This could make final alignment impossible.
Check that the suction and discharge piping are supported independently near the pump and properly aligned.	This helps to avoid strain on the pump when the flange bolts are tightened.
Check that pipe hangers or other supports are installed.	Place supports at necessary intervals.
Check if expansion joints are installed correctly.	When expansion joints are used in the piping system, they must be installed beyond the piping supports closest to the pump. Tie bolts should be used with expansion joints to prevent pipe strain. Do not install expansion joints next to the pump or in any way that would cause a strain on the pump resulting in system pressure changes.
Check that pipe size is larger at pump connections.	It is usually advisable to increase the size of both suction and discharge pipes at the pump connection to decrease the loss of head from friction.
Install piping as straight as possible to avoid unnecessary bends.	Use 45 degree or long sweep 90 degree fitting to decrease friction losses.
Make sure that all piping joints are air tight.	
Where flanged joints are used, assure that inside diameters match properly.	
Do not "spring" piping when making any connections.	
Provide for pipe expansion when hot fluids are to be pumped.	

### 4.3.2 Suction piping checklist

The sizing and installation of the suction piping is extremely important. It must be selected and installed so that pressure losses are minimized and sufficient liquid flows into the pump when it is started and operated. Many NPSH problems can be directly attributed to improper suction piping systems.

#### Piping checklist

Check	Explanation/comment	Checked
Keep the suction piping short in length, as direct as possible, and never smaller in diameter than the pump suction opening.	If the suction pipe is short, the pipe diameter can be the same size as the suction opening. If longer suction piping is required, pipes should be one or two sizes larger than the opening depending on piping length.	
Check that the elbows in the suction piping for horizontal double-suction pumps are installed per the Hydraulics Institute Standards since there is always an uneven turbulent flow around an elbow.	When there is an elbow in a position other than the vertical when in relation to the pump suction nozzle, this causes more liquid to enter one side of the impeller than the other. The result is highly unequalized thrust loads that overheat the bearings and cause rapid wear, which adversely affects the hydraulic performance. See the Example of unbalanced loading figure.	
Check that pipe reducers on the inlet side have no more than one pipe diameter reduction in a single reducer.	This avoids excessive turbulence and noise.	
When operating on a suction lift, check that the suction pipe slopes upward to the pump nozzle.	A horizontal suction line must have a gradual rise to the pump. Any high point in the pipe can become filled with air and prevent proper operation of the pump.	

Check	Explanation/comment	Checked
(Optional) You can install a short section of pipe adjacent to the suction flange such as Dutchman or a spool piece that is designed so that it can be readily dropped out of the line.	This facilitates the cleansing of the liquid passage of the pump without dismantling the pump. With this arrangement, anything that clogs the impeller is accessible with the removal of the spool piece or pipe section.	

**Example of unbalanced loading**

This figure shows the unbalanced loading of a double-suction impeller due to the uneven flow around an elbow that is adjacent to the pump:

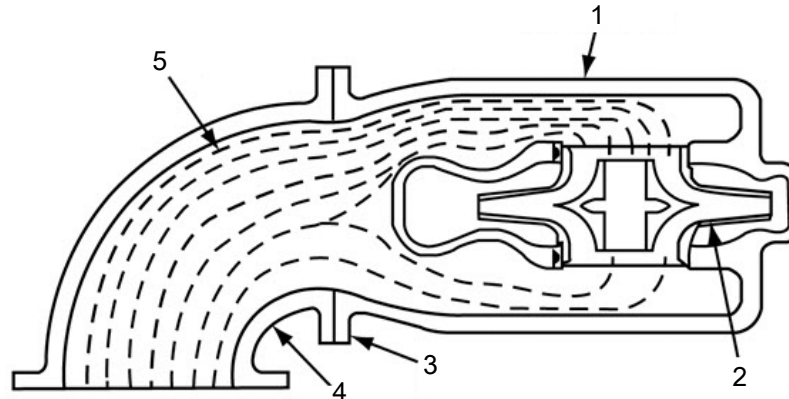

1. Pump casing
2. Impeller
3. Pump suction flange
4. Suction elbow
5. Water velocity increases here and causes a greater flow to one side of the impeller.

**Figure 8: Unbalanced loading of double-suction impeller**

**Examples**

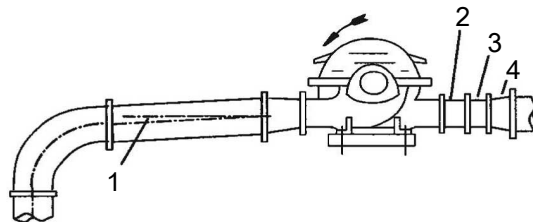

1. Level centerline of pipe
2. Check valve
3. Gate valve
4. Increaser

**Figure 9: Suction pipe installed with a gradual rise to the pump - correct**

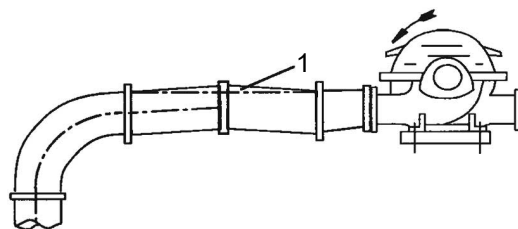

1. Air pocket

**Figure 10: Suction pipe installed with a gradual rise to the pump - incorrect**

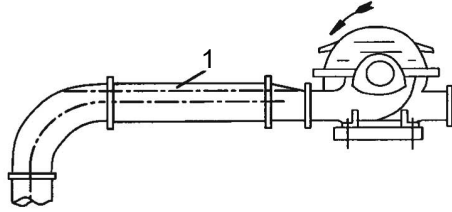

1. Air pocket

Figure 11: Suction pipe installed with a reducer - incorrect

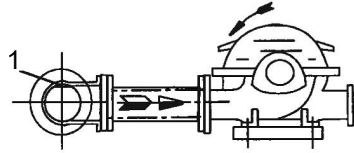

1. Air pocket

Figure 12: Incorrect

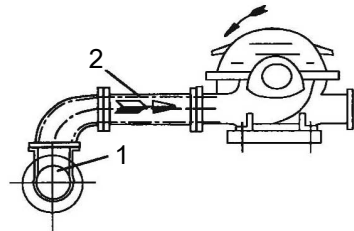

1. No air pockets  
2. Gradual rise

Figure 13: Correct

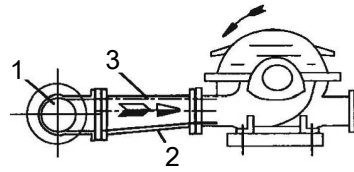

1. No air pockets  
2. Eccentric reducer  
3. Gradual rise

Figure 14: Gradual rise to the pump - correct

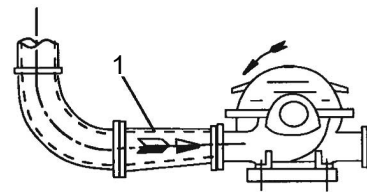

1. Distance plus eccentric reducer straightens the flow

Figure 15: Suction pipe above the pump - correct

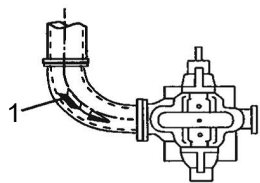

1. Path of the water

Figure 16: Suction pipe above the pump - incorrect

# 5 Commissioning, Startup, Operation, and Shutdown

## 5.1 Preparation for startup



---

**WARNING:**

- Failure to follow these precautions before you start the unit will lead to serious personal injury and equipment failure.
- Do not operate the pump below the minimum rated flows or with the suction or discharge valves closed. These conditions can create an explosive hazard due to vaporization of pumped fluid and can quickly lead to pump failure and physical injury.
- Always disconnect and lock out power to the driver before you perform any installation or maintenance tasks. Failure to disconnect and lock out driver power will result in serious physical injury.
- Operating the pump in reverse rotation can result in the contact of metal parts, heat generation, and breach of containment.
- Make sure that all components are properly guarded or insulated when operating at extremely high or low temperatures.

---

**NOTICE:**

- Verify the driver settings before you start any pump.
- Make sure that the warm-up rate does not exceed 2.5°F (1.4°C) per minute.

---

You must follow these precautions before you start the pump:

- Flush and clear the system thoroughly to remove dirt or debris in the pipe system in order to prevent premature failure at initial startup.
- If temperatures of the pumped fluid will exceed 200°F (93°C), then warm up the pump prior to operation. Circulate a small amount of fluid through the pump until the casing temperature is within 100°F (38°C) of the fluid temperature.

At initial startup, do not adjust the variable-speed drivers or check for speed governor or over-speed trip settings while the variable-speed driver is coupled to the pump. If the settings have not been verified, then uncouple the unit and refer to instructions supplied by the driver manufacturer.

### 5.1.1 Pre-start checks

Before initial start of the pump, make the following inspections:

1. Check alignment between pump and motor.
2. Check all connections to motor and starting device with wiring diagram. Check voltage, phase, and frequency on motor nameplate with line circuit.
3. Check suction and discharge piping and pressure gauges for proper operation.
4. Check impeller adjustment, see specific section for proper adjustment.
5. Turn rotating element by hand to assure that it rotates freely.
6. Check driver lubrication.
7. Assure that pump bearings are properly lubricated.
8. Assure that coupling is properly lubricated, if required.

9. Assure that pump is full of liquid (see priming) and all valves are properly set and operational, with the discharge valve closed, and the suction valve open.
10. Check rotation. Be sure that the driver operates in the direction indicated by the arrow on the pump casing as serious damage can result if the pump is operated with incorrect rotation. Check rotation each time the motor leads have been disconnected.

### 5.1.2 Priming

Type of installation	Procedure
Positive head on the suction	Open the suction and vent valve and allow the liquid to enter the casing.
Suction lift	Use other methods such as foot valves, ejectors or by manually filling the casing and suction line.

### 5.1.3 Starting

1. Close drain valves and valve in discharge line.
2. Open fully all valves in the suction line.
3. Prime the pump.  
NOTE: If the pump does not prime properly, or loses prime during start-up, it should be shut down and the condition corrected before the procedure is repeated.
4. When the pump is operating at full speed, open the discharge valve slowly. This should be done after start-up to prevent damage to pump by operating at zero flow.

### 5.1.4 Operating checks

1. Check the pump and piping to assure that there are no leaks.
2. Check and record pressure gauge readings for future reference.
3. Check and record voltage, amperage per phase, and kw if an indicating wattmeter is available.
4. Check bearings for lubrication and temperature. Normal temperature is 180°F maximum.
5. Make all pump output adjustments with the discharge line.



#### CAUTION:

- Do not throttle the suction line to adjust the pump output.
- Do not let heated pump temperature rise above 150°F.

### 5.1.5 Check the rotation



#### WARNING:

- Operating the pump in reverse rotation can result in the contact of metal parts, heat generation, and breach of containment.
- Always disconnect and lock out power to the driver before you perform any installation or maintenance tasks. Failure to disconnect and lock out driver power will result in serious physical injury.



#### CAUTION:

Never operate the pump without liquid supplied to mechanical seal. If you run a mechanical seal dry, even for a few seconds, this can cause seal damage. Physical injury can occur if a mechanical seal fails.

1. Unlock power to the driver.
2. Make sure that everyone is clear, and then jog the driver long enough to determine that the direction of rotation corresponds to the arrow on the pump.
3. Lock out power to the driver.

### 5.1.6 Freezing protection

---

**NOTICE:**

Do not expose an idle pump to freezing conditions. Drain all liquid that is inside the pump and connected pipes. Failure to do so can cause liquid to freeze and damage the pump.

---

Pumps that are shut down during freezing conditions should be protected by one of the following methods:

- Drain the pump; remove all liquids from the casing.
- Keep fluid moving in the pump and insulate or heat the pump to prevent freezing.

### 5.1.7 Change the rotation

The pump can be operated left hand or right hand when viewed from the pump end of the pump. If you wish to reverse the suction and discharge nozzles, this can be accomplished with the same pump as follows. **IMPORTANT:** Refer to the disassembly and assembly procedures in this manual for proper disassembly and assembly techniques.

1. Remove the impeller from the shaft, turn it 180° and replace it on the shaft. Note: Impeller can only come off from the outboard end.
2. With the rotating element out of the casing, remove the casing from the bedplate and turn 180°.
3. Set the rotating element back in the casing and reassemble the pump.
  - The impeller and casing are in the same relationship to each other as they were originally. The shaft and motor are also in the same relationship to each other as they were originally.
4. Reassemble pump and realign the coupling as called for in the alignment procedures.



---

**WARNING:**

Never operate a pump without a properly installed coupling guard. Personal injury will occur if you run the pump without a coupling guard.

---

5. The rotation of the motor must be changed by switching the motor leads.
  - Unless the motor rotation is reversed, the impeller will run backward.

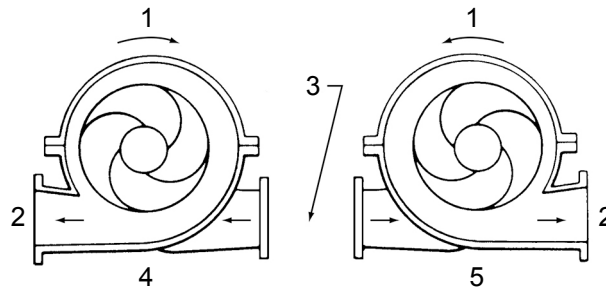

Figure 17: Correct relationship of impeller and casing

1. Rotation
2. Discharge
3. Suction
4. Left-hand rotation viewed from the pump end
5. Right-hand rotation viewed from the pump end

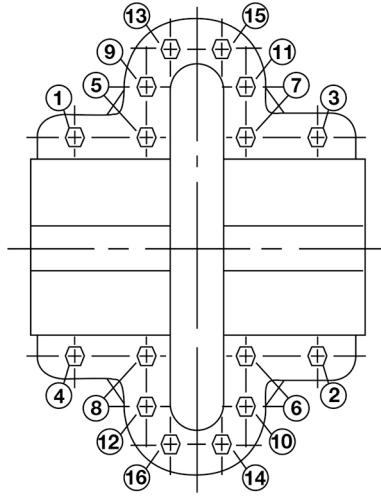

Figure 18: Main joint bolts

# 6 Maintenance

## 6.1 Maintenance schedule



---

**CAUTION:**

Shorten the inspection intervals if the pumped liquid is abrasive or corrosive, or if the environment is classified as potentially explosive.

---

---

**NOTICE:**

This timetable assumes that the unit has been constantly monitored after startup. Adjust the timetable for any extreme or unusual applications or conditions.

---

### Monthly inspections

Check the bearing temperature with a thermometer. Do not check the temperature by hand. If the bearings are running over 180°F (82°C), then there is too much or too little lubricant.

If changing the lubricant or adjusting to the proper level does not correct the condition, then disassemble and inspect the bearings.

### Three-month inspections

Perform these tasks every three months:

- Check the oil on oil-lubricated units.
- Check the grease-lubricated bearings for saponification. This condition is usually caused by the infiltration of water or other fluid. Saponification gives the grease a whitish color. If this condition occurs, then wash out the bearings with a clean industrial solvent and replace the grease with the proper type as recommended.

### Six-month inspections

Perform these tasks every six months:

- Check the packing and replace if necessary. Use the grade recommended. Make sure the seal cages are centered in the stuffing box at the entrance of the stuffing box piping connection.
- Take vibration readings on the bearing housings. Compare the readings with the last set of readings to check for possible pump component failure.
- Check the shaft or shaft sleeve for scoring. Scoring accelerates packing wear.
- Check the alignment of the pump and driver. Shim the units if necessary. If misalignment reoccurs frequently, then inspect the entire piping system. Unbolt the piping at the suction and discharge flanges to see if it springs away, which indicates strain on the casing. Inspect all piping supports for soundness and effective support of load. Correct as necessary.

### Annual inspections

Perform these inspections one time each year:

- Remove the upper half of the casing. Inspect the pump thoroughly for wear. Order replacement parts if necessary.
- Check the wear ring clearances. Replace the wear rings when clearances become three times their normal clearance or when you observe a significant decrease in discharge pressure for the same flow rate.
- Remove any deposit or scaling.
- Clean out the stuffing box piping.
- Measure the total dynamic suction and discharge head in order to test pump performance and pipe condition. Record the figures and compare them with the

figures of the last test. This is especially important where the pumped liquid tends to form a deposit on internal surfaces.

- Inspect foot valves and check valves. A faulty foot or check valve will cause poor performance. The check valve safeguards against water hammer when the pump stops.

## 6.2 Flood-damaged pumps

If the pump is properly sealed at all joints and connected to both suction and discharge, then it will exclude outside liquid. Therefore, it is only necessary to service the bearings, stuffing box, and coupling after flood damage.

Perform the following service on a centrifugal pump after a flooded condition:

- Dismantle the frame, and then inspect the bearings for any rusted or badly worn surfaces. Clean as necessary. If the bearings are free from rust and wear, then reassemble and relubricate them with one of the recommended lubricants. Depending on the length of time the pump has remained in the flooded area, it is unlikely that bearing replacement is necessary. Only replace the bearings if rust or worn surfaces appear.
- Inspect the stuffing box and clean out any foreign matter that will clog the box. Replace packing that appears to be worn or no longer regulates leakage properly. Clean and thoroughly flush mechanical seals.
- Dismantle and thoroughly clean the couplings. Lubricate the couplings where required with one of the lubricants recommended by the coupling manufacturer.

## 6.3 Bearing maintenance

### Bearing lubrication schedule

Type of bearing	First lubrication, assembled pumps and replacement bearing frames	First lubrication, replacement bearings	Lubrication interval, pump, polyurea-based grease, operating hours
Grease-lubricated bearings	Not applicable, lubricated before shipment	Hand pack bearings before pressing on the shaft. After bearing frame assembly, follow relube instructions to lube bearings.	<ul style="list-style-type: none"> <li>• 3600 hours, 2 pole</li> <li>• 7200 hours, 4 pole</li> <li>• 50% for severe conditions: dirty, wet and/or above 100°F (38°C) ambient</li> <li>• 50% for bearing frame temperature above 180°F (82°C)</li> <li>• 75% for lithium-based grease</li> </ul>

### 6.3.1 Regrease the grease-lubricated bearings

It is important to lubricate pumps and motors that require regreasing with the proper grease. See the motor service instructions and nameplate for motor regreasing information. Pumps are to be regreased using the grease types listed below or approved equal. Always keep pump and motor properly lubricated.

#### NOTICE:

Make sure that the grease container, the greasing device, and the fittings are clean. Failure to do this can result in impurities entering the bearing housing when you regrease the bearings.

1. With fully enclosed coupling guards, regrease pump while pump is running.
  - a) With old style open ended guards, stop pump, re-grease, and hand turn shaft before re-starting.
2. Wipe dirt from the grease fittings before greasing.

3. Fill both of the grease cavities through the fittings with the recommended grease. Stop when grease leaks out at shaft.
4. If needed, stop pump and wipe off excess grease.
5. Restart pump.

The bearing temperature usually rises after you regrease due to an excess supply of grease. Temperatures return to normal in about two to four operating hours as the pump runs and purges the excess grease from the bearings. Maximum normal bearing housing temperature for polyurea-based grease is 225°F (107°C) and for lithium-based grease 180°F (82°C).

### 6.3.2 Lubricating grease requirements

#### NOTICE:

- Never mix greases of different consistencies (NLGI 1 or 3 with NLGI 2) or with different thickeners. For example, never mix a lithium-based grease with a polyurea-based grease. This can result in decreased performance.
- Remove the bearings and old grease if you need to change the grease type or consistency. Failure to do so can result in equipment damage or decreased performance.

#### Specifications – grease types

Polyurea-based greases	Lithium-based greases, NLGI 2
Pumps built <b>on or after Dec 1, 2014</b> use Polyurea-based greases. See <b>date code label</b> and <b>lubrication label</b> on pump or bearing frame <b>indicating polyurea-base grease</b>	Pumps built <b>before Dec 1, 2014</b> were built with Lithium-based greases, NLGI 2, and do <b>not</b> have lubrication label on pump or bearing frame indicating pump grease type
ExxonMobil Polyrex™ EM	Shell Gadus® S2 V100 2 (was Alvania RL 2)
Chevron SRI NLGI 2	Chevron Multifak® EP 2
Shell Gadus® S5 T100 2	ExxonMobil Unirex™ N2

## 6.4 Shaft-seal maintenance

### 6.4.1 Mechanical seal maintenance

Keep in mind the following general rules regarding mechanical seal maintenance. Refer to the instructions provided by the seal manufacturer for detailed information.

- Mechanical seals are precision products that must be treated with care. Use special care when handling seals. Make sure that oil and parts are clean in order to prevent scratching the finely lapped sealing faces. Even light scratches on these faces can result in leaky seals.
- Mechanical seals typically require no adjustment or maintenance except for routine replacement of worn or broken parts.
- A used mechanical seal should not be put back into service unless the sealing faces have been replaced or relapped. Relapping is practical only for seals that are 2 in. (5.1 cm) or larger.

For optimum seal life, always follow these precautions:

- Keep the seal faces as clean as possible.
- Keep the seal as cool as possible.
- Make sure the seal always has proper lubrication.
- If the seal is lubricated with filtered fluid, then clean the filter frequently.

## 6.4.2 Packed stuffing box maintenance

Check or instruction	Explanation/comment
When starting a pump with fiber packing for the first time, make sure that the packing is slightly loose without causing an air leak. As the pump runs in, gradually tighten the gland bolts evenly.	Never draw the gland to the point where the packing is compressed too tightly and no leakage occurs. This will burn the packing, score the shaft sleeve, and prevent circulation of the liquid that cools the packing.
Turn the rotating element by hand.	The stuffing box is improperly packed or adjusted if friction in the box prevents turning the rotating element by hand. A properly operated stuffing box runs lukewarm with a slow drip of sealing liquid.
After the pump has been in operation for some time and the packing is completely run in, check that the stuffing box leaks at the rate of 40–60 drops per minute.	This indicates proper packing, shaft sleeve lubrication, and cooling. <b>NOTICE:</b> Eccentricity of the shaft or sleeve through the packing can result in excess leakage. Make sure that the parts are properly centered.
Check the packing frequently and replace as service indicates.	Six months is a reasonable expected life, depending on operating conditions. Use a packing tool in order to remove all old packing from the stuffing box. Never reuse old packing or add new rings to old packing. Clean the stuffing box thoroughly before you install new packing.
Check the condition of the shaft or sleeve for possible scoring or eccentricity and make replacements as necessary.	–
When placing new, non-asbestos packing into the stuffing box, open the molded rings sideways and push the joints into the stuffing box first. Then install the rings one at a time, making sure to seat each ring firmly. Stagger the joints at a 90° rotation from each preceding joint.	–

## 6.5 Cleaning without dismantling the pump

A short section of pipe so designed that it can be readily dropped out of the line can be installed adjacent to the suction flange. With this arrangement, any matter clogging the impeller is accessible by removing the pipe section.

If the pump cannot be freed of clogging after the above methods have been tried, dismantle the unit as previously described to locate the trouble.

## 6.6 Disassembly

### 6.6.1 Disassembly precautions

This manual clearly identifies accepted methods for disassembling units. These methods must be adhered to.



#### WARNING:

- Make sure that the pump is isolated from the system and that pressure is relieved before you disassemble the pump, remove plugs, open vent or drain valves, or disconnect the piping.
- Always disconnect and lock out power to the driver before you perform any installation or maintenance tasks. Failure to disconnect and lock out driver power will result in serious physical injury.
- Crush hazard. The unit and the components can be heavy. Use proper lifting methods and wear steel-toed shoes at all times.

**NOTICE:**

Make sure that all replacement parts are available before you disassemble the pump for overhaul.

**6.6.2 Drain the pump****CAUTION:**

- Allow all system and pump components to cool before you handle them to prevent physical injury.

1. Close the isolation valves on the suction and discharge sides of the pump.  
You must drain the system if no valves are installed.
2. Open the drain valve.  
Do not proceed until liquid stops coming out of the drain valve. If liquid continues to flow from the drain valve, the isolation valves are not sealing properly and you must repair them before you proceed.
3. Leave the drain valve open and remove the drain plug located on the bottom of the pump housing.  
Do not reinstall the plug or close the drain valve until the reassembly is complete.
4. Drain the liquid from the piping and flush the pump if it is necessary.
5. Disconnect all auxiliary piping and tubing.

**6.6.3 Remove the hex coupling guard**

1. Remove the two capscrews that hold the outer (motor side) coupling guard to the support brackets.
2. Spread the outer guard apart and pull it off the inner guard.  
Do not spread the outer and inner guards more than necessary to remove the guard. It could alter their fit and appearance.
3. Remove the capscrew that holds the inner guard to the support bracket.
4. Spread the inner guard apart and pull it over the coupling.

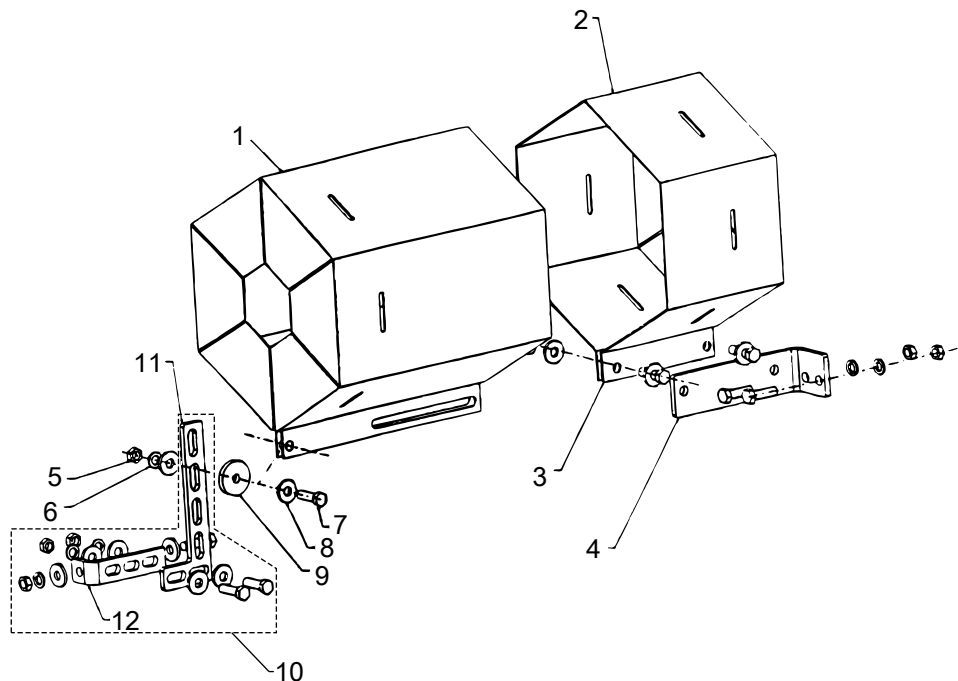

1. Outer guard
2. Inner guard
3. Attach the support bracket inline with the bolt
4. Support bracket
5. Nut
6. Lockwasher
7. Capscrew
8. Flat washer
9. Spacer washer
10. Option used instead of the spacer where overall guard length exceeds 12 in. (30 cm) or the guard width is over 10 in. (25 cm) across the flats
11. Locate the support arm between the outer guard ends. Align the arm with holes in the outer guard and holes in the saddle bracket.
12. Motor saddle bracket attached to the motor saddle

Figure 19: Hex guard exploded view for typical installation

#### 6.6.4 Disassemble the pump with mechanical seal on the shaft

1. Close valves on suction and discharge sides of pump.  
If no valves have been installed, it will be necessary to drain the pump.
2. Remove coupling guard and disconnect coupling.  
Refer to instructions on how to remove the hex coupling guard.  
a) Remove external tubing, if supplied.
3. Loosen but do not remove main joint capscrews (2-904-1 and 2-904-2). Insert a screwdriver or pry bar into the slots between the upper and lower casing halves – separate joint.
4. Remove all casing main joint capscrews and dowels (2-916-1). Lift off the upper casing half.
5. Tap the stuffing boxes with a soft-headed hammer to break the seal between the stuffing box and lower casing half, and lift the rotating element out of the lower casing.  
A spare rotating element can be installed at this point.

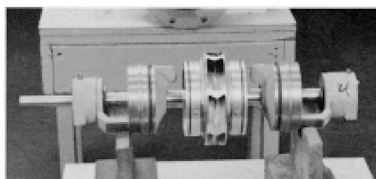

6. Remove the four capscrews (3-904-9) from each bearing housing (3-025-3 and 3-025-4) and remove the bearing housings from the shaft.
7. Remove the snap ring (3-915-4) (or locknut and lockwasher on pumps built after 1991) from the outboard end of the shaft and, using a puller, remove the bearing (3-026-4) from the shaft. Remove the drive end bearing in the same manner.  
Snap ring is not used on drive end bearings.  
**IMPORTANT:** Do not reuse the ball bearings.
8. Slide stuffing boxes (3-073-9) off of the shaft, working deflector ring (3-136-9) off the shaft at the same time.

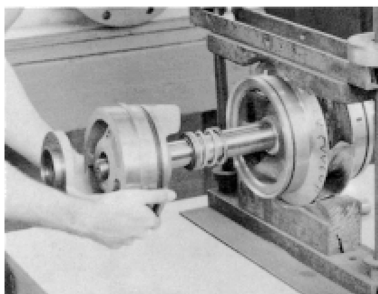

9. Drive oil seal (3-177-9) from the stuffing box.
10. Drive mechanical seal seat (3-401-0) from the stuffing box.

11. Remove the two casing rings (3-003-9) from the impeller (4-002-0) and remove o-ring (3-914-9) and locating pin (3-943-9) from each casing ring.

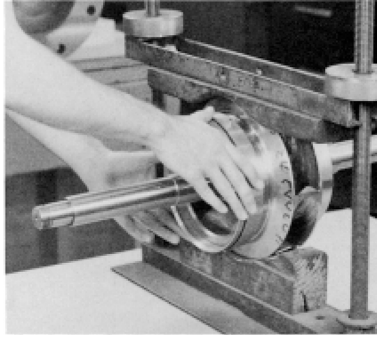

12. Remove the mechanical seal head (3-402-0) from the pump shaft.
13. Remove the impeller retaining ring (3-915-1) with retaining ring pliers. Heat the impeller hub on both ends to 350°F maximum, and pull or push the impeller from the shaft.

For impellers with replaceable rings, remove the rings by cutting rings with a cold chisel.

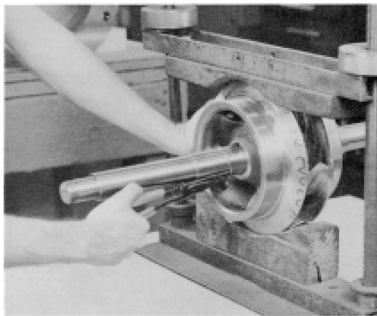

### 6.6.5 Disassemble the pump with mechanical seals on shaft sleeve

1. Close valves on suction and discharge sides of the pump.  
If no valves have been installed, it will be necessary to drain the system.
2. Remove coupling guard and disconnect coupling.  
Refer to instructions on how to remove the hex coupling guard.
  - a) Remove external tubing (1-939-9), if supplied.
3. Loosen but do not remove main joint capscrews (2-904-1 and 2-904-2). Insert a screwdriver or pry bar into the slots between the upper and lower casing halves – separate joint.
4. Remove all casing main joint capscrews and dowels (2-916-1). Lift off the upper casing half.
5. Tap the stuffing boxes with a soft-headed hammer to break the seal between the stuffing box and lower casing half, and lift the rotating element out of the lower casing.  
A spare rotating element can be installed at this point.

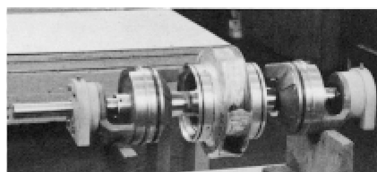

6. Remove the four capscrews (3-904-9) from each bearing housing (3-025-3 and 3-025-4) and remove the bearing housings from the shaft.

7. Remove the snap ring (3-915-4) (or locknut and lockwasher on pumps built after 1991) from the outboard end of the shaft and, using a puller, remove the bearing (3-026-4) from the shaft. Remove the drive end bearing in the same manner.

Snap ring is not used on drive end bearings.

**IMPORTANT:** Do not reuse the ball bearings.

8. Slide stuffing boxes (3-073-9) off of the shaft, working deflector ring (3-136-9) off the shaft at the same time.

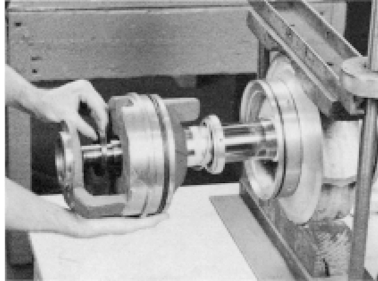

9. Drive oil seal (3-177-9) from the stuffing box.
10. Drive mechanical seal seat (3-401-0) from the stuffing box.
11. Remove the two casing rings (3-003-9) from the impeller (4-002-0) and remove o-ring (3-914-2) and locating pin (3-943-9) from each casing ring.

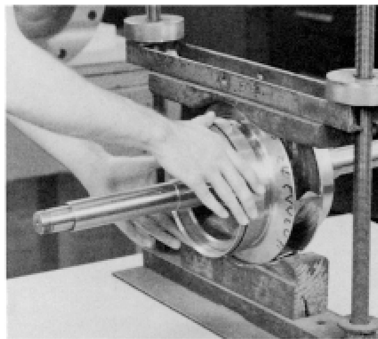

12. Remove mechanical seal head 3-402-0) from the pump shaft. If set collar (3-421-9) must be removed, scribe a line on shaft sleeve (3-009-9) flush with end of seal.
13. Loosen set screw (3-902-3) in shaft nut (3-015-9) and remove the nut. On pumps built after 1991, remove o-rings from counterbore in shaft sleeves.
14. Remove shaft sleeve (3-009-9) and impeller (4-002-0).  
NOTE: Apply heat uniformly to the shaft sleeve to loosen the sealant between the shaft and sleeve. DO NOT HEAT ABOVE 300°F. To further assist in removing the sleeve, hold the shaft vertically and drop it on a block of wood. The impeller weight should force both the impeller and sleeve from the shaft.
15. Follow steps 12, 13, and 14 for other seal, shaft sleeve, and nut removal.  
NOTE: For impellers with replaceable rings – remove the rings (4-004-9) by cutting the rings with a cold chisel.

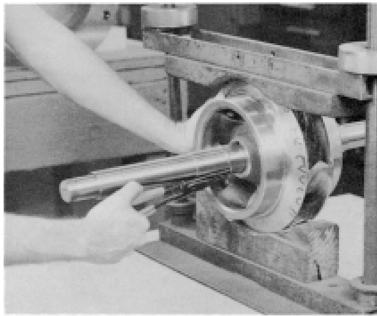

16. Remove the impeller key (3-911-1).

### 6.6.6 Disassemble the pump with packing

1. Close valves on suction and discharge sides of pump.  
If valves have been installed, it will be necessary to drain the system.
2. Remove the coupling guard and disconnect coupling.  
Refer to instructions on how to remove the hex coupling guard.
  - a) Remove external tubing (1-939-9), if supplied.
3. Loosen but do not remove main joint capscrews (2-904-1 and 2-904-2). Insert a screwdriver or pry bar into the slots between the upper and lower casing halves – separate joint.
4. Remove all casing main joint capscrews and dowels (2-916-1). Lift off the upper casing half.
5. Tap the stuffing boxes with a soft-headed hammer to break the seal between the stuffing box and lower casing half, and lift the rotating element out of the lower casing.  
A spare rotating element can be installed at this point.

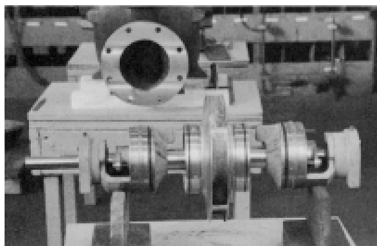

6. Remove the four capscrews (3-904-9) from each bearing housing (3-025-3 and 3-025-4) and remove the bearing housings from the shaft.
7. Remove the snap ring (3-915-4) (or locknut and lockwasher on pumps built after 1991) from the outboard end of the shaft and, using a puller, remove the bearing (3-026-4) from the shaft. Remove the drive end bearing in the same manner.  
Snap ring is not used on drive end bearings.  
**IMPORTANT:** Do not reuse the ball bearings.
8. Slide stuffing boxes (3-073-9) off of the shaft, working deflector ring (3-136-9) off the shaft at the same time.

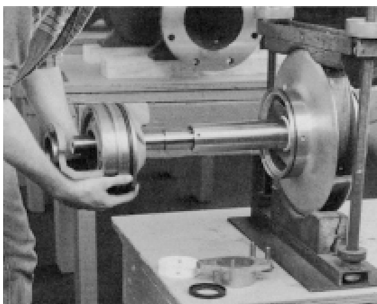

9. Drive oil seal (3-177-9) from the stuffing box.

10. Remove the two gland bolts, gland halves and packing from each stuffing box.
11. Remove two casing rings (3-003-9) from the impeller (4-002-0) and remove o-ring (3-914-2) and locating pin (3-943-9) from each casing ring.
12. Loosen set screw (3-902-3) in shaft nut (3-015-9) and remove the nut. On pumps built after 1991, remove o-rings from counterbore in shaft sleeves.
13. Remove shaft sleeve (3-009-9) and impeller (4-002-0).

NOTE: Apply heat uniformly to the shaft sleeve to loosen the sealant between the shaft and sleeve. DO NOT HEAT ABOVE 300°F. To further assist in removing the sleeve, hold the shaft vertically and drop it on a block of wood. The impeller weight should force both the impeller and sleeve from the shaft.

14. Follow steps 12 and 13 for other shaft sleeve and nut removal.

NOTE: For impellers with replaceable rings – remove the rings (4-004-9) by cutting the rings with a cold chisel.

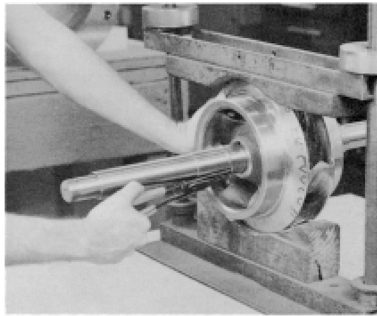

15. Remove impeller key (3-911-1).

## 6.7 Pre-assembly inspections

### Guidelines

Before you assemble the pump parts, make sure you follow these guidelines:

- Inspect the pump parts according to the information in these pre-assembly topics before you reassemble your pump. Replace any part that does not meet the required criteria.
- Make sure that the parts are clean. Clean the pump parts in solvent in order to remove oil, grease, and dirt.

#### NOTICE:

Protect machined surfaces while you clean the parts. Failure to do so may result in equipment damage.

### 6.7.1 Replacement guidelines

#### Impeller replacement

This table shows the criteria for replacing the impeller:

Impeller parts	When to replace
Impeller vanes	<ul style="list-style-type: none"> <li>• When grooved deeper than 1/16 in. (1.6 mm), or</li> <li>• When worn evenly more than 1/32 in. (0.8 mm)</li> </ul>
Vane edges	When you see cracks, pitting, or corrosion damage

#### Gaskets, O-rings, and seats replacement

- Replace all gaskets and O-rings at each overhaul and disassembly.
- Inspect the seats. They must be smooth and free of physical defects.
- Replace parts if the seats are defective.

## 6.7.2 Shaft and sleeve inspection

### Inspection criteria

Inspect the shaft and sleeve according to this criteria:

- Thoroughly clean the shaft and sleeve.
- Thoroughly clean the coverplate seal cavity.
- Inspect the surface for damage such as pitting, corrosion, nicks, and scratches.

Replace these parts if they are damaged.

## 6.8 Dimensions

### Pump with mechanical seal on the shaft



Figure 20: Cross section

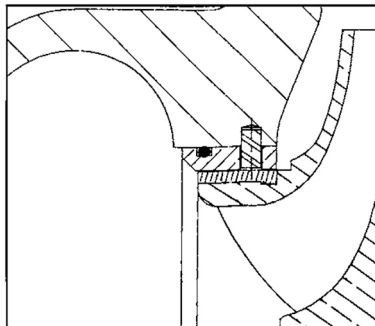

Figure 21: Impeller wear ring

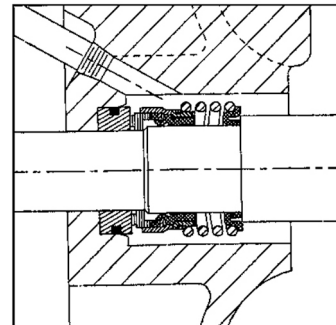

Figure 22: Balanced mechanical seal

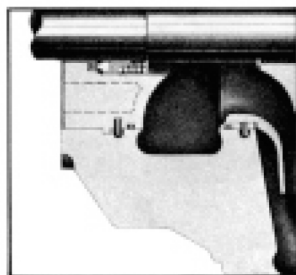

Figure 23: Dowel pin location at parting line

## Pump with mechanical seals on the shaft sleeves

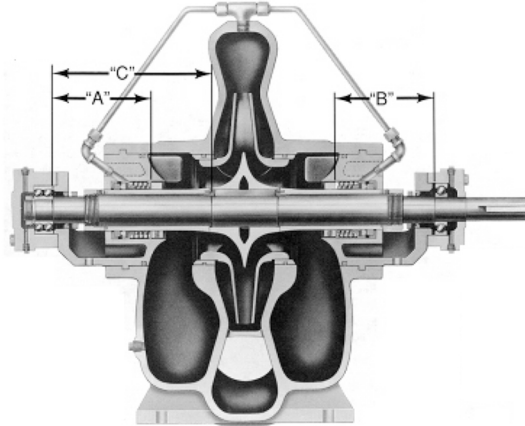

Figure 24: Cross section

Setting Dimensions							
Pump size	Type 1 Mechanical seal		Type 21 Mechanical seal		Type 1B Mechanical seal		Impeller locating dimension
	"A"	"B"	"A"	"B"	"A"	"B"	"C"
3x2x11	6.62	6.75	6.00	6.12	7.00	7.12	8.755
6x4x10A	6.62	6.75	6.00	6.12	7.00	7.12	9.315
6x4x10	7.56	7.75	6.94	7.12	8.06	8.25	10.625
6x4x12A	7.56	7.75	6.94	7.12	8.06	8.25	10.625
6x4x12	6.62	6.75	6.00	6.12	7.00	7.12	9.755
6x4x14	6.62	6.75	6.00	6.12	7.00	7.12	9.755
8x6x12	6.63	6.75	6.00	6.12	7.00	7.12	9.755
8x6x13	7.31	7.50	6.69	6.88	7.81	8.00	10.625
8x6x17	7.31	7.50	6.69	6.88	7.81	8.00	10.625
8x8x12	7.31	7.50	6.69	6.88	7.81	8.00	10.625
8x8x17	7.88	8.00	7.06	7.18	8.25	8.36	11.495
10x8x12	7.88	8.00	7.06	7.18	8.25	8.36	11.495
10x8x17	7.88	8.00	7.06	7.18	8.25	8.36	11.495
10x10x12	7.88	8.00	7.06	7.18	8.25	8.36	12.995
12x10x12	7.88	8.00	7.06	7.18	8.25	8.36	12.995
12x10x14	7.88	8.00	7.06	7.18	8.25	8.36	12.995
12x10x17	7.88	8.00	7.06	7.18	8.25	8.36	12.995

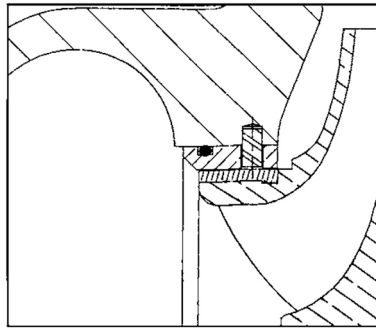

Figure 25: Impeller wear ring

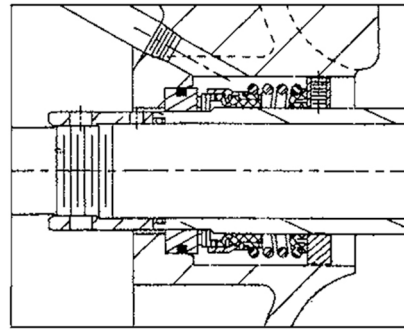

Figure 26: Balanced mechanical seal on sleeve – optional extra

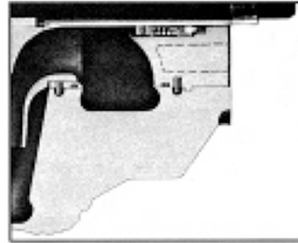

Figure 27: Dowel pin location at parting line

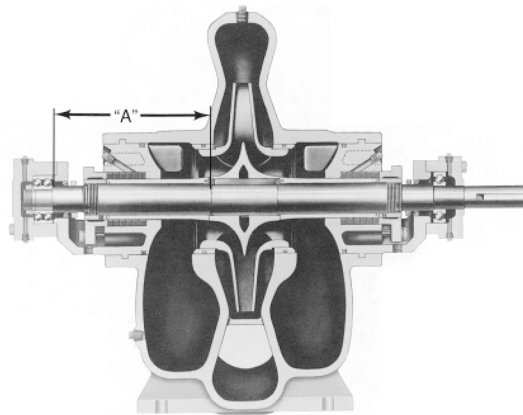

Figure 28: Cross section

Pump size	Dimension "A"	Packing size
3x2x11	8.755	3/8
6x4x9	9.312	
6x4x10A	9.312	
6x4x10	10.625	1/2
6x4x11	10.75	3/8
6x4x12A	10.625	1/2
6x4x12	9.755	3/8
6x4x14		
6x6x9	9.312	1/2
8x6x10	10.625	
8x6x12	9.775	

Pump size	Dimension "A"	Packing size
8x6x12M	10.625	1/2
8x6x13		
8x6x17		
8x6x18		
8x8x12		
8x8x17		
10x8x12	11.495	
10x8x17		
10x8x20		
10x10x12	12.995	
12x10x12		
12x10x14	11.495	
12x10x17		

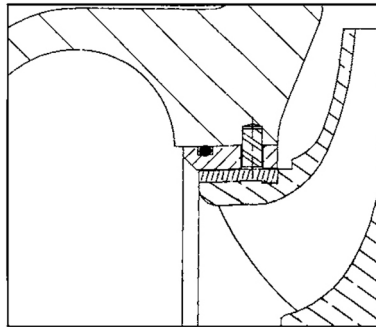

Figure 29: Impeller wear ring

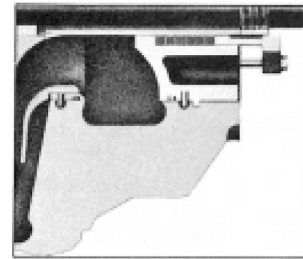

Figure 30: Dowel pin location at parting line

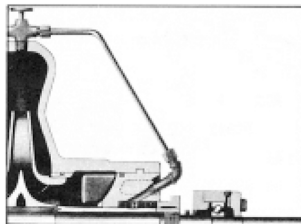

Figure 31: Optional – internal piping with seal cage

## 6.9 Reassembly

### 6.9.1 Reassemble the pump with mechanical seal on the shaft

All bearings, O-rings, seals, and gaskets should be replaced with new parts during assembly. All reusable parts should be cleaned of all foreign matter before reassembling. The main casing joint gasket should be made using the upper half as a template. Lay the gasket material on the casing joint and mark it by pressing it against the edges of the casing. Trim the gasket so that it is flush with the inside edges of the casing.

1. Assemble the impeller key (3-911-1) in the shaft key slot.
2. Check the impeller (4-002-0) and casing to determine the correct relationship. Heat the impeller evenly to 300°F maximum to expand the bore.  
For impellers with replaceable rings, heat each new ring (4-004-9) and slide it onto the impeller. Hold the rings against the impeller shoulder until they cool.
3. Push the heated impeller on the shaft (3-007-0) against the shaft shoulder. Install retaining ring (3-915-1).

Impeller may be pressed onto the shaft if a suitable press is available.

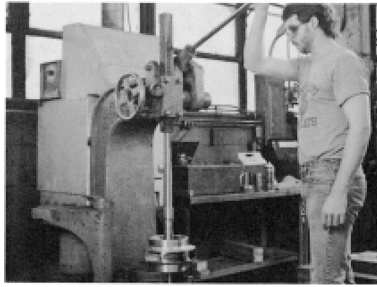

4. Lubricate and roll an O-ring (3-914-2) on each casing ring (3-003-9) and slide the casing rings onto the impeller.
5. Thoroughly clean the stuffing boxes (3-073-9) to prevent dirt from entering the seal during start-up.
6. Press the stationary seats (3-401-0) of the mechanical seals into both stuffing boxes. Lightly lubricate the stuffing box bore to ease assembly.



7. Press a new oil seal (3-177-9) into each stuffing box.  
Seal lip must point away from the bearing (3-026-4).
8. Lubricate and roll O-ring (3-914-1) into the groove in each stuffing box.  
**IMPORTANT:** Steps 9 through 14 must be completed within 10-12 minutes to assure proper placements of the mechanical seal.
9. Lightly coat the outboard end of the shaft with soapy water or vegetable oil and slide the mechanical seal head (3-402-0) onto the shaft.

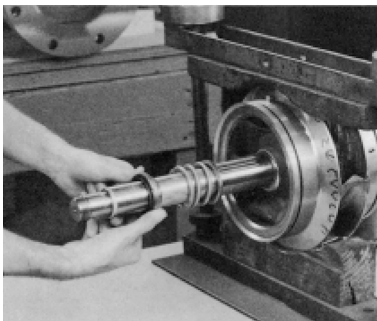

10. Slide each stuffing box onto the shaft so that the shaft end extends through the mechanical seal area, but does not enter the oil seal. This will permit installation of the deflector (3-136-9).
11. Slide the deflector over the shaft end; then push the shaft end through the oil seal and slide stuffing box fully onto the shaft. **DO NOT COMPRESS THE SEAL SPRING AT THIS TIME.**
12. Heat the ball bearing (3-026-4), using either dry heat or a 10 to 15% soluble oil and water solution.
13. Using gloves, press the heated bearing onto the shaft against the shaft shoulder.

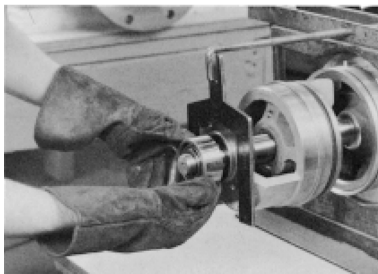

14. Install the snap ring (3-915-4) (or locknut and lockwasher) on the outboard end of the shaft.
15. Cool the bearing to room temperature and coat both sides with two or three oz of recommended grease.
16. Coat the inside of the bearing housing (3-025-4) with grease and slide into place over bearing. Attach the bearing housing to the stuffing box with four capscrews (3-904-9).
17. Repeat steps 9 through 13, 15 and 16, including IMPORTANT NOTE in step 8, for the inboard side of rotating element.

NOTE: A snap ring is not installed on the inboard end of the shaft.

18. Set the rotating element in the pump casing. Locate both stuffing box tongues in their respective casing grooves. Locate the pins (3-943-9) in stuffing box and wear rings in their respective slots at the casing parting surface. Correct and excessive O-ring buckling.

NOTE: Do not cut or damage O-rings when lowering the rotating element into position. When all four pins are correctly located, there will be some casing ring looseness.

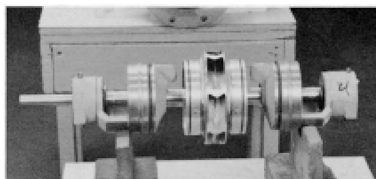

19. Install a new 1/64 in thick gasket with a light coat of commercial cup grease on both gasket surfaces.  
IMPORTANT: Align the inner edge of the gasket with the stuffing box O-rings.
20. Lower the upper half casing (2-001-7) into place and install casing joint bolts (2-904-1).  
IMPORTANT: When installing upper half casing, assure that O-rings are not cut or pinched.

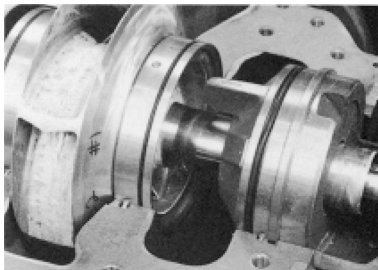

21. Insert tapered casing joint dowels (2-916-1), and drive them home.
22. Tighten the casing joint bolts to the following torque values: 140 ft-lb minimum for 5/8"-11 hex head capscrews (Grade 5); 350 ft-lb minimum for 7/8"-9 Ferry Cap Counter screws (Grade 8).

The bolt torque pattern is shown in the following figure.

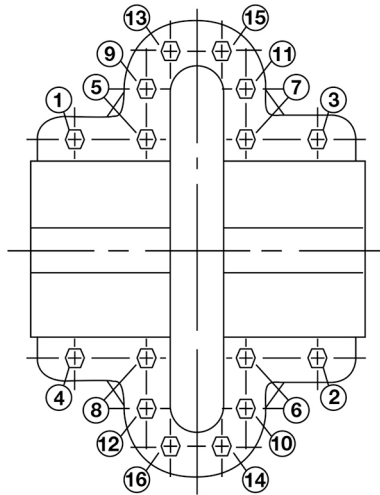

23. Rotate the shaft by hand to assure that it turns smoothly and is free from rubbing or binding.
24. Install the coupling and align. Replace the coupling guard. Refer to Install the hex coupling guard instructions.

### 6.9.2 Reassemble the pump with the mechanical seals on the shaft sleeve

All bearings, O-rings, seals, and gaskets should be replaced with new parts during assembly. All reusable parts should be cleaned of all foreign matter before reassembling. The main casing joint gasket should be made using the upper half as a template. Lay the gasket material on the casing joint and mark it by pressing it against the edges of the casing. Trim the gasket so that it is flush with the inside edges of the casing.

1. Assemble the impeller key (3-911-1) in the shaft key slot.
2. Apply 1/2" wide bead of Loctite or Permatex sealant to outboard end of shaft – 3" from the impeller hub.
3. Slide sleeve (3-009-9) onto shaft, rotating the sleeve to evenly distribute the sealant applied in step 3. On pumps built after 1991, install sleeve O-ring onto the shaft, into the sleeve counterbore.

**IMPORTANT:** The pin in sleeve must seat in the impeller keyslot for proper sleeve alignment.

4. Repeat steps 3 through 5 for the inboard shaft sleeve.
5. Assemble O-rings (3-914-2) in each casing ring (3-003-9) and slide ring onto the impeller.
6. Press a new oil seal (3-177-9) into each stuffing box (3-073-9).

**NOTE:** Seal lip must point away from the bearing.



7. Lubricate and roll O-ring (3-914-1) into the groove in each stuffing box.
8. Press stationary seats (3-401-0) of the mechanical seals into both stuffing boxes. Lightly lubricate the stuffing box bore to ease assembly.

9. Obtain the set collar (3-421-9) locating dimension from the table and scribe the dimension on the shaft sleeves. Install set collar on sleeve per dimension.  
**IMPORTANT:** Steps 12 through 16 must be completed within 10-12 minutes to assure proper placement of the mechanical seal.
10. Lightly coat the outboard end of the shaft sleeve with soapy water or vegetable oil and slide the mechanical seal head (3-402-0) onto the shaft sleeve against set collar.

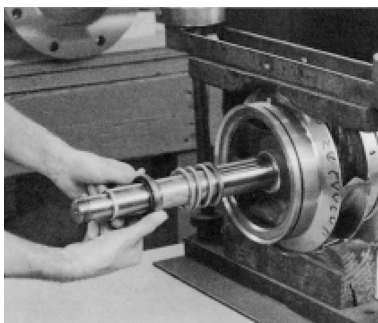

11. Slide each stuffing box onto the shaft so that the shaft end extends through the mechanical seal area, but does not enter the oil seal. This will permit installation of the deflector (3-136-9).
12. Slide the deflector over the shaft end; then push the shaft end through the oil seal and slide stuffing box fully onto the shaft. **DO NOT COMPRESS THE SEAL SPRING AT THIS TIME.**
13. Heat ball bearing (3-026-4), using either dry heat or a 10-15% soluble oil and water solution.  
**IMPORTANT:** Do not exceed 275°F.
14. Using gloves, press the heated bearing onto the shaft against the shaft shoulder.

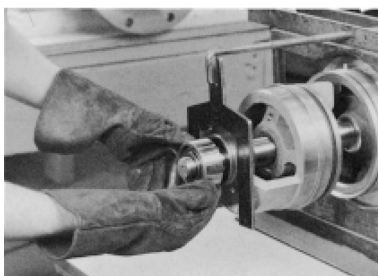

15. Install the locknut and lockwasher or snap ring (3-915-4) on the outboard end of the shaft.
16. Cool the bearing to room temperature and coat both sides with two or three oz of recommended grease.
17. Coat the inside of the bearing housing (3-025-4) with grease and slide into place over bearing. Attach the bearing housing to the stuffing box with four capscrews (3-904-9).
18. Repeat steps 12 through 16, 18, and 19, including **IMPORTANT NOTE** in step 11, for inboard side of rotating element.  
**NOTE:** A snap ring is not installed on the inboard end of the shaft.
19. Set the rotating element in the pump casing. Locate both stuffing box tongues in their respective casing grooves. Locate the pins in stuffing box and wear rings in their respective slots at the casing parting surface. Correct and excessive O-ring buckling.  
**NOTE:** Do not cut or damage O-rings when lowering the rotating element into position. When all four pins are correctly located, there will be some casing ring looseness.

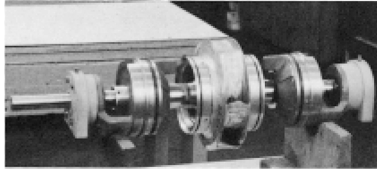

20. Install a new 1/64 in thick gasket with a light coat of commercial cup grease on both gasket surfaces.

**IMPORTANT:** Align the inner edge of the gasket with the stuffing box O-rings.

21. Lower the upper half casing (2-001-7) into place and install casing joint bolts (2-904-1 and -2).

**IMPORTANT:** When installing upper half casing, assure that O-rings are not cut or pinched.

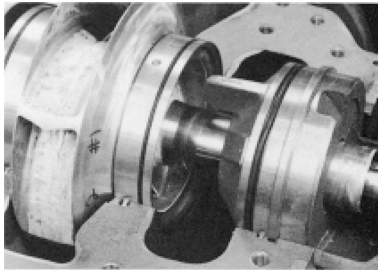

22. Insert tapered casing joint dowels (2-916-1), and drive them home.

23. Tighten the casing joint bolts to the following torque values: 140 ft-lb minimum for 5/8"-11 hex head capscrews (Grade 5); 350 ft-lb minimum for 7/8"-9 Ferry Cap Counterbor screws (Grade 8).

The bolt torque pattern is shown in the following figure.

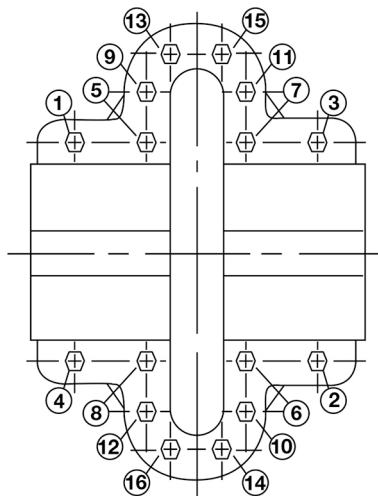

24. Rotate the shaft by hand to assure that it turns smoothly and is free from rubbing or binding.

25. Install the coupling and align. Replace the coupling guard. Refer to Install the hex coupling guard instructions.

### 6.9.3 Reassemble the pump with packing

All bearings, O-rings, seals, and gaskets should be replaced with new parts during assembly. All reusable parts should be cleaned of all foreign matter before reassembling. The main casing joint gasket should be made using the upper half as a template. Lay the gasket material on the casing joint and mark it by pressing it against the edges of the casing. Trim the gasket so that it is flush with the inside edges of the casing.

1. Assemble the impeller key (3-911-1) in the shaft key slot.
2. Check the impeller (4-002-0) and casing to determine the correct impeller rotation and locate the impeller on the shaft per dimension "A" given in table.  
NOTE: For impellers with replaceable rings, heat each new ring (4-004-9) and slide it onto the impeller. Hold the rings against the impeller shoulder until they cool.
3. Apply 1/2" wide bead of Loctite or Permatex sealant to outboard end of shaft – 3" from the impeller hub.
4. Slide sleeve (3-009-9) onto shaft, rotating the sleeve to evenly distribute the sealant that is applied in step 3. On pumps that are built after 1991, install sleeve O-ring onto the shaft, into the sleeve counterbore.  
IMPORTANT: The pin in sleeve must seat in the impeller keyslot for proper sleeve alignment.
5. Assemble the shaft sleeve nut (3-015-9).  
IMPORTANT: Assure that dimension "C" is maintained. Drill a shallow recess in the shaft through the set screw hold in the nut. Lock the nut in position with the set screw (3-902-3).

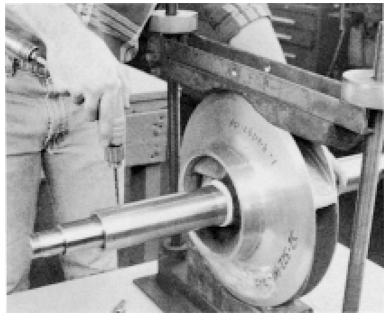

6. Repeat steps 3 through 5 for the inboard shaft sleeve.
7. Assemble O-rings (3-914-2) in each casing ring (3-003-9) and slide ring onto the impeller.



8. Press a new oil seal (3-177-9) into each stuffing box (3-073-9).  
NOTE: Seal lip must point away from the bearing.
9. Lubricate and roll O-ring (3-914-1) into the groove in each stuffing box.
10. Slide each stuffing box onto the shaft but do not enter the oil seal. This will permit installation of the deflector (1-136-9).
11. Slide the deflector over the shaft end; then push the shaft end through the oil seal and slide the stuffing box fully onto the shaft.
12. Heat ball bearing (3-026-4), using either dry heat or a 10-15% soluble oil and water solution.  
IMPORTANT: Do not exceed 275°F.
13. Using gloves, press the heated bearing onto the shaft against the shaft shoulder.

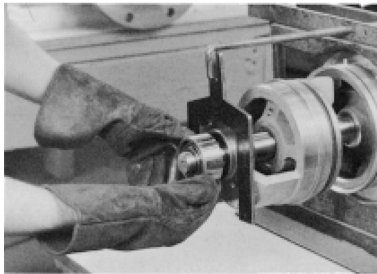

14. Install the locknut and lockwasher or snap ring (3-915-4) on the outboard end of the shaft.
15. Cool the bearing to room temperature and coat both sides with 2 or 3 oz of recommended grease.
16. Coat the inside of the bearing housing (3-025-4) with grease and slide into place over bearing. Attach the bearing housing to the stuffing box with four capscrews (3-904-9).
17. Repeat the steps for the inboard side of rotating element.

NOTE: A snap ring is not installed on the inboard end of the shaft.

18. Set the rotating element in the pump casing. Locate both stuffing box tongues in their respective casing grooves. Locate the pins in stuffing box and wear rings in their respective slots at the casing parting surface. Correct and excessive O-ring buckling.

NOTE: Do not cut or damage O-rings when lowering the rotating element into position. When all four pins are correctly located, there will be some casing ring looseness.

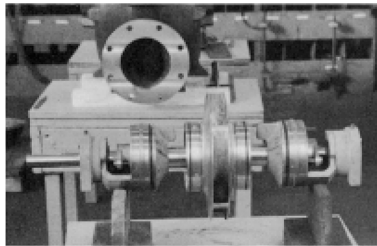

19. Install a new 1/64 in thick gasket with a light coat of commercial cup grease on both gasket surfaces.
20. Lower the upper half casing (2-001-7) into place and install casing joint bolts (2-904-1 and -2).

IMPORTANT: When installing upper half casing, assure that O-rings are not cut or pinched.

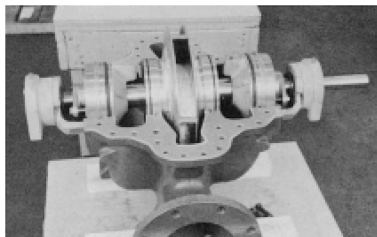

21. Insert tapered casing joint dowels (2-916-1), and drive them home.
22. Tighten the casing joint bolts to the following torque values: 140 ft-lb minimum for 5/8"-11 hex head capscrews (Grade 5); 350 ft-lb minimum for 7/8"-9 Ferry Cap Counter screws (Grade 8).

The bolt torque pattern is shown in the following figure.

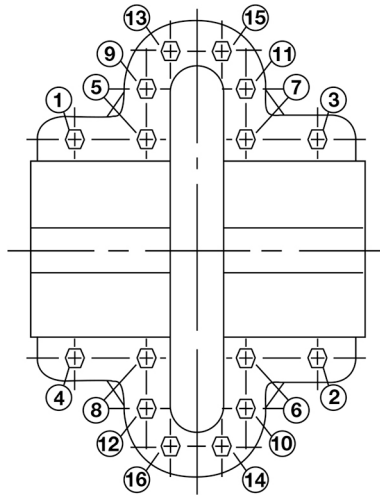

23. Rotate the shaft by hand to assure that it turns smoothly and is free from rubbing or binding.
24. Install the coupling and align. Replace the coupling guard. Refer to Install the hex coupling guard instructions.
25. Install 12 full rings of packing (6 per stuffing box) so that the ends butt, leaving no gap between the packing and the stuffing box.
26. Assemble the glands, washers, and bolts square with the stuffing box and pull tight. Then loosen the gland bolts to permit the packing to expand. Then retighten finger tight. Final adjustment of the gland bolts must be done with the pump running. Allow 30 minutes between adjustments. A good adjustment should allow approximately one drip per second.

#### 6.9.4 Install the hex coupling guard

1. Check coupler alignment before proceeding. Correct if necessary.
2. Slide the inner guard into the outer guard.
3. Spread the guards and place them over the coupling.  
Do not spread the inner and outer guards more than necessary for guard installation, as it can alter their fit and appearance.
4. Straddle the support bracket with the guards and install a capscrew through the hole in the support bracket and guard located closest to the pump.  
Do not tighten the capscrew.
5. Install the outer guard capscrews according to the directions in this table.

If...	Then...
The pump has a motor saddle support bracket	Ensure that the outer guard straddles the support arm and install the two remaining capscrews. Do not tighten the capscrews.
The pump does not have a motor saddle support bracket	Insert the spacer washer between the holes located closest to the motor in the outer guard and install the two remaining capscrews. Do not tighten the capscrews.

6. Position the outer guard so that there is less than 1/4 in. (0.64 cm) of exposed shaft.
7. Hold the guard in this position and tighten the three capscrews.
8. Open the isolation valves and inspect the pump for leaks.
9. Return the pump to service if it is not leaking.

## 6.9.5 Assembly references

### 6.9.5.1 Ordering parts

The pumps covered by this manual have been designed and built with certain replaceable wearing parts. The recommended inventory of spare parts depends upon the installation and the importance of continued operation.

For critical service requiring a minimum of "down time" a complete or "quick change" rotating element is recommended.

For normal service, with repairs to be made in the field, the following parts are recommended for stock.

- 1 set of bearings
- 1 set of wearing rings
- 1 set of gaskets, O-rings, and grease seals
- 2 mechanical seals (complete), or 2 sets of packing (if provided)
- 1 set of shaft sleeves



Parts should be ordered as far in advance of their use as possible since circumstances beyond the control of the company may reduce existing stock. Not all parts are stocked and must be manufactured for each order.

To facilitate rapid handling of your order for spare parts, be sure to include the following information:

1. Serial number of the pump.
2. Catalog number of the part.
3. Quantity of each part.
4. Name of the part.
5. Material desired. (Parts will be furnished in original materials unless specified as a material change. All material substitutions should be discussed with the factory.)

### 6.9.5.2 Screw torque values

Capscrew torque in ft-lb (Nm)

Capscrew type	Head marking	Capscrew diameter (in inches)								
		1/4	5/16	3/8	7/16	1/2	5/8	3/4	7/8	1
SAE grade 2		6 (8)	13 (18)	25 (34)	38 (52)	60 (81)	120 (163)	190 (258)	210 (285)	300 (407)
Brass and stainless steel	or 	4 (5)	10 (14)	17 (23)	27 (37)	42 (57)	83 (113)	130 (176)	200 (271)	300 (407)
SAE grade 5		10 (14)	20 (27)	35 (47)	60 (81)	90 (122)	180 (244)	325 (440)	525 (712)	800 (1085)

\*The M6 set screw has a rating of 10 N m.

### 6.9.5.3 Dealer servicing

If trouble occurs that cannot be rectified, contact your local sales and service representative and be prepared to provide this information:

1. Complete nameplate data of pump and motor
2. Suction and discharge pipe pressure gauge readings
3. Ampere draw of the motor
4. A sketch of the pump hook-up and piping

# 7 Troubleshooting

## 7.1 Operation troubleshooting

Between regular maintenance inspections, be alert for signs of motor or pump trouble. Correct any trouble immediately and avoid costly repair and shutdown.

Symptom	Cause	Remedy
No liquid delivered	Lack of prime	Fill pump and suction pipe completely with liquid.
	Loss of prime	Check for leaks in suction pipe joints and fittings; vent casing to remove accumulated air.
	Suction lift too high.	If no obstruction at inlet, check for pipe friction losses. Static lift may be too great. Measure with mercury column or vacuum gauge while pump operates. If static lift is too high, liquid to be pumped must be raised or pump lowered.
	Discharge head too high.	Check pipe friction losses. Large piping may correct condition. Check that valves are wide open.
	The motor speed is too low.	Check whether motor is directly across-the-line and receiving full voltage. Or frequency may be too low; motor may have an open phase.
	Wrong direction of rotation.	Check motor rotation with directional arrow on pump casing.
	Impeller completely plugged.	Dismantle pump and clean impeller.

Symptom	Cause	Remedy
Not enough liquid being delivered	Air leaks in suction piping	If liquid pumped is water or other non-explosive, and explosive gas or dust is not present, test flanges for leakage with flame or match, or by plugging inlet and putting line under pressure. A gauge will indicate a leak with a drop of pressure.
	The motor speed is too low.	Check whether motor is directly across-the-line and receiving full voltage. Or frequency may be too low; motor may have an open phase.
	Discharge head too high	Check pipe friction losses. Large piping may correct condition. Check that valves are wide open.
	Suction lift too high	If no obstruction at inlet, check for pipe friction losses. Static lift may be too great. Measure with mercury column or vacuum gauge while pump operates. If static lift is too high, liquid to be pumped must be raised or pump lowered.
	Impeller partially plugged	Dismantle pump and clean impeller.
	Cavitation; insufficient NPSH (depending on installation)	<ol style="list-style-type: none"> <li>1. Increase positive suction head on pump by lowering pump.</li> <li>2. Sub-cool suction piping at inlet to lower entering liquid temperature.</li> <li>3. Pressurization suction vessel.</li> </ol>
	Defective impeller.	Inspect impeller, bearings and shaft. Replace is damaged or vane sections badly eroded.
	Foot valve too small or partially obstructed.	Area through ports of valve should be at least as large as area of suction pipe – preferable 1½ times. If strainer is used, net clear area should be 3 to 4 times area of suction pipe.
	Suction inlet not immersed deep enough.	If inlet cannot be lowered, or if eddies through which air is sucked persist when it is lowered, chain a board to suction pipe. It will be drawn into eddies, smothering the vortex.
Too small impeller diameter. Probable cause if none of above)	Check with factory to see if a larger impeller can be used; otherwise, cut pipe losses or increase speed – or both, if needed. Be careful not to seriously overload drive.	

Symptom	Cause	Remedy
Not enough pressure	Mechanical defects	See "Defective impeller" and "Foot valve too small or partially obstructed".
	Obstruction in liquid passages.	Dismantle pump and inspect passages of impeller and casing. Remove obstruction.
	Air or gases in liquid. (Test in laboratory, reducing pressure on liquid to pressure in suction line. Watch for bubble formation.)	May be possible to over rate pump to point where it will provide adequate pressure despite condition. Better to provide gas separation chamber on suction line near pump, and periodically exhaust accumulated gas. See "Cavitation; insufficient NPSH".
	Too small impeller diameter. (Probable cause if none above.)	Check with factory to see if a larger impeller can be used; otherwise, cut pipe losses or increase speed – or both, if needed. Be careful not to seriously overload drive.
Pump operates for short time, then stops	Incomplete priming.	Free pump, piping and valves of all air. If high points in suction prevent this, they need correcting.
	Suction lift too high.	If no obstruction at inlet, check for pipe friction losses. Static lift may be too great. Measure with mercury column or vacuum gauge while pump operates. If static lift is too high, liquid to be pumped must be raised or pump lowered.
	Air leaks in suction piping.	If liquid pumped is water or other non-explosive, and explosive gas or dust is not present, test flanges for leakage with flame or match, or by plugging inlet and putting line under pressure. A gauge will indicate a leak with a drop of pressure.
	Air or gasses in liquid.	May be possible to over rate pump to point where it will provide adequate pressure despite condition. Better to provide gas separation chamber on suction line near pump, and periodically exhaust accumulated gas. See "Cavitation; insufficient NPSH".
Pump takes too much power	Head lower than rating; thereby pumping too much liquid.	Machine impeller's OD to size advised by factory.
	Cavitation	<ol style="list-style-type: none"> <li>1. Increase positive suction head on pump by lowering pump.</li> <li>2. Sub-cool suction piping at inlet to lower entering liquid temperature.</li> <li>3. Pressurization suction vessel.</li> </ol>
	Mechanical defects	See "Defective impeller" and "Foot valve too small or partially obstructed".

Symptom	Cause	Remedy
	Suction inlet not immersed enough.	If inlet cannot be lowered, or if eddies through which air is sucked persist when it is lowered, chain a board to suction pipe. It will be drawn into eddies, smothering the vortex.
	Liquid heavier (in either viscosity or specific gravity) than allowed for.	Use larger driver. Consult factory for recommended size. Test liquid for viscosity and specific gravity.
	Wrong direction of rotation.	Check motor rotation with directional arrow on pump casing.
	Casing distorted by excessive strains from suction or discharge piping.	Check alignment. Examine pump for friction between impeller and casing. Replace damaged parts.
	Shaft bent due to damage – through shipment, operation, or overhaul.	Check deflection of rotor by turning on bearing journals. Total indicator run-out should not exceed 0.002 on shaft and 0.004 on impeller wearing surface.
	Mechanical failure of critical pump parts.	Check bearings and impeller for damage. Any irregularity in these parts will cause a drag on shaft.
	Misalignment	Realign pump and driver.
	Speed may be too high (brake hp of pump varies as the cube of the speed; therefore, any increase in speed means considerable increase in power demand).	Check voltage on motor.
	Electrical defects.	The voltage and frequency of the electrical current may be lower than that for which the motor was built; or there may be defects in motor. The motor may not be ventilated properly due to poor location.
	Mechanical defects in turbine, engine or other type of drive exclusive of motor.	If trouble cannot be located, consult factory.

# 8 Product warranty

## Commercial warranty

**Warranty.** For goods sold to commercial buyers, Seller warrants the goods sold to Buyer hereunder (with the exception of membranes, seals, gaskets, elastomer materials, coatings and other "wear parts" or consumables all of which are not warranted except as otherwise provided in the quotation or sales form) will be (i) be built in accordance with the specifications referred to in the quotation or sales form, if such specifications are expressly made a part of this Agreement, and (ii) free from defects in material and workmanship for a period of one (1) year from the date of installation or eighteen (18) months from the date of shipment (which date of shipment shall not be greater than thirty (30) days after receipt of notice that the goods are ready to ship), whichever shall occur first, unless a longer period is specified in the product documentation (the "Warranty").

Except as otherwise required by law, Seller shall, at its option and at no cost to Buyer, either repair or replace any product which fails to conform with the Warranty provided Buyer gives written notice to Seller of any defects in material or workmanship within ten (10) days of the date when any defects or non-conformance are first manifest. Under either repair or replacement option, Seller shall not be obligated to remove or pay for the removal of the defective product or install or pay for the installation of the replaced or repaired product and Buyer shall be responsible for all other costs, including, but not limited to, service costs, shipping fees and expenses. Seller shall have sole discretion as to the method or means of repair or replacement. Buyer's failure to comply with Seller's repair or replacement directions shall terminate Seller's obligations under this Warranty and render the Warranty void. Any parts repaired or replaced under the Warranty are warranted only for the balance of the warranty period on the parts that were repaired or replaced. Seller shall have no warranty obligations to Buyer with respect to any product or parts of a product that have been: (a) repaired by third parties other than Seller or without Seller's written approval; (b) subject to misuse, misapplication, neglect, alteration, accident, or physical damage; (c) used in a manner contrary to Seller's instructions for installation, operation and maintenance; (d) damaged from ordinary wear and tear, corrosion, or chemical attack; (e) damaged due to abnormal conditions, vibration, failure to properly prime, or operation without flow; (f) damaged due to a defective power supply or improper electrical protection; or (g) damaged resulting from the use of accessory equipment not sold or approved by Seller. In any case of products not manufactured by Seller, there is no warranty from Seller; however, Seller will extend to Buyer any warranty received from Seller's supplier of such products.

**THE FOREGOING WARRANTY IS EXCLUSIVE AND IN LIEU OF ANY AND ALL OTHER EXPRESS OR IMPLIED WARRANTIES, GUARANTEES, CONDITIONS OR TERMS OF WHATEVER NATURE RELATING TO THE GOODS PROVIDED HEREUNDER, INCLUDING WITHOUT LIMITATION ANY IMPLIED WARRANTIES OF MERCHANTABILITY AND FITNESS FOR A PARTICULAR PURPOSE, WHICH ARE HEREBY EXPRESSLY DISCLAIMED AND EXCLUDED. EXCEPT AS OTHERWISE REQUIRED BY LAW, BUYER'S EXCLUSIVE REMEDY AND SELLER'S AGGREGATE LIABILITY FOR BREACH OF ANY OF THE FOREGOING WARRANTIES ARE LIMITED TO REPAIRING OR REPLACING THE PRODUCT AND SHALL IN ALL CASES BE LIMITED TO THE AMOUNT PAID BY THE BUYER FOR THE DEFECTIVE PRODUCT. IN NO EVENT SHALL SELLER BE LIABLE FOR ANY OTHER FORM OF DAMAGES, WHETHER DIRECT, INDIRECT, LIQUIDATED, INCIDENTAL, CONSEQUENTIAL, PUNITIVE, EXEMPLARY OR SPECIAL DAMAGES, INCLUDING BUT NOT LIMITED TO LOSS OF PROFIT, LOSS OF ANTICIPATED SAVINGS OR REVENUE, LOSS OF INCOME, LOSS OF BUSINESS, LOSS OF PRODUCTION, LOSS OF OPPORTUNITY OR LOSS OF REPUTATION.**

**Limited consumer warranty**

**Warranty.** For goods sold for personal, family or household purposes, Seller warrants the goods purchased hereunder (with the exception of membranes, seals, gaskets, elastomer materials, coatings and other "wear parts" or consumables all of which are not warranted except as otherwise provided in the quotation or sales form) will be free from defects in material and workmanship for a period of one (1) year from the date of installation or eighteen (18) months from the product date code, whichever shall occur first, unless a longer period is provided by law or is specified in the product documentation (the "Warranty").

Except as otherwise required by law, Seller shall, at its option and at no cost to Buyer, either repair or replace any product which fails to conform with the Warranty provided Buyer gives written notice to Seller of any defects in material or workmanship within ten (10) days of the date when any defects or non-conformance are first manifest. Under either repair or replacement option, Seller shall not be obligated to remove or pay for the removal of the defective product or install or pay for the installation of the replaced or repaired product and Buyer shall be responsible for all other costs, including, but not limited to, service costs, shipping fees and expenses. Seller shall have sole discretion as to the method or means of repair or replacement. Buyer's failure to comply with Seller's repair or replacement directions shall terminate Seller's obligations under this Warranty and render this Warranty void. Any parts repaired or replaced under the Warranty are warranted only for the balance of the warranty period on the parts that were repaired or replaced. The Warranty is conditioned on Buyer giving written notice to Seller of any defects in material or workmanship of warranted goods within ten (10) days of the date when any defects are first manifest.

Seller shall have no warranty obligations to Buyer with respect to any product or parts of a product that have been: (a) repaired by third parties other than Seller or without Seller's written approval; (b) subject to misuse, misapplication, neglect, alteration, accident, or physical damage; (c) used in a manner contrary to Seller's instructions for installation, operation and maintenance; (d) damaged from ordinary wear and tear, corrosion, or chemical attack; (e) damaged due to abnormal conditions, vibration, failure to properly prime, or operation without flow; (f) damaged due to a defective power supply or improper electrical protection; or (g) damaged resulting from the use of accessory equipment not sold or approved by Seller. In any case of products not manufactured by Seller, there is no warranty from Seller; however, Seller will extend to Buyer any warranty received from Seller's supplier of such products.

**THE FOREGOING WARRANTY IS PROVIDED IN PLACE OF ALL OTHER EXPRESS WARRANTIES. ALL IMPLIED WARRANTIES, INCLUDING BUT NOT LIMITED TO THE IMPLIED WARRANTIES OF MERCHANTABILITY AND FITNESS FOR A PARTICULAR PURPOSE, ARE LIMITED TO ONE (1) YEAR FROM THE DATE OF INSTALLATION OR EIGHTEEN (18) MONTHS FROM THE PRODUCT DATE CODE, WHICHEVER SHALL OCCUR FIRST. EXCEPT AS OTHERWISE REQUIRED BY LAW, BUYER'S EXCLUSIVE REMEDY AND SELLER'S AGGREGATE LIABILITY FOR BREACH OF ANY OF THE FOREGOING WARRANTIES ARE LIMITED TO REPAIRING OR REPLACING THE PRODUCT AND SHALL IN ALL CASES BE LIMITED TO THE AMOUNT PAID BY THE BUYER FOR THE DEFECTIVE PRODUCT. IN NO EVENT SHALL SELLER BE LIABLE FOR ANY OTHER FORM OF DAMAGES, WHETHER DIRECT, INDIRECT, LIQUIDATED, INCIDENTAL, CONSEQUENTIAL, PUNITIVE, EXEMPLARY OR SPECIAL DAMAGES, INCLUDING BUT NOT LIMITED TO LOSS OF PROFIT, LOSS OF ANTICIPATED SAVINGS OR REVENUE, LOSS OF INCOME, LOSS OF BUSINESS, LOSS OF PRODUCTION, LOSS OF OPPORTUNITY OR LOSS OF REPUTATION.**

Some states do not allow limitations on how long an implied warranty lasts, so the above limitation may not apply to you. Some states do not allow the exclusion or limitation of incidental or consequential damages, so the above exclusions may not apply to you. This warranty gives you specific legal rights, and you may also have other rights which may vary from state to state.

To make a warranty claim, check first with the dealer from whom you purchased the product or visit [www.xylem.com](http://www.xylem.com) for the name and location of the nearest dealer providing warranty service.

# Xylem |'zīləm|

- 1) The tissue in plants that brings water upward from the roots;
- 2) a leading global water technology company.

We're a global team unified in a common purpose: creating advanced technology solutions to the world's water challenges. Developing new technologies that will improve the way water is used, conserved, and re-used in the future is central to our work. Our products and services move, treat, analyze, monitor and return water to the environment, in public utility, industrial, residential and commercial building services settings. Xylem also provides a leading portfolio of smart metering, network technologies and advanced analytics solutions for water, electric and gas utilities. In more than 150 countries, we have strong, long-standing relationships with customers who know us for our powerful combination of leading product brands and applications expertise with a strong focus on developing comprehensive, sustainable solutions.

For more information on how Xylem can help you, go to [www.xylem.com](http://www.xylem.com)



Xylem Inc.  
1 Goulds Drive  
Auburn - NY 13021  
USA  
Tel: +1 (866) 325-4210  
Fax: +1 (800) 322-5877  
[www.xylem.com/  
gouldswatertechnology](http://www.xylem.com/gouldswatertechnology)

Visit our Web site for the latest version of this document and more information

The original instruction is in English. All non-English instructions are translations of the original instruction.

© 2019 Xylem Inc