

JOB:	REPRESENTATIVE:	
UNIT TAG:	ORDER NO.:	DATE:
ENGINEER:	SUBMITTED BY:	DATE:
CONTRACTOR:	APPROVED BY:	DATE:

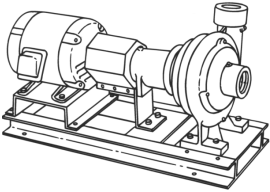

1.25-9C

Marlow Series e-530SL

Centrifugal Pumps - Base Mounted

SPECIFICATIONS

FLOW _____ HEAD _____
 HP _____ RPM _____
 VOLTS _____
 CYCLE _____ PHASE _____
 ENCLOSURE _____
 APPROX. WEIGHT _____
 SPECIALS _____

MATERIALS OF CONSTRUCTION

Stainless Steel Fitted

FEATURES

- ANSI/OSHA Coupling Guard
- Center Drop Out Spacer Coupling
- Fabricated Heavy Duty Baseplate

MAXIMUM WORKING PRESSURE

175 psi (12 bar) W.P.
 w/ 125# ANSI flange drilling

TYPE OF SEAL

- Standard Seal (Buna-Carbon/Ceramic)
- F Standard Seal w/ Flush Line (Buna-Carbon/Ceramic)
- S Stuffing Box Construction w/ Flushed Mechanical Single Seal (EPR-Tungsten Carbide/Carbon)
- PF Stuffing Box Construction w/ Packing (Graphite Impregnated Teflon)

Note: Equipped with NEOPRENE coupling

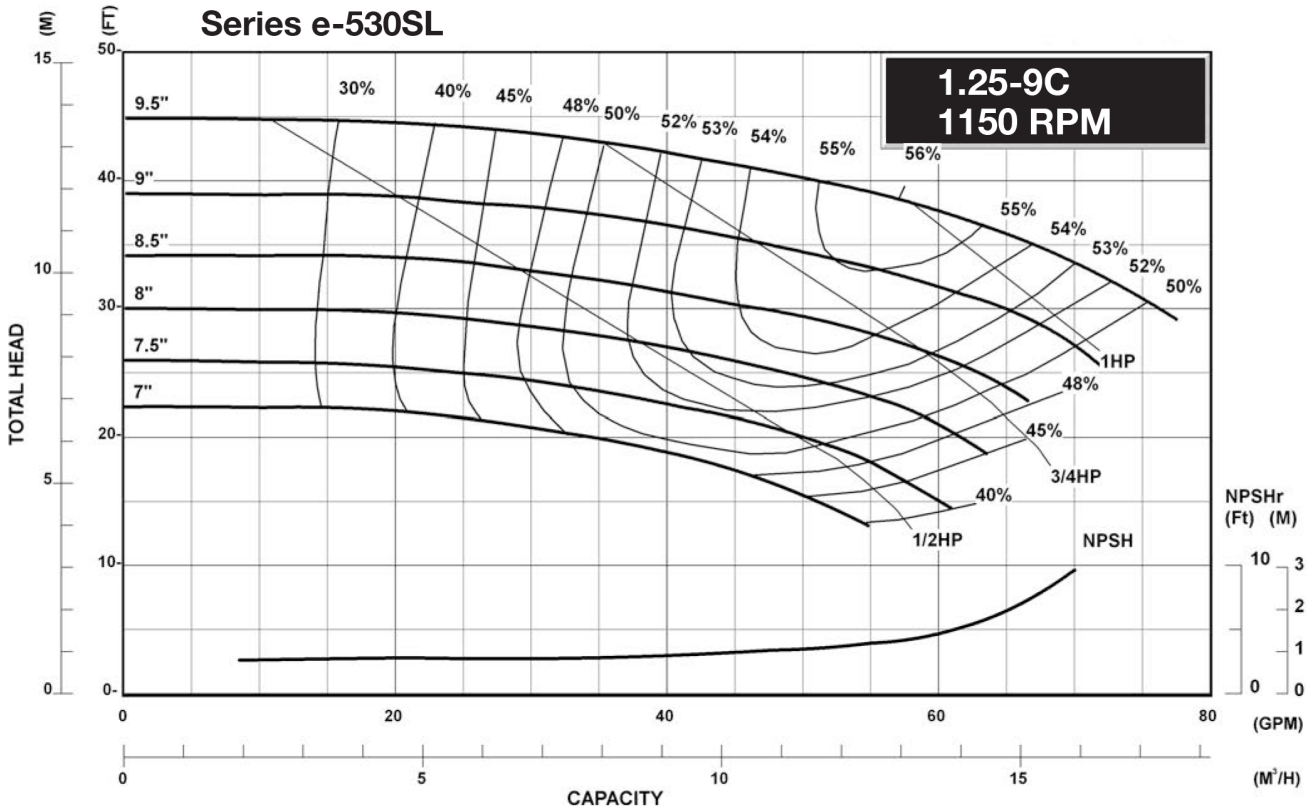

JOB: UNIT TAG: ENGINEER: CONTRACTOR:	REPRESENTATIVE: ORDER NO.: SUBMITTED BY: APPROVED BY:	DATE: DATE: DATE:
---	--	--

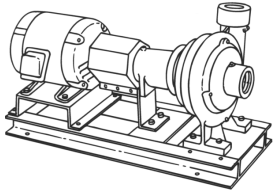

1.25-9C

Marlow Series e-530SL

Centrifugal Pumps - Base Mounted

SPECIFICATIONS

FLOW _____ HEAD _____
 HP _____ RPM _____
 VOLTS _____
 CYCLE _____ PHASE _____
 ENCLOSURE _____
 APPROX. WEIGHT _____
 SPECIALS _____

MATERIALS OF CONSTRUCTION

Stainless Steel Fitted

FEATURES

- ANSI/OSHA Coupling Guard
- Center Drop Out Spacer Coupling
- Fabricated Heavy Duty Baseplate

MAXIMUM WORKING PRESSURE

175 psi (12 bar) W.P.
 w/ 125# ANSI flange drilling

TYPE OF SEAL

- Standard Seal (Buna-Carbon/Ceramic)
- F Standard Seal w/ Flush Line (Buna-Carbon/Ceramic)
- S Stuffing Box Construction w/ Flushed Mechanical Single Seal (EPR-Tungsten Carbide/Carbon)
- PF Stuffing Box Construction w/ Packing (Graphite Impregnated Teflon)

Note: Equipped with NEOPRENE coupling

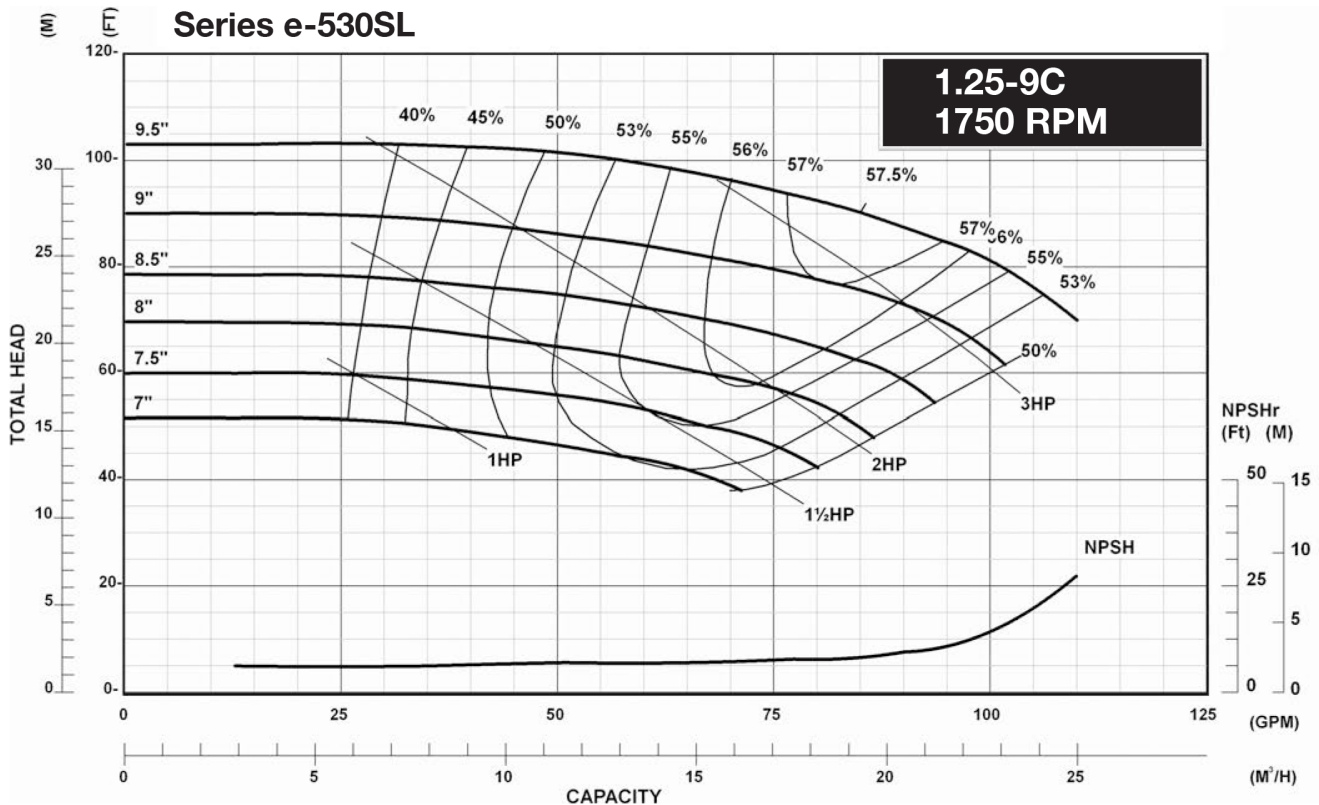

JOB:	REPRESENTATIVE:	
UNIT TAG:	ORDER NO.:	DATE:
ENGINEER:	SUBMITTED BY:	DATE:
CONTRACTOR:	APPROVED BY:	DATE:

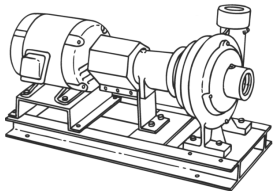

1.25-9C Marlow Series e-530SL Centrifugal Pumps - Base Mounted

SPECIFICATIONS

FLOW _____ HEAD _____
 HP _____ RPM _____
 VOLTS _____
 CYCLE _____ PHASE _____
 ENCLOSURE _____
 APPROX. WEIGHT _____
 SPECIALS _____

MATERIALS OF CONSTRUCTION

Stainless Steel Fitted

FEATURES

- ANSI/OSHA Coupling Guard
- Center Drop Out Spacer Coupling
- Fabricated Heavy Duty Baseplate

MAXIMUM WORKING PRESSURE

175 psi (12 bar) W.P.
 w/ 125# ANSI flange drilling

TYPE OF SEAL

- Standard Seal (Buna-Carbon/Ceramic)
- F Standard Seal w/ Flush Line (Buna-Carbon/Ceramic)
- S Stuffing Box Construction w/ Flushed Mechanical Single Seal (EPR-Tungsten Carbide/Carbon)
- PF Stuffing Box Construction w/ Packing (Graphite Impregnated Teflon)

Note: Equipped with NEOPRENE coupling

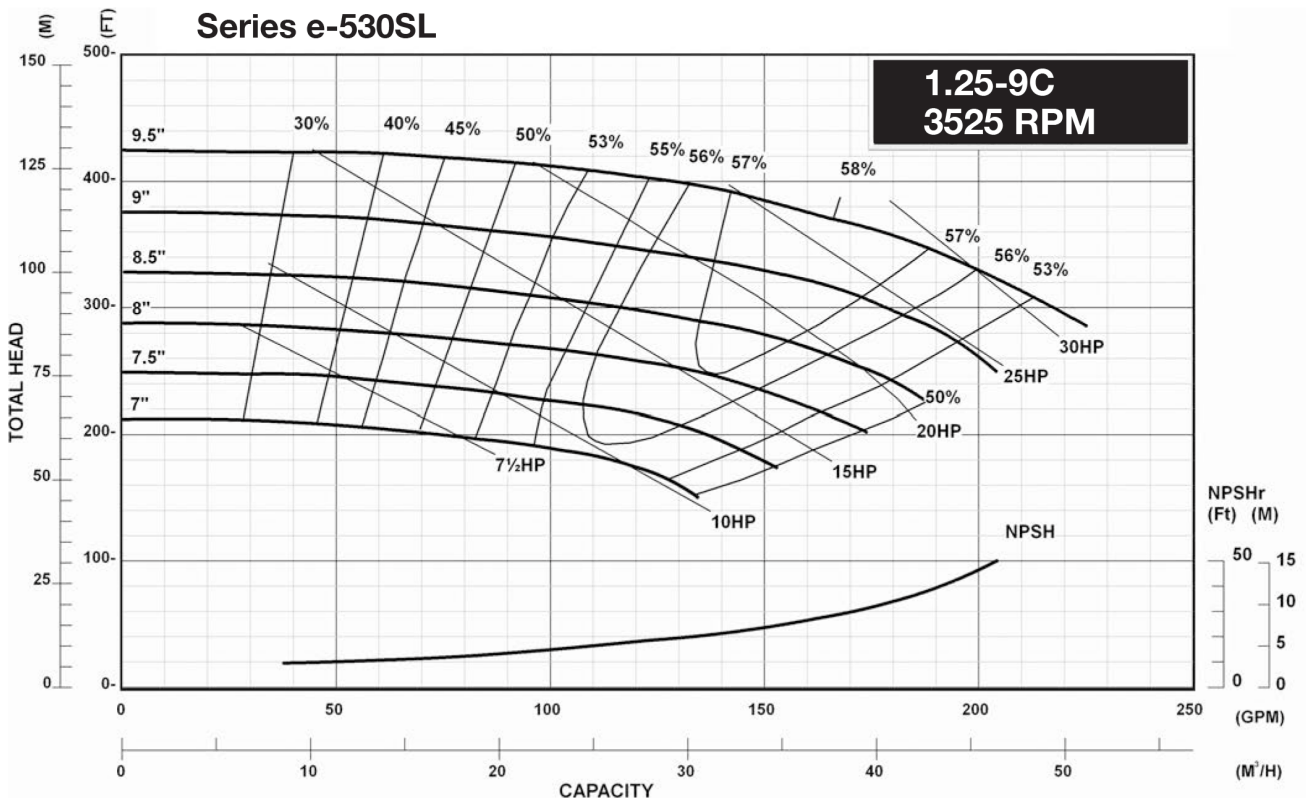

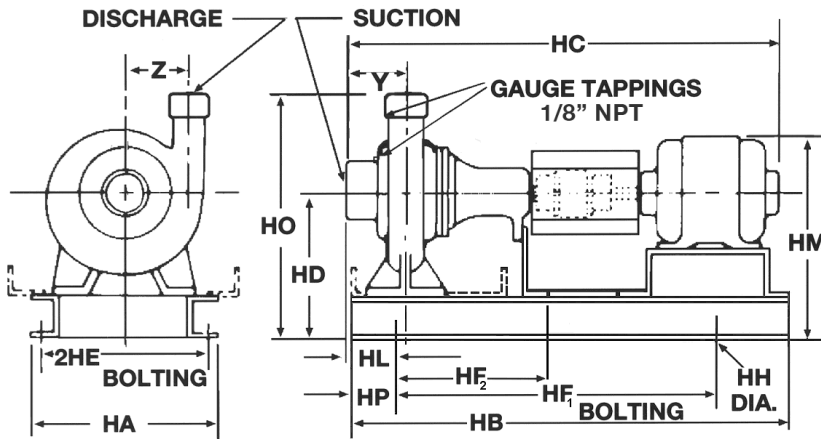

NOZZLE SIZES	
Discharge	1-1/4" N.P.T.
Suction	1-1/2" N.P.T.

DIMENSIONS – Inches (mm)

STANDARD SEAL

MOTOR FRAME	HA	HB	HC MAX	HD	2HE	HF ₁	HF ₂	HH	HL	HM MAX	HO	HP	Y	Z
"S" FRAME														
143T	14-5/8 (371)	31 (787)	28-5/8 (727)	10-3/4 (273)	12-7/8 (327)	25 (635)	-	3/4 (19)	1-13/16 (46)	14-1/2 (368)	18-3/4 (476)	3 (76)	3-1/4 (83)	5-1/2 (140)
145T	14-5/8 (371)	31 (787)	29-5/8 (752)	10-3/4 (273)	12-7/8 (327)	25 (635)	-	3/4 (19)	1-13/16 (46)	14-1/2 (368)	18-3/4 (476)	3 (76)	3-1/4 (83)	5-1/2 (140)
182T	14-5/8 (371)	31 (787)	32-1/4 (819)	10-3/4 (273)	12-7/8 (327)	25 (635)	-	3/4 (19)	1-13/16 (46)	16 (406)	18-3/4 (476)	3 (76)	3-1/4 (83)	5-1/2 (140)
184T	14-5/8 (371)	31 (787)	33 (838)	10-3/4 (273)	12-7/8 (327)	25 (635)	-	3/4 (19)	1-13/16 (46)	16 (406)	18-3/4 (476)	3 (76)	3-1/4 (83)	5-1/2 (140)
"L" FRAME														
213T	14-5/8 (371)	39-3/8 (1000)	39-7/8 (1013)	10-3/4 (273)	12-7/8 (327)	33-3/8 (848)	-	3/4 (19)	1-13/16 (46)	16-5/8 (422)	18-3/4 (476)	3 (76)	3-1/4 (83)	5-1/2 (140)
215T	14-5/8 (371)	39-3/8 (1000)	41-3/8 (1051)	10-3/4 (273)	12-7/8 (327)	33-3/8 (848)	-	3/4 (19)	1-13/16 (46)	16-5/8 (422)	18-3/4 (476)	3 (76)	3-1/4 (83)	5-1/2 (140)
254T	16 (406)	46-1/2 (1181)	45-1/8 (1146)	12 (305)	14 (356)	36-1/2 (927)	18-1/4 (464)	7/8 (22)	2-15/16 (75)	18-7/8 (479)	20 (508)	5 (127)	3-1/4 (83)	5-1/2 (140)
256T	16 (406)	46-1/2 (1181)	46-7/8 (1191)	12 (305)	14 (356)	36-1/2 (927)	18-1/4 (464)	7/8 (22)	2-15/16 (75)	18-7/8 (479)	20 (508)	5 (127)	3-1/4 (83)	5-1/2 (140)
284TS	16 (406)	46-1/2 (1181)	46-1/4 (1175)	13 (330)	14 (356)	36-1/2 (927)	18-1/4 (464)	7/8 (22)	2-15/16 (75)	21 (533)	21 (533)	5 (127)	3-1/4 (83)	5-1/2 (140)
286TS	16 (406)	46-1/2 (1181)	47-3/4 (1213)	13 (330)	14 (356)	36-1/2 (927)	18-1/4 (464)	7/8 (22)	2-15/16 (75)	21 (533)	21 (533)	5 (127)	3-1/4 (83)	5-1/2 (140)

STUFFING BOX

MOTOR FRAME	HA	HB	HC MAX	HD	2HE	HF ₁	HF ₂	HH	HL	HM MAX	HO	HP	Y	Z
"S" FRAME														
143T	14-5/8 (371)	34-5/8 (879)	32-1/8 (816)	10-3/4 (273)	12-7/8 (327)	28-5/8 (727)	-	3/4 (19)	1-13/16 (46)	14-1/2 (368)	18-3/4 (476)	3 (76)	3-1/4 (83)	5-1/2 (140)
145T	14-5/8 (371)	34-5/8 (879)	33-1/8 (841)	10-3/4 (273)	12-7/8 (327)	28-5/8 (727)	-	3/4 (19)	1-13/16 (46)	14-1/2 (368)	18-3/4 (476)	3 (76)	3-1/4 (83)	5-1/2 (140)
182T	14-5/8 (371)	34-5/8 (879)	35-7/8 (911)	10-3/4 (273)	12-7/8 (327)	28-5/8 (727)	-	3/4 (19)	1-13/16 (46)	16 (406)	18-3/4 (476)	3 (76)	3-1/4 (83)	5-1/2 (140)
184T	14-5/8 (371)	34-5/8 (879)	36-5/8 (930)	10-3/4 (273)	12-7/8 (327)	28-5/8 (727)	-	3/4 (19)	1-13/16 (46)	16 (406)	18-3/4 (476)	3 (76)	3-1/4 (83)	5-1/2 (140)
"L" FRAME														
213T	16 (406)	46-1/2 (1181)	42-3/8 (1076)	12 (305)	14 (356)	36-1/2 (927)	18-1/4 (464)	7/8 (22)	2-15/16 (75)	17-7/8 (454)	20 (508)	5 (127)	3-1/4 (83)	5-1/2 (140)
215T	16 (406)	46-1/2 (1181)	43-7/8 (1114)	12 (305)	14 (356)	36-1/2 (927)	18-1/4 (464)	7/8 (22)	2-15/16 (75)	17-7/8 (454)	20 (508)	5 (127)	3-1/4 (83)	5-1/2 (140)
254T	16 (406)	51-3/4 (1314)	47-5/8 (1210)	12 (305)	14 (356)	41-3/4 (1060)	20-7/8 (530)	7/8 (22)	2-15/16 (75)	18-7/8 (479)	20 (508)	5 (127)	3-1/4 (83)	5-1/2 (140)
256T	16 (406)	51-3/4 (1314)	49-3/8 (1254)	12 (305)	14 (356)	41-3/4 (1060)	20-7/8 (530)	7/8 (22)	2-15/16 (75)	18-7/8 (479)	20 (508)	5 (127)	3-1/4 (83)	5-1/2 (140)
284TS	16 (406)	51-3/4 (1314)	48-5/8 (1235)	13 (330)	14 (356)	41-3/4 (1060)	20-7/8 (530)	7/8 (22)	2-15/16 (75)	21 (533)	21 (533)	5 (127)	3-1/4 (83)	5-1/2 (140)
286TS	16 (406)	51-3/4 (1314)	50-1/8 (1273)	13 (330)	14 (356)	41-3/4 (1060)	20-7/8 (530)	7/8 (22)	2-15/16 (75)	21 (533)	21 (533)	5 (127)	3-1/4 (83)	5-1/2 (140)

Dimensions are subject to change. Not to be used for construction purposes unless certified.

Xylem Inc.
8200 N. Austin Avenue
Morton Grove, IL 60053
Phone: (847)966-3700
Fax: (847)965-8379
www.gouldswatertechnology.com

