



Lowara Product Guide

LET'S SOLVE WATER



Xylem is focused on helping our customers solve their most challenging water issues: treating water to make it potable, transporting it to where it is needed, using it in the most efficient manner, testing and analyzing its qualities and cleaning it after its many uses.



CONTENTS

Domestic Pressure Pumps Water pressure systems with automatic pump controller: BGR, BGM, e-HM, HME	06
Vertical Multistage Pumps Inline vertical multistage: e-SV	11
Horizontal Multistage Pumps Horizontal multistage: e-HM	16
Circulators Wet rotor: ecocirc XL / XLplus Heating Circulator: ecocirc Premium Domestic hot water: ecocirc Pro Wet rotor: TLCN - TLCHN Hydraulic motor: e-LNE	20
Borehole Pumps & Motors 4" Submersible: e-GS 6" Submersible: Z6-ZN6 8", 10", 12" Submersible: Z8-ZR8, Z10-ZR10, Z12-ZR12 4" Submersible motors & control panels: 4OS, QPC 6", 8", 10", 12" Submersible motors: L6C & L6CN, L6W & L8W, L10W & L12W	26
Variable Speed Control Variable Speed Drive Controller: HYDROVAR®	35
End Suction Centrifugal Pumps Open impeller close coupled: CO Stainless steel close coupled end suction: CEA Stainless steel close coupled twin impeller end suction: CA End Suction: eNSC Stainless steel end suction close coupled: eSH	37
Submersible Pumps for Dewatering and Sewage Submersible dewatering: DOC, DIWA, DN Submersible wastewater: DOMO Grinder: DOMO GRI Large submersible: GL & DL Multistage centrifugal submersible: SCUBA Submersible: Lowara 1300 Series	46
Goulds Water Technology Pumps Horizontal centrifugal ISO: GIS-GISO Lineshaft & submersible turbines	54
Lowara Vogel Series Pumps Multistage: e-MP series	58
GHV Booster Sets GHV / SV series	59
Pressure Tanks Pressure Wave, C2 Lite, Challenger Tank	61
Appendix Pump fundamentals Piping frictional losses	62



Lowara takes great responsibility in rewriting the limitations on where water can go and how it gets there. We offer a complete range of energy efficient pumps, systems, and accessories for use in commercial buildings, homes, general industry, agriculture and irrigation.

See how Lowara is pushing water to realize it's potential at xylem.com/en-au/brands/lowara





**LOWARA
PUMPING IN
AUSTRALIA
& NEW ZEALAND
FOR MORE THAN
30 YEARS**

DOMESTIC PRESSURE PUMPS



Self Priming Domestic Jet Pump

BGR Series with Mondial Automatic Pump Controller

APPLICATIONS

- » Pressure boosting
- » Water transfer
- » Lawn and garden irrigation
- » Cistern filling

FEATURES

PUMP

Self-priming centrifugal jet pumps for handling clean water. Robust design with pressed stainless steel casing and an aluminium motor body. These pumps are equipped with built-in injector systems providing suction lift capability. This design arrangement allows the pumps to remain primed if there are gases in the pumped water. Available in 220-240V, 50Hz, Single phase

CONTROL

Compact and functional device incorporating an electronic circuit, a diaphragm and retaining spring board system integrated with delivery and pressure sensors. It is designed to replace traditional pressure switch control systems in domestic use. It offers the advantage of small overall dimensions, no routine maintenance is required and it also provides the pump with adequate protection against dry running.

Available in 200-240V, 50Hz, Single phase

OPTIONS

Also available as bare pumps without controller

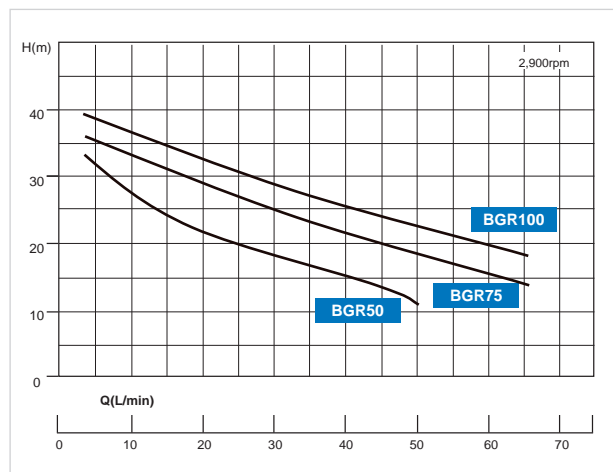

PUMP TYPE	RATED POWER kW	1/min m ³ /hr	0	10	20	30	40	50	60	65
			0	0.6	1.2	1.8	2.4	3	3.6	3.9
BGR050 + Mondial	0.37		34	27	22	18	15	11		
BGR075 + Mondial	0.55		36	33.5	28.2	25	22	18	15.8	14
BGR100 + Mondial	0.75		39.8	37	32.5	28	25	23.2	19.9	17.7

CentriPro PC Automatic Pump Controller

The CentriPro PC controller is a device designed to control pumps in domestic applications. Controlling the operating pressure, it will protect the pump from dry running to ensure your pump operates efficiently for many years.

Lowara e-HM and BGM pumps are available with CentriPro PC automatic pump controller.



DOMESTIC PRESSURE PUMPS



Self Priming Centrifugal Pump

BGM Series with CentriPro PC Automatic Pump Controller

Close-coupled self-priming centrifugal pumps with built-in injector system, designed to remain primed even in the presence of water-dissolved gases. The extensive use of pressed stainless steel ensures a high-performance, durable and lightweight pump.

Available in the "Garden" version with handle and terminal box with built in switch.



APPLICATIONS

- » Water distribution
- » Pressure boosting
- » Irrigation
- » Washing
- » Rain water collection
- » Fountains

SPECIFICATIONS

- » Delivery: up to 4.2m³/hr
- » Head: up to 53m
- » Power supply: Three phase and Single phase 50 and 60Hz
- » Power: 0.37kW to 1.1kW
- » Maximum operating pressure: 8 bar
- » Maximum total lift: 8m
- » Maximum ambient temperature: 40°C
- » Temperature of pumped liquid: -10°C to +40°C
- » Protection Class: IP 44
- » Insulation Class: F

MATERIALS

- » Pump body: Stainless steel
- » Impeller: Stainless steel
- » Diffuser: Technopolymer
- » Injector: Technopolymer
- » Seal housing: Stainless steel
- » Mechanical seal: Ceramic / Carbon / EPDM
- » Fill and drain plugs: Nickel-plated brass
- » Elastomer: EPDM

FEATURES

Compact and functional device incorporating an electronic circuit, a diaphragm and retaining spring board system integrated with delivery and pressure sensors. It is designed to replace traditional pressure switch control systems in domestic use. It offers the advantage of small overall dimensions, no routine maintenance is required and it also provides the pump with adequate protection against dry running.

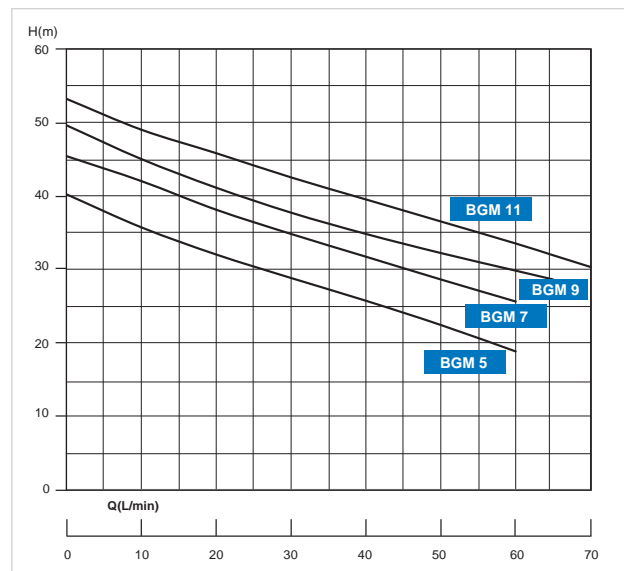

PUMP TYPE	RATED POWER kW	Flow Rate (Q)											
		0	10	20	30	40	50	60	65	70			
BGM5 + WPC2.2	0.55	40.2	35.7	32	28.8	25.7	22.4	18.8					
BGM7 + WPC2.2	0.75	45.4		38.1	34.8	31.7	28.6	25.6					
BGM9 + WPC2.2	0.9	45.4		41	37.7	34.8	32.2	29.8	28.6				
BGM11 + WPC2.2	1.1	53.2		45.8	42.5	39.5	36.5	33.5	31.9	30.3			

DOMESTIC PRESSURE PUMPS

Inline Horizontal Multistage Pump

THE NEW e-HM:
LARGER RANGE
BEST IN CLASS
EFFICIENCY
AND MORE OPTIONS

e-HM Series with CentriPro PC Automatic Pump Controller

MARKET SECTIONS

- » Domestic Building Services
- » Light Industrial

APPLICATIONS

- » Pressure boosting and water supply systems
- » Washing and cleaning industry including vehicle washing
- » Circulation of hot and cold liquids (water and glycol) for heating, cooling and airconditioning systems
- » Water treatment applications
- » Handling of moderately aggressive liquids
- » Food and beverage industries
- » Rainwater Harvesting

SPECIFICATIONS

PUMP

- » Flow rate: up to 29m³/h
- » Head: up to 160m
- » Ambient temperature:
 - Three phase motor versions from -30°C to +50°C
 - Single phase motor versions from -30°C to +45°C (From -30°C to +40°C for 0.95kW motor)
- » Temperature of the pumped liquid:
 - +90°C for versions with Three phase motor uses as EN60335-2-41
 - +120°C for versions with Three phase motor and stainless steel impeller (HM..S, HM..N) uses other than EN60335-2-41
- » +60°C for versions with Single phase motor
- » Maximum operating pressure:
 - 10 bar (PN 60) for pumps with Noryl™ impeller
 - 16 bar (PN 16) for pumps with stainless steel impeller and Q1BEGG or Q1Q1EGG mechanical seal (maximum liquid temperature +90°C)
- » Connections: Rp threaded for both suction and discharge manifold
- » Hydraulic performances compliant with ISO 9906: 2012 - Grade 3B



MOTOR

- » Electric short-circuit squirrel-cage motor (TEFC), enclosed construction, air-cooled, 2 pole:
 - Three phase, efficiency class IE3 (compliant with Regulation (EC) n. 640/2009 and IEC 60034-30)
 - Single phase version up to 2.2 kW (with built-in automatic reset overload protection)
- » Protection Class: IP 44
- » Insulation Class: F
- » Performances according to EN 60034-1
- » Standard Voltage:
 - Single phase: 220-240V, 50Hz
 - Three phase: 220-240/380-415V, 50Hz up to 3kW
 - 380/415/660-690V, 50Hz from 4kW included

DOMESTIC PRESSURE PUMPS

3HM P Version + APC

PUMP TYPE	RATED POWER kW	LITRES PER MINUTE							
		0	20	28	36	44	52	60	70
3HM04P + WPC1.5	0.50	44.6	39.2	36.1	32.5	28.4	24.1	19.3	10.3
3HM05P + WPC2.2	0.75	57.5	51.4	48.0	43.8	39.1	33.7	27.8	17.2
3HM06P + WPC2.2	0.95	69.3	61.9	57.8	52.7	47.1	40.7	33.7	21.6

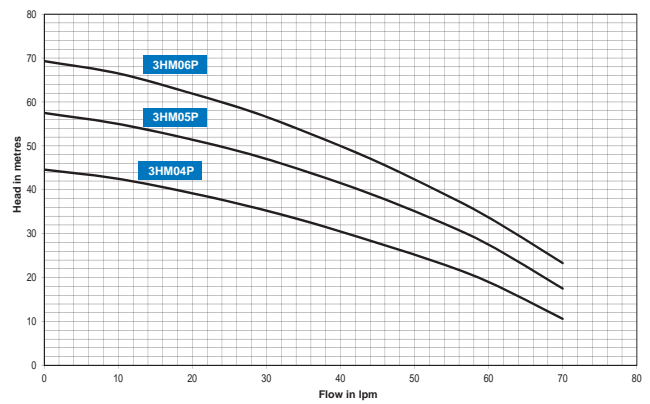

5HM P Version + APC

PUMP TYPE	RATED POWER kW	LITRES PER MINUTE							
		0	40	53	66	79	92	105	
5HM04P + WPC1.5	0.75	46.6	37.9	34.7	30.5	24.6	17.9	11.0	
5HM05P + WPC2.2	0.95	58.4	47.5	43.5	38.5	31.7	23.9	15.6	
5HM06P + WPC2.2	1.1	71.0	58.6	54.0	48.3	40.6	31.8	22.3	

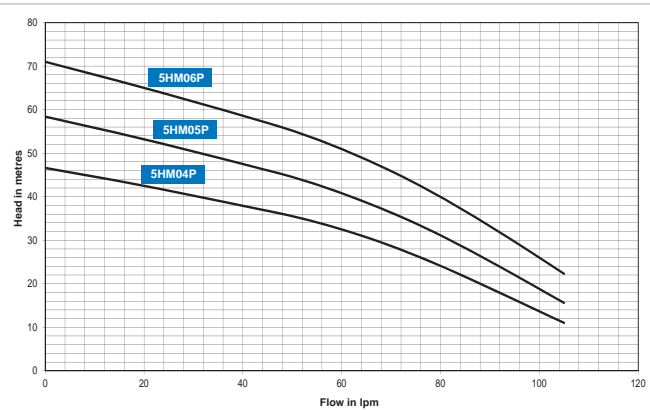

3HM S Version + APC

PUMP TYPE	RATED POWER kW	LITRES PER MINUTE							
		0	40	53	66	79	92	105	
3HM04S + WPC1.5	0.50	29.5	27.7	25.8	23.7	21.0	17.8	13.1	
3HM05S + WPC1.5	0.50	36.6	35.2	32.0	29.5	25.9	21.8	15.6	
3HM07S + WPC2.2	0.55	51.7	50.1	47.0	43.7	38.0	31.3	24.2	

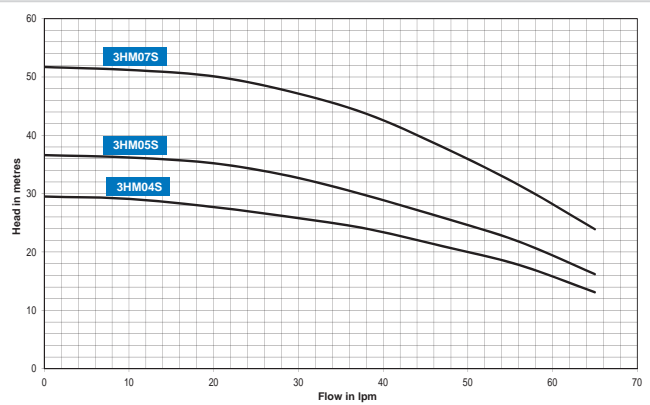

5HM S Version + APC

PUMP TYPE	RATED POWER kW	LITRES PER MINUTE							
		0	40	53	66	79	92	105	
5HM04S + WPC1.5	0.50	29.2	25.2	23.3	18.1	12.0	8.5		
5HM06S + WPC2.2	0.75	44.2	39.7	36.9	30.9	23.6	18.6	16.1	
5HM08S + WPC2.2	0.95	58.8	53.0	49.1	41.9	33.3	26.7	23.9	

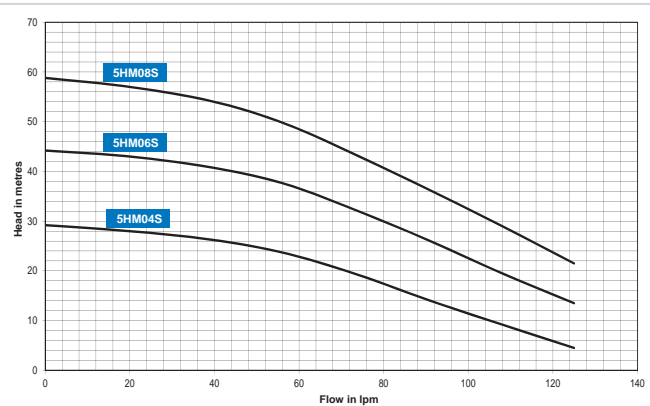

DOMESTIC PRESSURE PUMPS



Ensuring a reliable water supply

HME Smart Pump Range

A complete system delivering market-leading efficiency. The Lowara Smart Pump range incorporates state-of-the-art technology to optimize performance, communicate with other building systems and help you achieve your goals. Choose pre-programmed packages for easy, cost-effective installation - and benefit from this system's power, intelligence and performance.

INTELLIGENCE

The smart, easy-to-set integrated drive can operate single, twin or multipump systems of up to three pumps, with no need for an external control panel or PLC. The drive matches performance to demand, reducing energy use. And it allows smart pumps to communicate with other building systems in real time, maximizing efficiency.

EFFICIENCY

Lowara Smart Pumps combine three essential elements to ensure outstanding reliability, optimal savings and the shortest payback times. It's not about individual components. It's about a great team of three perfectly concerted elements:

- » Ultra-premium IE5 motors for best-in-class efficiency, according to IEC/TS 60034-30-2
- » Power drive system (drive and motor) in the highest efficiency class, IES2, according to EN 50598-2
- » Hydraulic pump designed for exceptional Minimum Efficiency Index (MEI) ratings, according to EU Regulation No. 547/2012

SPECIFICATIONS

PUMP

- » Voltage: 208 to 240V
- » Power: up to 1.5 kW
- » Multipump capability: up to 3 units
- » Power supply: single phase 50/60 Hz
- » Communication: BACnet and Modbus standard in single pumps
- » IES2 package with IE5 motors
- » Enclosure rate: IP55
- » EMC: C1-category compliant with EN 61800-3 for residential environment
- » Harmonics: compliant with IEC/EN 61000-3-2



OPTIONS

The Following Ranges are available in smart pump variants:

- e-HME** Delivery: up to 29 m³/h, Head: up to 55 m
- e-SVE** Delivery: up to 30 m³/h, Head: up to 180 m
- e-LNESE** Delivery: up to 38 m³/h, Head: up to 35 m
- SMB** Delivery: up to 90 m³/h, Head: up to 150 m

VERTICAL MULTISTAGE PUMPS



Inline Vertical Multistage Pump

e-SV Series

The e-SV is a technologically advanced pump renowned for excellent performance and leading efficiencies with high reliability. With a wide range of sizes available, it is capable of meeting customer needs for various industries.

APPLICATIONS

- » AS/NZS 4020 Compliant; Suitable for drinking water
- » Ideal for use with the HYDROVAR® Variable Speed Drive (VSD) controller: see pages 31-32
- » Handling of water, free of suspended solids, in the civil, industrial and agricultural sectors
- » Pressure boosting and water supply systems
- » Irrigation systems
- » Wash systems
- » Water treatment plants
- » Handling of moderately aggressive liquids, demineralized water and glycol, etc
- » Circulation of hot and cold water for heating, cooling and airconditioning systems
- » Boiler feed
- » Pharmaceutical industries
- » Food and beverage industries

SPECIFICATIONS

PUMP

The e-SV pump is a non-self priming vertical multistage pump coupled to a standard motor. The liquid end, located between the upper cover and the pump casing, is held in place by tie rods. The pump casing is available with different configurations and connection types.

- » Delivery: up to 160 m³/hr
- » Head: up to 330m
- » Temperature of pumped liquid:
 - from -30°C to +120°C for standard version
- » Maximum operating pressure:
 - 1, 3, 5, 10, 15, 22SV with oval flanges: 16 bar (PN16)
 - 1, 3, 5, 10, 15, 22SV with round flanges or Victaulic®, Clamp or DIN 11851 connections: 25 bar (PN 25)
 - 33,46SV: 16, 25, 40 bar (PN16, PN25 or PN40)
 - 66, 92, 125SV: 16 or 25 bar (PN16 or PN25)
- » Tested in compliance with ISO 9906 - Annex A

MATERIALS

- » Standard construction:
 - 15V to 22SV all wetted parts in 304SS;
 - 33SV to 125SV wetted parts in 304SS/316SS/CI
- » SVS construction: 33SV to 92SV all wetted part in 304SS
- » SVN construction: all wetted parts in 316SS



MOTOR

- » Squirrel cage enclosed construction with external ventilation
- » Protection Class: IP 55
- » Insulation Class: F
- » Performances according to EN 60034-1
- » Standard voltage:
 - Single phase version: 220-240V, 50Hz
 - Three phase version: 220-240/380-415V, 380-415/660-690V, 50Hz for power above 3kW
- Standard motors comply with MEPS

OPTIONS

- » High pressure pump, horizontal version, low NPSH version, high temperature version, passivated and electro-polished version are also available upon request

VERTICAL MULTISTAGE PUMPS

FEATURES of 1, 3, 5, 10, 15 & 22SV SERIES

- » Vertical multistage centrifugal pump. All metal parts in contact with the pumped liquid are made of stainless steel
- » Reduced axial thrusts enable the use of standard motors that are easily found in the market. The SM $\geq 0,75$ kW and PLM surface motors have efficiency values that fall within the range normally referred to as efficiency class IE2
- » Seal housing chamber designed to prevent the accumulation of air in the critical area next to the mechanical seal
- » Mechanical seal according to EN 12756 (ex DIN 24960) and ISO 3069 for 1, 3, 5SV and 10, 15, 22SV (≤ 4 kW) series
- » Easy maintenance. No special tools required for assembly or disassembly
- » With round flanges that can be coupled to counter-flanges, according to EN 1092

FEATURES of 33, 46, 66, 92 & 125SV SERIES

- » Version G: vertical multistage centrifugal pump with impellers, diffusers and outer sleeve made entirely of stainless steel, and with pump casing and motor adaptor made of cast iron
- » Innovative axial load compensation system on pumps with higher head. This ensures reduced axial thrusts and enables the use of standard motors that are easily found in the market
- » Seal housing chamber designed to prevent the accumulation of air in the critical area next to the mechanical seal
- » The pumps for G and N versions are certified for drinking water use (as per AS/NZS 4020)
- » Standard version for temperatures ranging from -30° to $+120^{\circ}\text{C}$
- » Pump body fitted with couplings for installing pressure gauges on both suction and delivery flanges
- » In-line ports with round flanges that can be coupled to counter-flanges, in compliance with EN 1092
- » Mechanical sturdiness and easy maintenance. No special tools required for assembly or disassembly

OPTIONS

- » The following versions are available:
 - F:** round flanges, in-line delivery and suction ports, AISI 304
 - T:** oval flanges, in-line delivery and suction ports, AISI 304
 - R:** round flanges, delivery port above the suction port, with four adjustable positions, AISI 304
 - N:** round flanges, in-line delivery and suction ports, AISI 316
 - V:** Victaulic® couplings, in-line delivery and suction ports AISI 316
 - C:** Clamp couplings (DIN 32676), in-line delivery and suction ports, AISI 316
 - K:** thread couplings, (DIN 11851), in-line delivery and suction ports, AISI 316
- » Balanced mechanical seal according to EN 12756 (ex DIN 24960) and ISO 3069, which can be replaced without removing the motor from the pump for 10, 15 and 22SV ($\geq 5,5$ kW) series
- » A second plug is available for 10, 15, 22SV series
- » Threaded, oval counter-flanges made of stainless steel are standard supply for the T versions
- » Round counter-flanges made of stainless steel are available on request for the F, R and N versions



IDENTIFICATION CODE - 1, 3, 5, 10, 15, 22SV SERIES

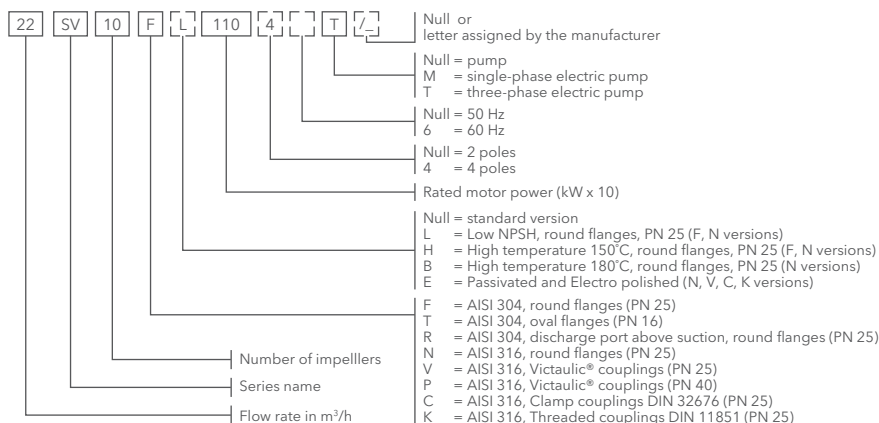

EXAMPLE: 22SV10F110T
SV series electric pump, flow rate 22 m^3/h , number of impellers 10, F version (AISI 304), round flanges, rated motor power 11 kW, 50 Hz frequency, three-phase.

VERTICAL MULTISTAGE PUMPS

PERFORMANCE CURVES AT 2900 RPM

↳ 1SV : 2-15 stages

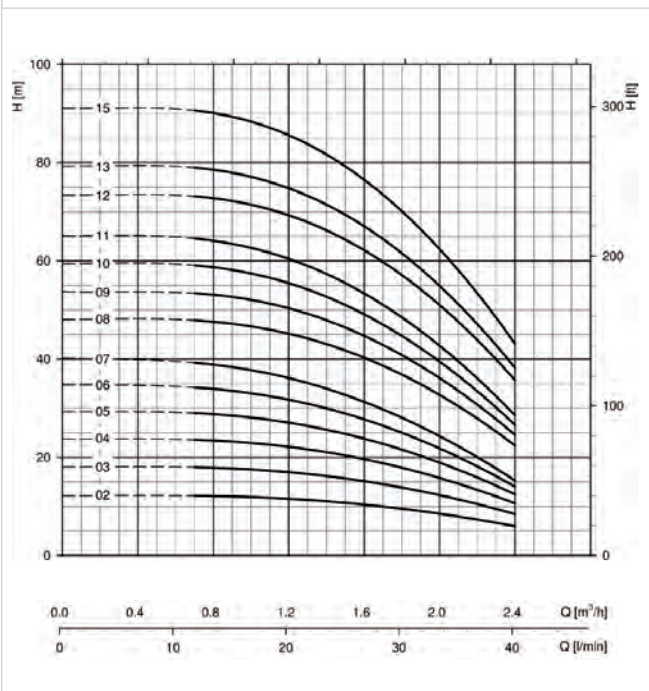

↳ 1SV : 17-37 stages

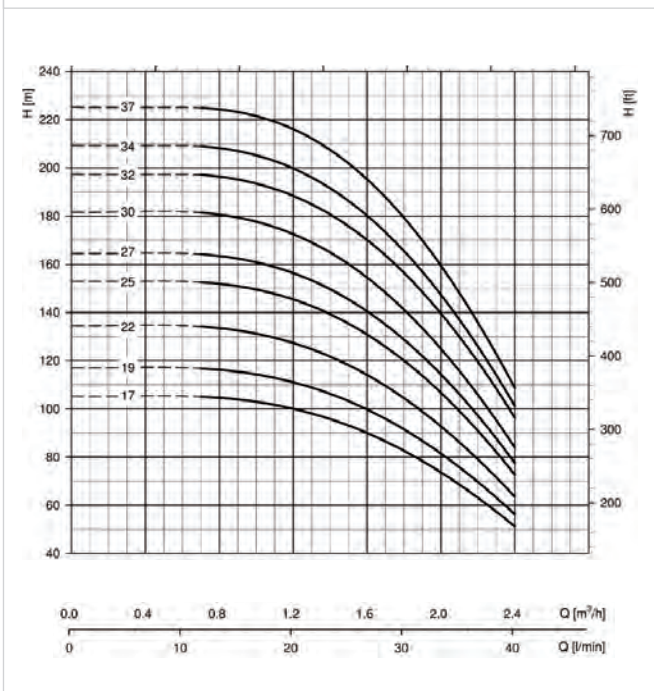

↳ 3SV

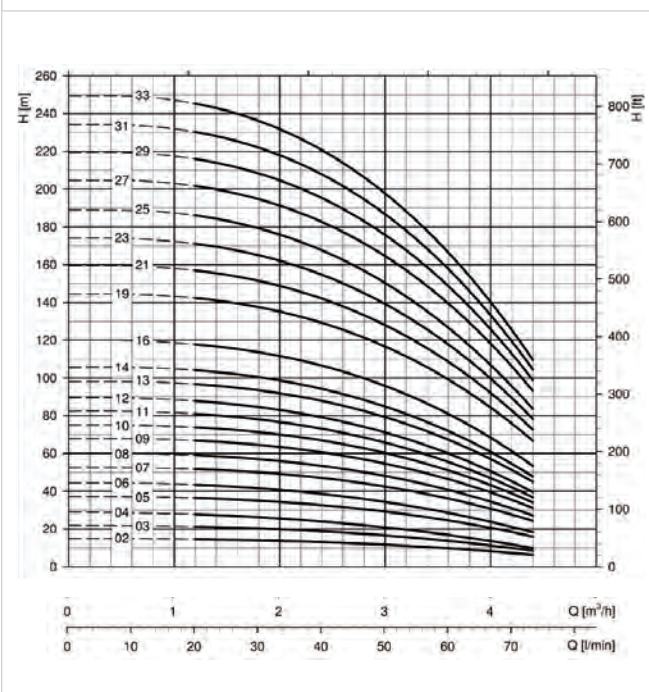

↳ 5SV

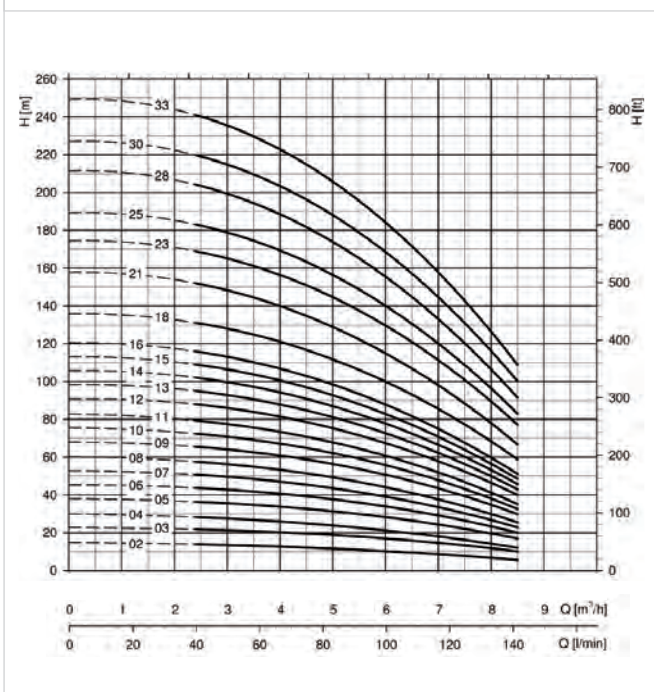

VERTICAL MULTISTAGE PUMPS

PERFORMANCE CURVES AT 2900 RPM

10SV

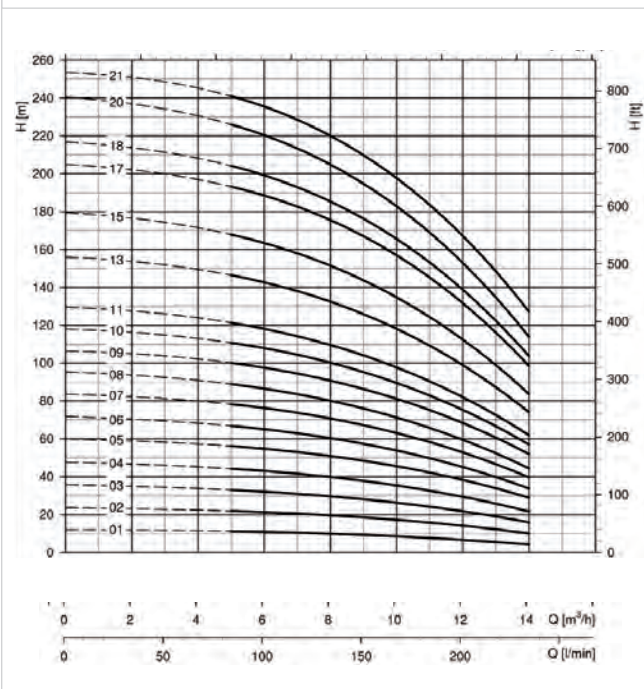

15SV

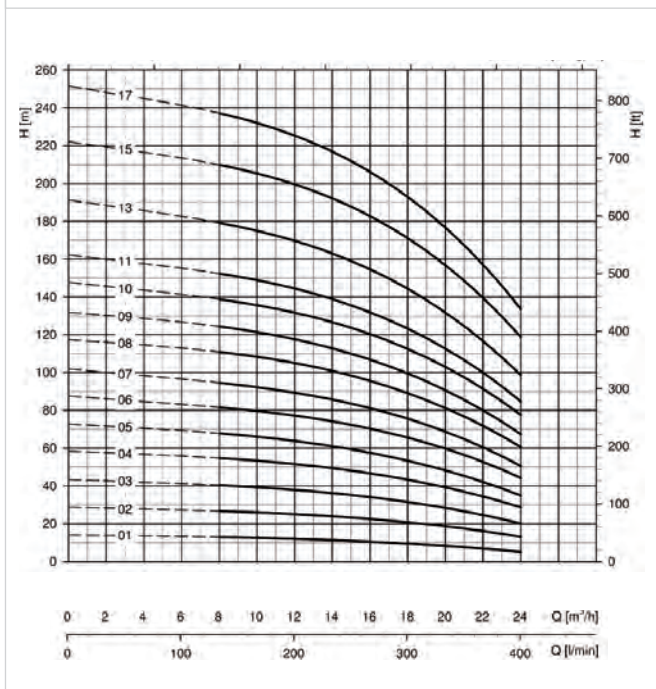

22SV

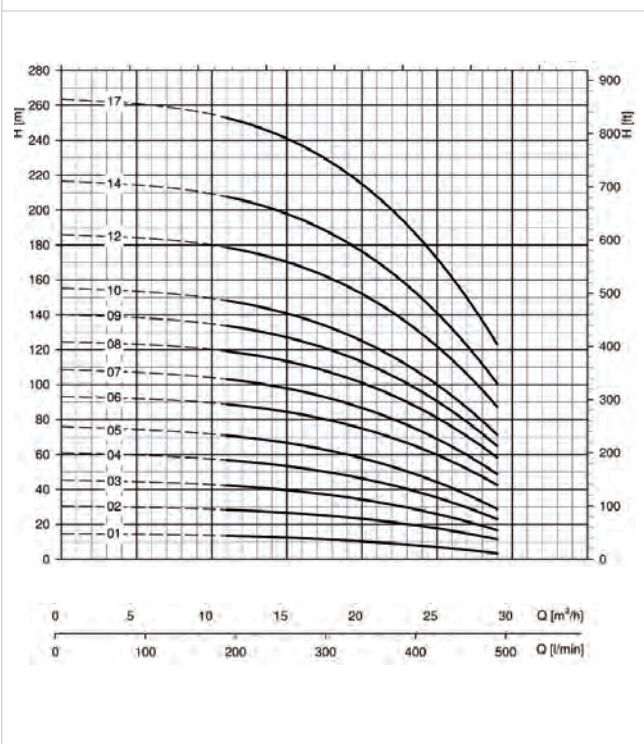

33SV

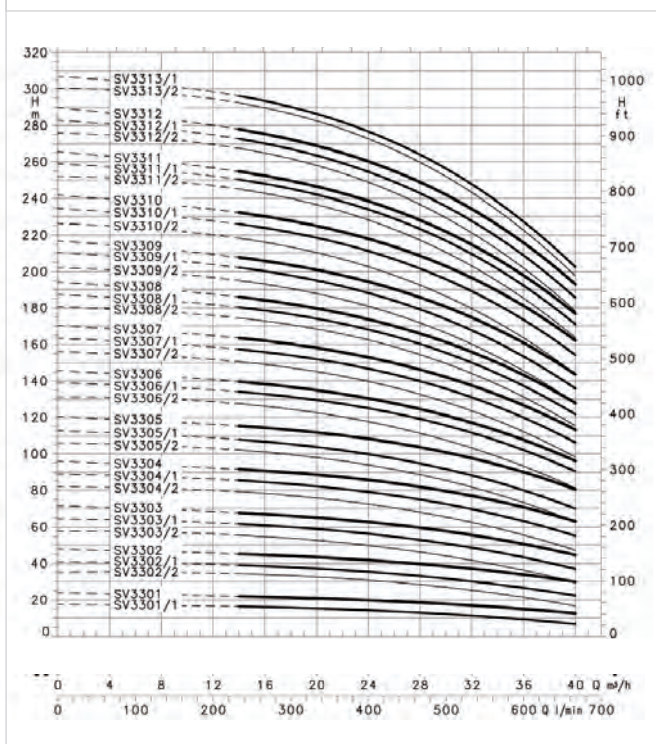

VERTICAL MULTISTAGE PUMPS

PERFORMANCE CURVES AT 2900 RPM

↳ 46SV

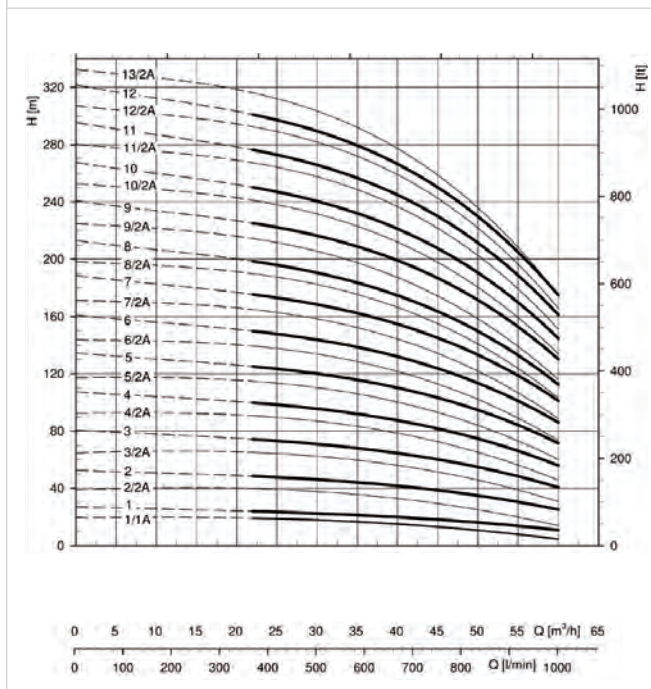

↳ 66SV

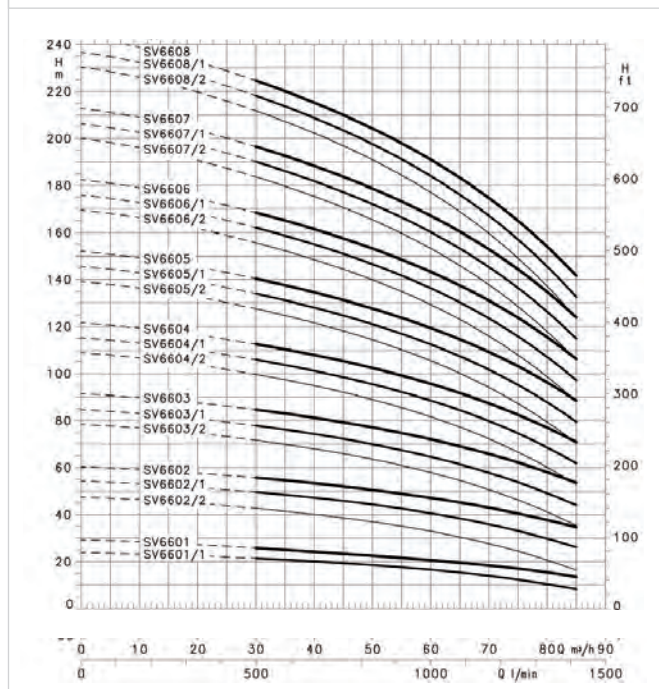

↳ 92SV

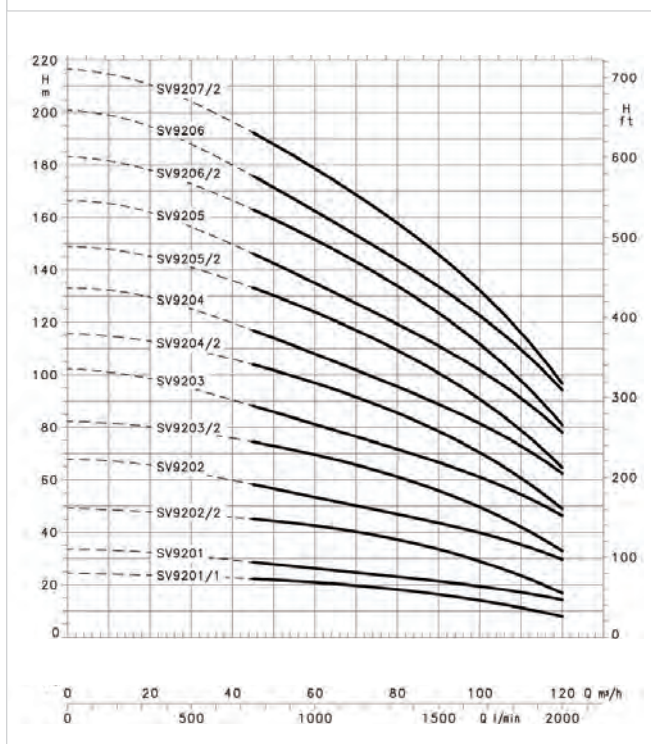

↳ 125SV

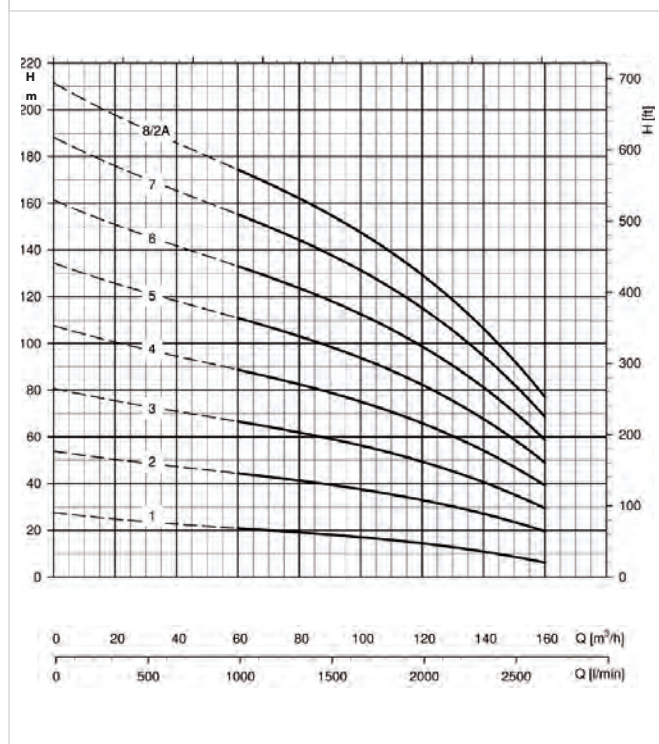

▾ HORIZONTAL MULTISTAGE PUMPS



High Efficiency
Horizontal
Multistage Pump

e-HM Series

▾ MARKET SECTIONS

- » Building Services
- » Industry

▾ APPLICATIONS

- » AS/NZS 4020 Compliant; Suitable for drinking water
- » Pressure boosting and water supply systems
- » Washing and cleaning industry including vehicle washing
- » Circulation of hot and cold liquids (water and glycol) for heating, cooling and airconditioning systems
- » Water treatment applications
- » Handling of moderately aggressive liquids
- » Food and beverage industries

▾ SPECIFICATIONS

▾ PUMP

- » Flow rate: up to 29m³/h
- » Head: up to 160m
- » Ambient temperature:
 - Three phase motor versions from -30°C to +50°C
 - Single phase motor versions from -30°C to +45°C (From -30°C to +40°C for 0,95kW motor).
- » Temperature of the pumped liquid:
 - +90°C for versions with Three phase motor uses as EN60335-2-41
 - +120°C for versions with Three phase motor and stainless steel impeller (HM..S, HM..N) uses other than EN60335-2-41
- » +60°C for versions with Single phase motor.
- » Maximum operating pressure:
 - 10 bar (PN 10) for pumps with Noryl™ impeller
 - 16 bar (PN 16) for pumps with stainless steel impeller and Q1BEGG or Q1Q1EGG mechanical seal (maximum liquid temperature +90°C)
- » Connections: Threaded for both suction and discharge manifold
- » Hydraulic performances compliant with ISO 9906: 2012 - Grade 3B
- » Available impellers include Noryl, 304SS and 316SS



PERFORMANCE CURVES AT 2900 RPM

▾ 1HM..P SERIES

OPERATING CHARACTERISTICS AT 50 Hz, 2 POLES

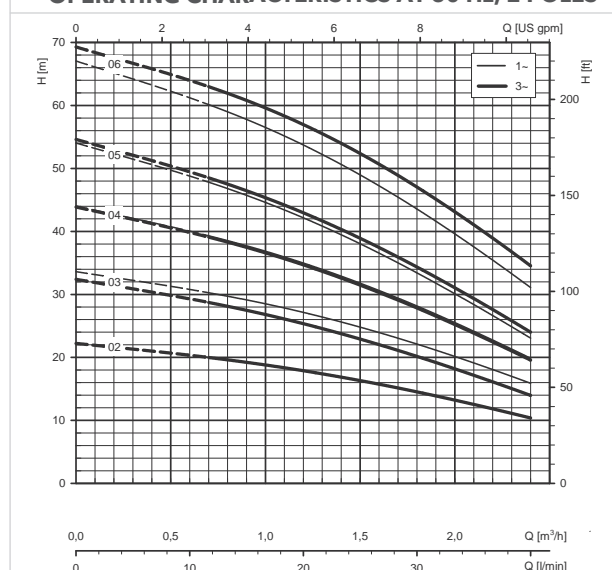

HORIZONTAL MULTISTAGE PUMPS

PERFORMANCE CURVES AT 2900 RPM

↳ **3HM..P SERIES**
OPERATING CHARACTERISTICS AT 50 Hz, 2 POLES

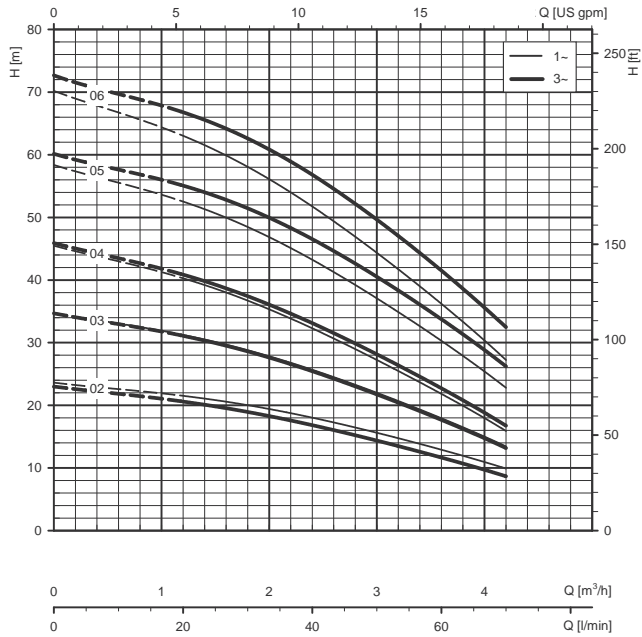

↳ **5HM..P SERIES**
OPERATING CHARACTERISTICS AT 50 Hz, 2 POLES

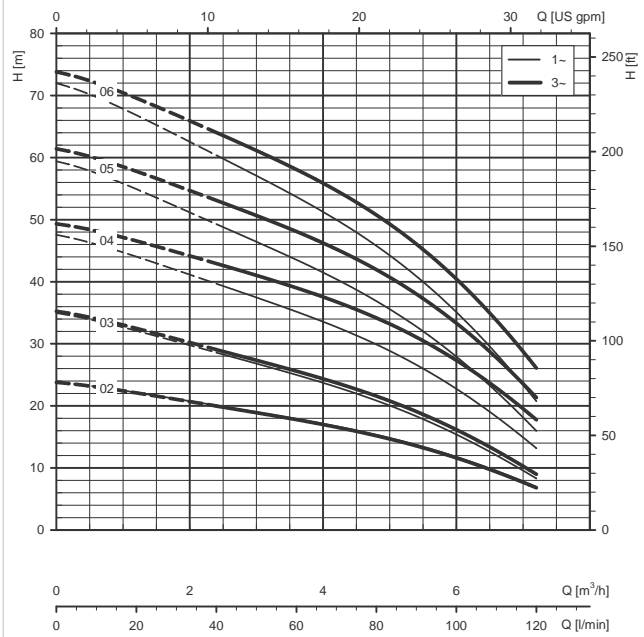

↳ **10HM..P SERIES**
OPERATING CHARACTERISTICS AT 50 Hz, 2 POLES

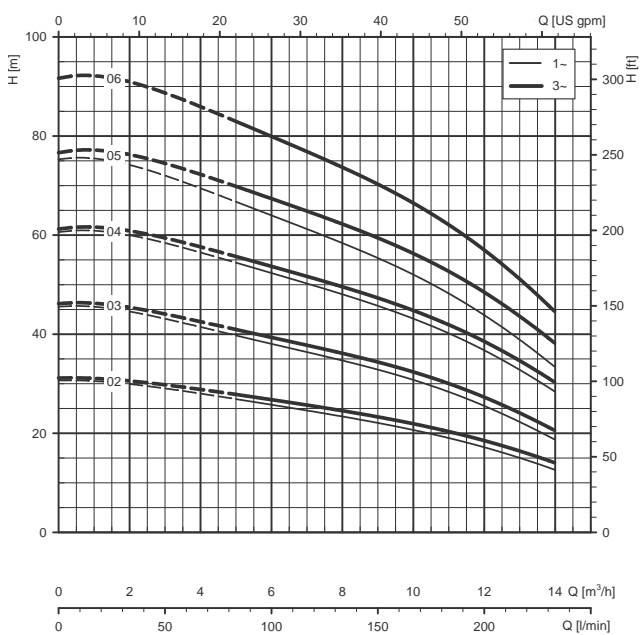

↳ **1HM..S - 1HM..N SERIES, (2 TO 9 STAGES)**
OPERATING CHARACTERISTICS AT 50 Hz, 2 POLES

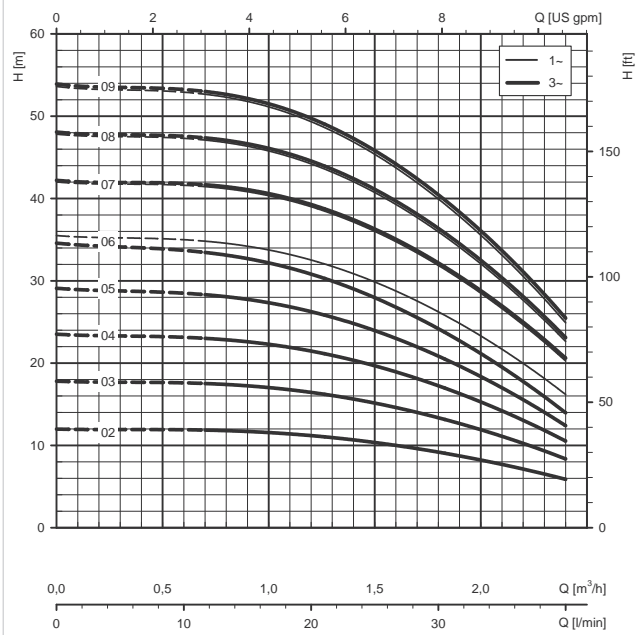

HORIZONTAL MULTISTAGE PUMPS

PERFORMANCE CURVES AT 2900 RPM

↳ **1HM..S - 1HM..N SERIES, (11 TO 25 STAGES)**
OPERATING CHARACTERISTICS AT 50 Hz, 2 POLES

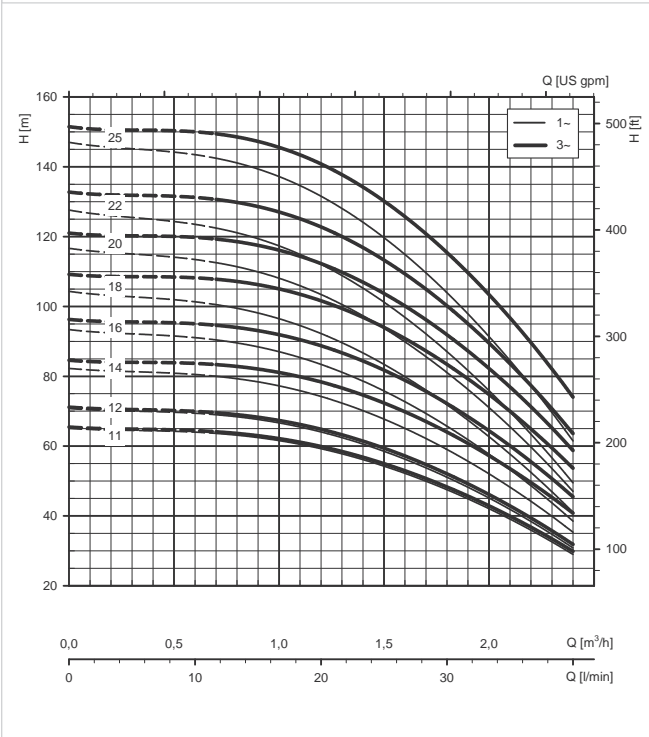

↳ **3HM..S - 3HM..N SERIES, (2 TO 10 STAGES)**
OPERATING CHARACTERISTICS AT 50 Hz, 2 POLES

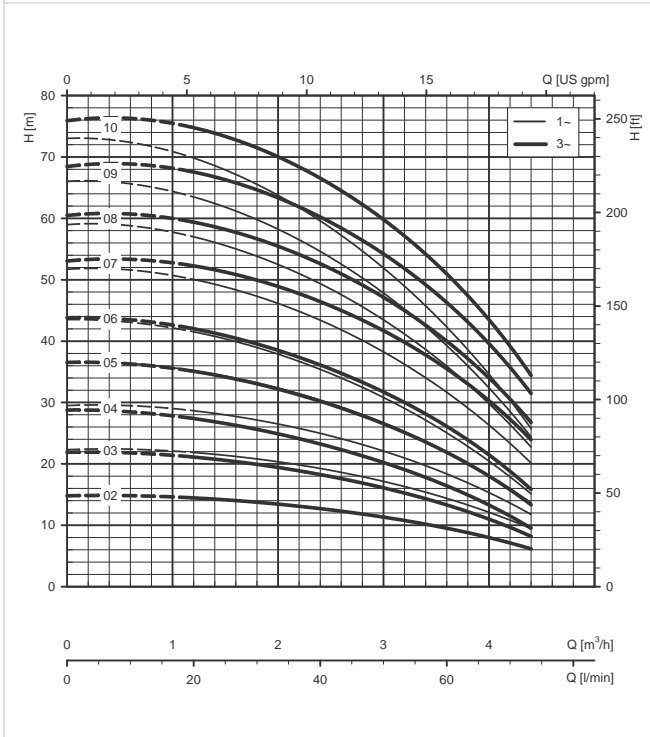

↳ **3HM..S - 3HM..N SERIES, (11 TO 21 STAGES)**
OPERATING CHARACTERISTICS AT 50 Hz, 2 POLES

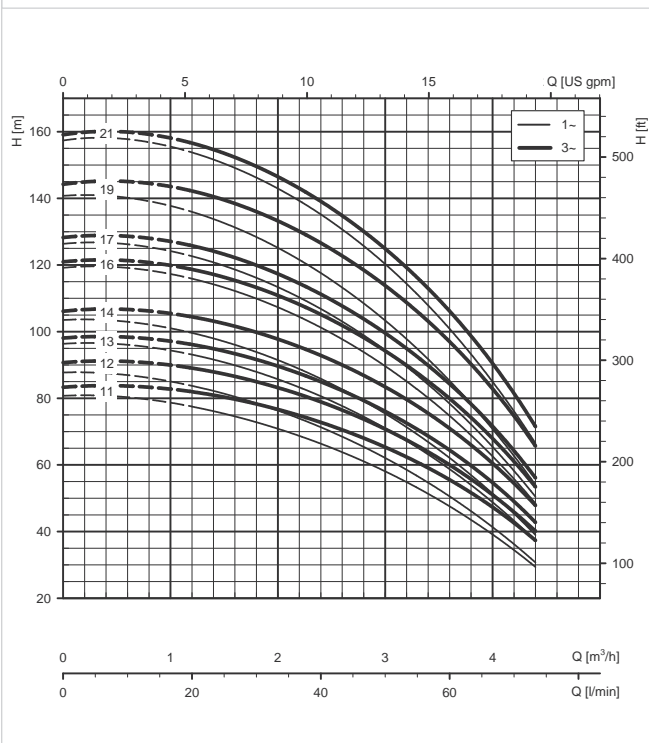

↳ **5HM..S - 5HM..N SERIES, (2 TO 9 STAGES)**
OPERATING CHARACTERISTICS AT 50 Hz, 2 POLES

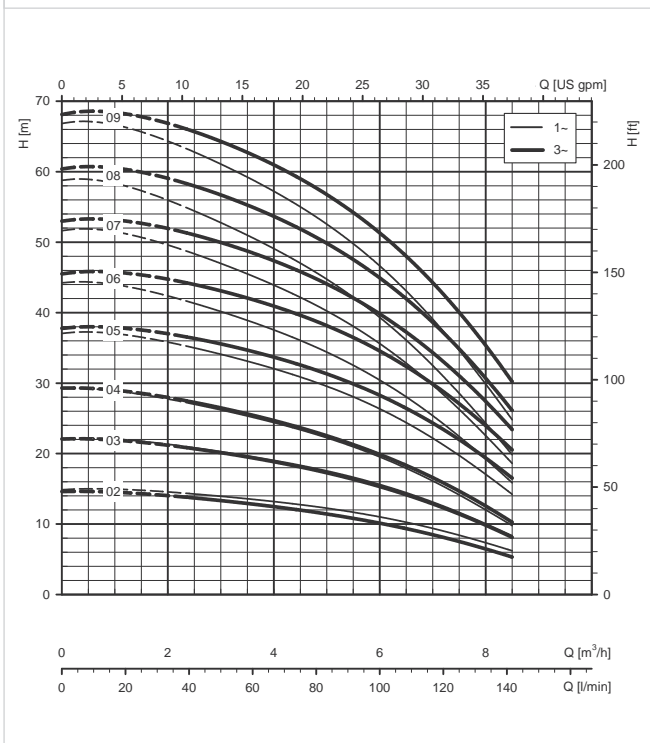

HORIZONTAL MULTISTAGE PUMPS

PERFORMANCE CURVES AT 2900 RPM

↳ **5HM..S - 5HM..N SERIES, (10 TO 21 STAGES)**
OPERATING CHARACTERISTICS AT 50 Hz, 2 POLES

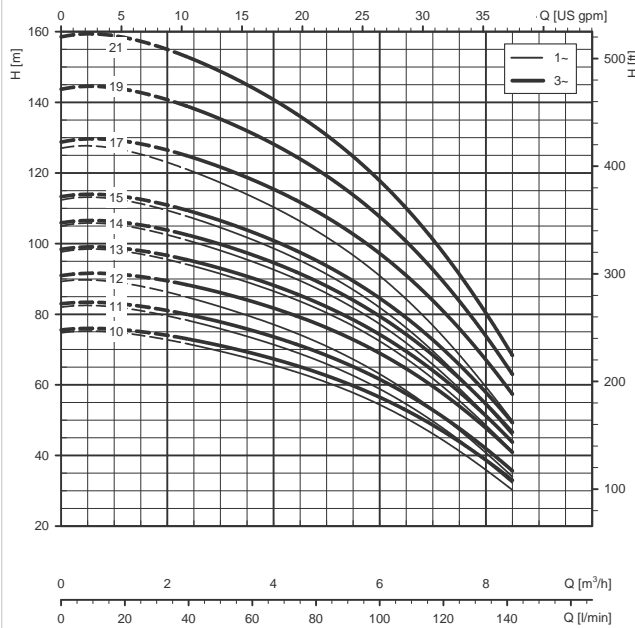

↳ **10HM..S - 10HM..N SERIES**
OPERATING CHARACTERISTICS AT 50 Hz, 2 POLES

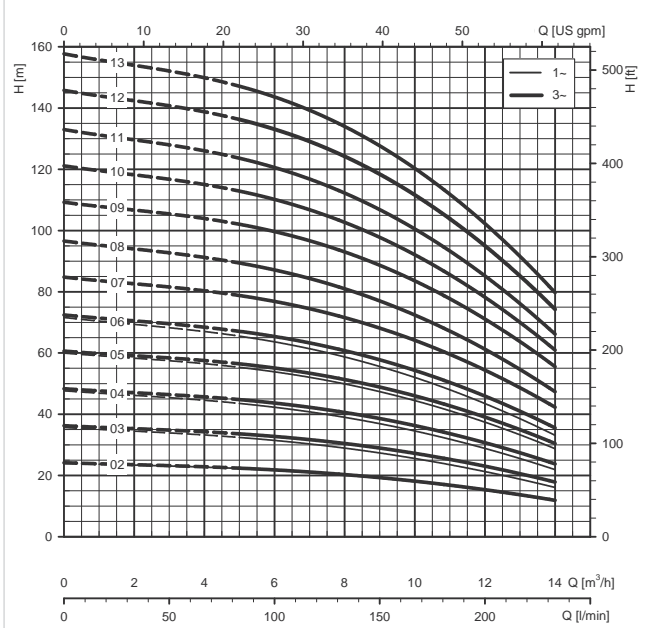

↳ **15HM..S - 15HM..N SERIES**
OPERATING CHARACTERISTICS AT 50 Hz, 2 POLES

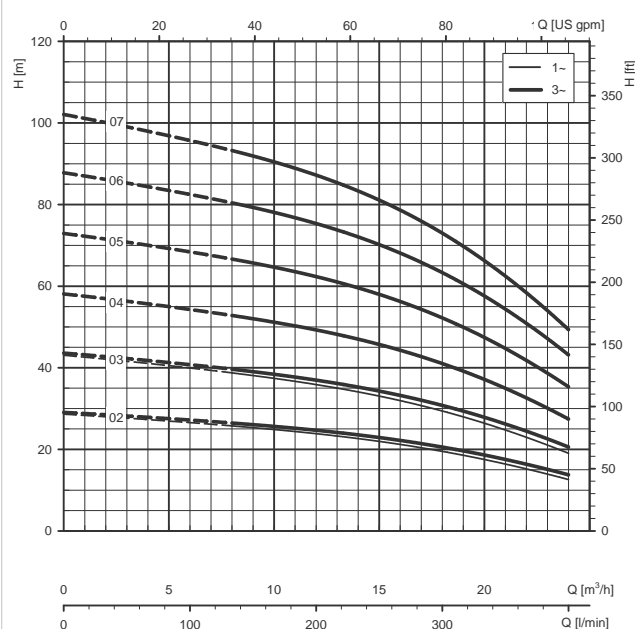

↳ **22HM..S - 22HM..N SERIES**
OPERATING CHARACTERISTICS AT 50 Hz, 2 POLES

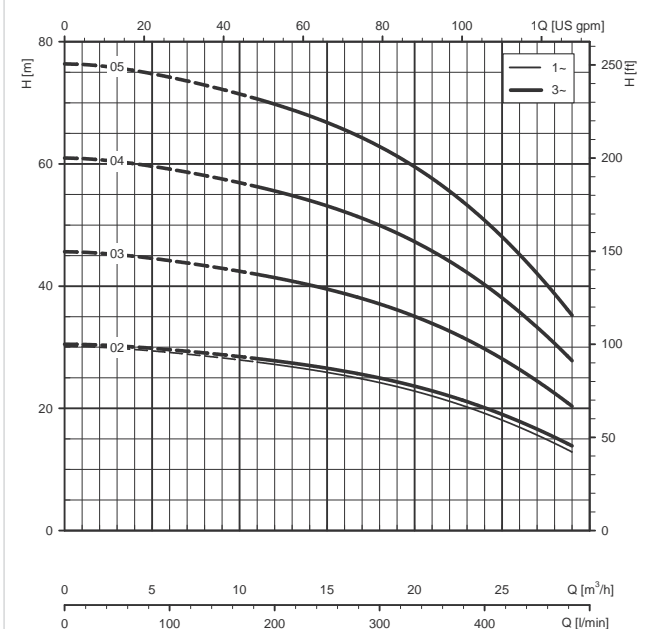

Wet Rotor Circulators For Commercial Applications

ecocirc XL / XLplus Series - Commercial

High efficiency circulators for commercial heating with electronically commutated permanent magnet technology.

PRODUCT DESCRIPTION

ecocirc XL and ecocirc XLplus circulator pumps are designed for circulating liquids in the following systems:

- » Hot water heating systems
- » Airconditioning and cooling systems
- » Domestic hot water systems

The pump can be also used for:

- » Solar systems
- » Geothermal systems
- » **AS/NZS 4020 Compliant; Suitable for drinking water (Stainless Steel version only)**

DUTY RANGE

- » Flow rate: up to 70 m³/h for single-head pumps and up to 135 m³/h for twin-head pumps
- » Head: up to 12m
- » Maximum power consumption: 1510 [W]
- » Temperature of pumped liquid: -10°C to +110°C
- » Ambient temperature during operations: 0°C to +40°C
- » Maximum operating pressure: 10 bar (PN 10)

FEATURES

- » Proportional pressure control
- » Constant pressure control
- » Constant speed
- » Night Mode
- » Constant temperature control (ecocirc XLplus only)
- » Differential temperature control (ecocirc XLplus only)
- » Additional operating modes for twin-head pumps including parallel and alternate operations (ecocirc XLplus only)
- » Dry run protection
- » Air purge
- » Plug for 100W motor size
- » Reading and settings of the pump by digital display and human machine interface with push buttons
- » Insulation shell for single-head pumps systems for heating
- » Integrated communication capabilities (Modbus and BacNet) for ecocirc XLplus



BENEFITS

- » Low power consumption; ecocirc XL and ecocirc XLplus are compliant to the ErP Directive
- » Easy to set-up
- » User-friendly human machine interface with digital display
- » Control panel with push buttons to change circulator status
- » Operating status visualization
- » Warning and alarm visualization
- » Errors and working log history visualization (ecocirc XLplus only)
- » Dry running detection
- » Multi-pump functions
- » External control and monitoring (ecocirc XLplus only)
- » Module for wireless communication (ecocirc XLplus only)

CIRCULATORS



Circulators for Heating Applications

ecocirc Premium

Impressively simple, that's the shaftless spherical motor design. It requires only one single bearing, which is even self re-aligning but does not require any shaft at all. That significantly reduces the number of costly and complicated parts.

PRODUCT DESCRIPTION

All Lowara ecocirc PREMIUM come standard with three control options, a plug that does not require a tool for assembly, and even a multi-display mounted on the end cap:

» Multi-Display

The automatically alternating display shows either the currently consumed power, the pump head or the flow rate.

» Three stepless control options

- stepless fixed speed
- automatic proportional pressure control $\Delta p-v$
- automatic constant pressure control $\Delta p-c$

» Plug, no tools required for assembly

An easy and quick electrical connection. The female plug is compatible also with male plugs from previously on site installed third-party circulators.

By turning the stator via the screw ring, the plug can be fixed in any position, making an installation even in the hardest and tightest environment easy.



SPECIFICATIONS

- » Motor design: Electronically commutated, shaftless spherical motor design with permanent magnetic rotor
- » Max. system pressure: 10 bar
- » Electric connection: 200 - 240 Volt, 50 / 60 Hertz
- » Power consumption:
 - ecocirc xx-4: 4 - 23 Watt
 - ecocirc xx-6: 4 - 42 Watt
- » Accepted liquids:
 - Heating water VDI 2035
 - Water/Glycol mixtures*
- » Magnetite resistance accepted: Anti-Block-Technology
- » Temperature range: -10°C **to $+110^{\circ}\text{C}$
- » Energy efficiency: ErP 2015 ready
- » Motor protection class: IP 44
- » Insulation class: F

* check hydraulic performance with more than 20 % glycol

**non-freezing

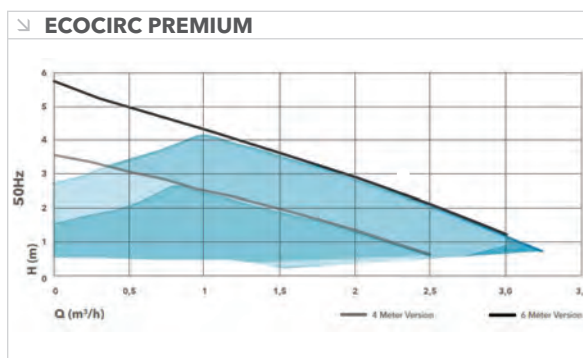

CIRCULATORS

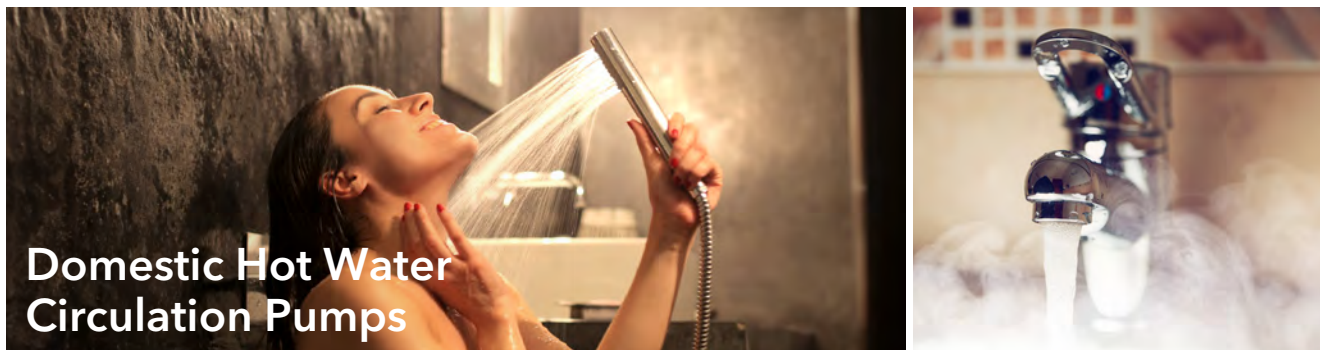

Domestic Hot Water Circulation Pumps

ecocirc Pro

The new high efficiency domestic hot water pumps with automatic air venting function and thermal insulation shell.

SPECIFICATIONS

- » Motor Type: Shaftless spherical motor with highly efficient ECM permanent magnet technology
- » Max. power consumption:
 - PRO 15-1: 3-9 Watts
 - PRO 15-1 R: 6 Watts
 - PRO 15-1 RU: 8 Watts PRO 15-3: 4-27 Watts
- » Max. system pressure: 10 bar
- » Electrical connection: 230V, 50Hz
- » System temperature: +2°C to +65°C
- » Setting range for electronic control thermostat: 20-70°C (optional)
- » Protection type/Insulation class: IP 44/F
- » Pump media: Domestic hot water

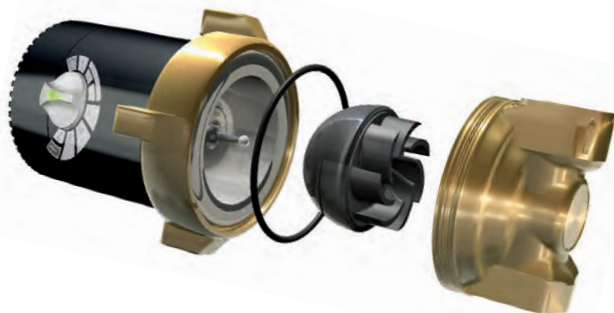

MODEL	PART NUMBER	VERSION	PUMP HOUSING LENGHT (mm)	CONNECTIONS	FOR UNION FITTINGS	NON-RETURN VALVE	TIMER	ELECTRONIC CONTROL THERMOSTAT (20-70°C)
605005020	ecocirc PRO 15-1/65	1 meter	65	RP 1/2"	AV 1/2" x 1/2"	integrated		
605005100	ecocirc PRO 15-1/65 R							•
605005140	ecocirc PRO 15-1/65 U						•	
605005180	ecocirc PRO 15-1/65 RU						•	•
605005060	ecocirc PRO 15-1/110	1 meter	110	G 1 1/4" and RP 1/2"	AV 5/4" x 3/4" and AV 1/2" x 1/2"	integrated with shut-off valve		•
605005120	ecocirc PRO 15-1/110 R						•	
605005160	ecocirc PRO 15-1/110 U						•	
605005200	ecocirc PRO 15-1/110 RU						•	•
605005040	ecocirc PRO 15-3/65	3 meter	65	RP 1/2"	AV 1/2" x 1/2"	integrated		
605005080	ecocirc PRO 15-3/110		110	G 1 1/4" and RP 1/2"	AV 5/4" x 3/4" and AV 1/2" x 1/2"	integrated with shut-off valve		

CIRCULATORS

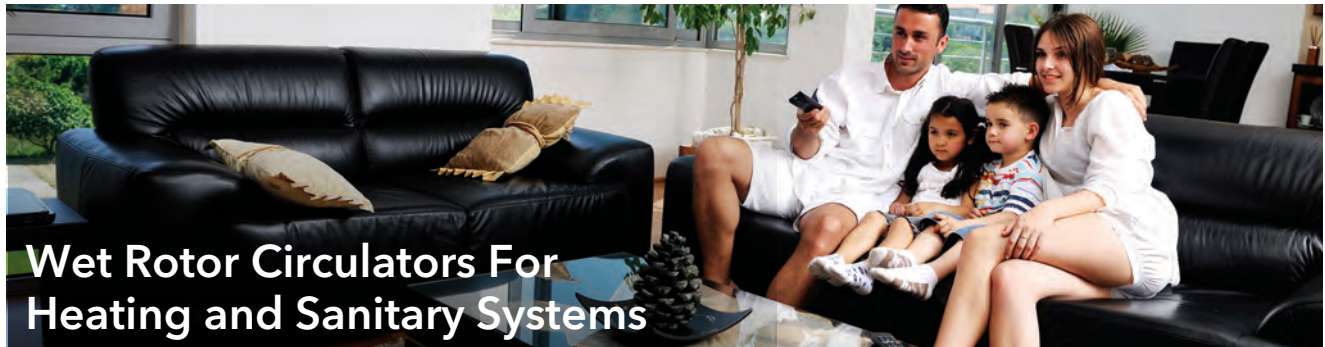

Wet Rotor Circulators For Heating and Sanitary Systems

TLCN - TLCHN Stainless Steel Series - Domestic

Threaded wet rotor circulator pumps for residential, light commercial heating and sanitary systems

FEATURES

- » The pump is easily bled by simply opening the venting screw placed in the centre of the top cover. Liquid will fill the circuit allowing the pump to reach optimum operational conditions more quickly
- » The integration of the terminal box in the motor not only reduces the physical space needed, but also makes it easier to install and connect the pump
- » The screw on the top cover gives you direct access to the motor shaft for easy unblocking of rotor using a simple screwdriver
- » Reduced noise level thanks to ceramic shaft and bearings
- » **AS/NZS 4020 Compliant; Suitable for drinking water**



SPECIFICATIONS

TLCN - TLCHN are residential and light commercial circulators for the circulation of hot water in domestic hot water systems and high flow / high head domestic hot water systems. TLCN - TLCHN have the following features:

- » Flow rate: up to 12m³/hr
- » Head: up to 12m
- » Temperature of pumped liquid: +2°C to +110°C
- » Maximum operating pressure: 10 bar (PN 10)
- » Protection Class: IP 44
- » Insulation Class: F
- » Pump Body: Stainless Steel
- » Maximum Power: 80W
- » Power Supply: 230V

ACCESSORIES / OPTIONS

- » Insulation shell
- » Pipe unions

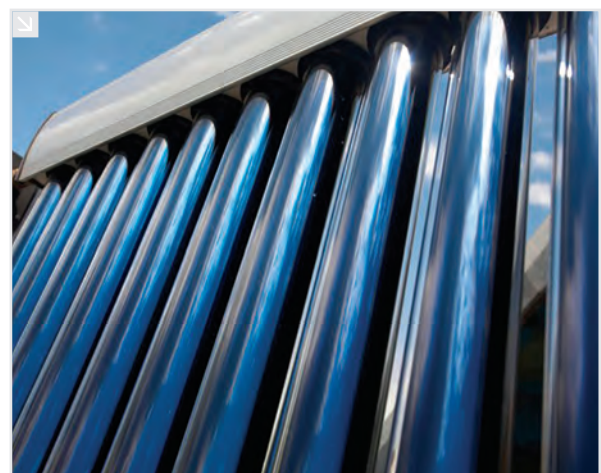

CIRCULATORS

Taking hydraulic & motor efficiency to a new level

e-LNE

Higher hydraulic efficiencies & motor performances, extended range for a wide range of applications.

SPECIFICATIONS

- » Sizes: DN 32, DN 40, DN 50, DN 65, DN80, DN 100, DN125, DN150, DN 200 & DN 250
- » Power: 0.75 - 37 kW (2-pole); 0.25 - 90 kW (4-pole)
- » Heads up to: 95 m
- » Flows up to: 900 m3/h
- » Pressure class: PN16
- » Temperature of pumped liquid: -25°C to +120°C, extended temperature, version up to +140°C Variable
- » speed option: Hydrovar

FEATURES

- » High efficiency
New designed high efficiency hydraulics and IE3 motors set the basis for very low operation costs.
- » Long service life & easy maintenance
Robust design, different bearing frame sizes and stainless steel replaceable wear rings ensure a long service life. The e-LNE series is also designed for easy maintenance & all service points are easy reachable to reduce downtime.
- » Adapt to needs
In many applications the need for water is always varying. By equipping these In-line pumps with a Hydrovar pump controller, the duty is always exactly where it should be. And it pays off: reducing the speed by 50% reduces the power consumption by 85%.
- » Exactly the right configuration
With material options spanning from cast iron body in GG25 cast iron, stainless steel, Bronze impellers with choice of mechanical seal options the e-LNE is the right solution for 1000's of liquids.
- » Hot or cold
The standard e-LNE can handle liquid temperatures from -25°C up to +120°C and the extended temperature version up to +140°C.



MATERIAL TABLE

COMPONENT	MATERIAL
Pump housing	CAST IRON (GG25)
Impeller	Cast Iron, Fabricated Stainless Steel, Bronze, or Cast Stainless Steel
Elastomers	EPDM, FPM (other materials available on request)
Mechanical Seal	Carbon, Silicon Carbide/EPDM (other options available on request)
Configuration Options	Extended Shaft or Stub Shaft

» For curves and selections please visit www.xylect.com

CIRCULATORS

PERFORMANCE CURVES AT 2900 RPM

HYDRAULIC PERFORMANCE RANGE AT 50 Hz, 2 POLES

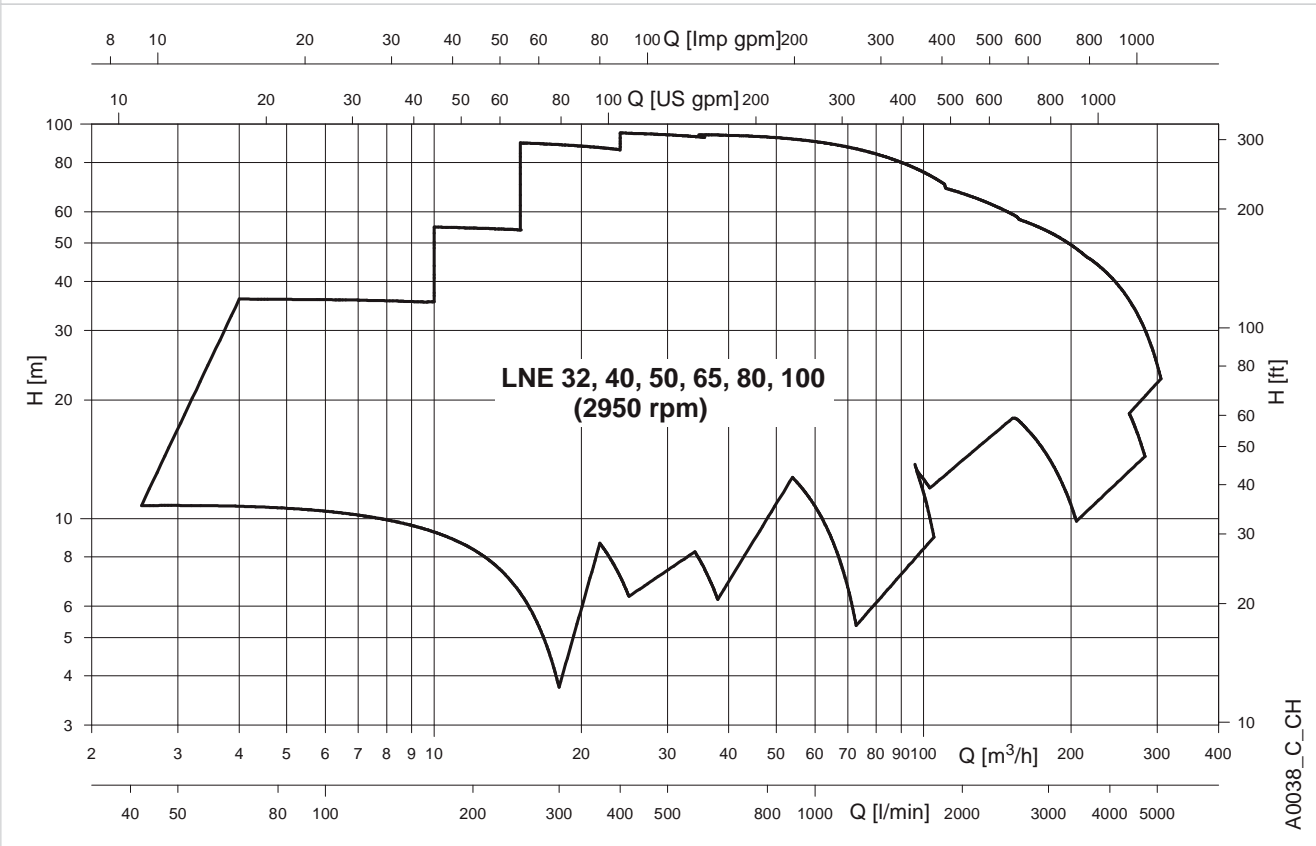

HYDRAULIC PERFORMANCE RANGE AT 50 Hz, 4 POLES

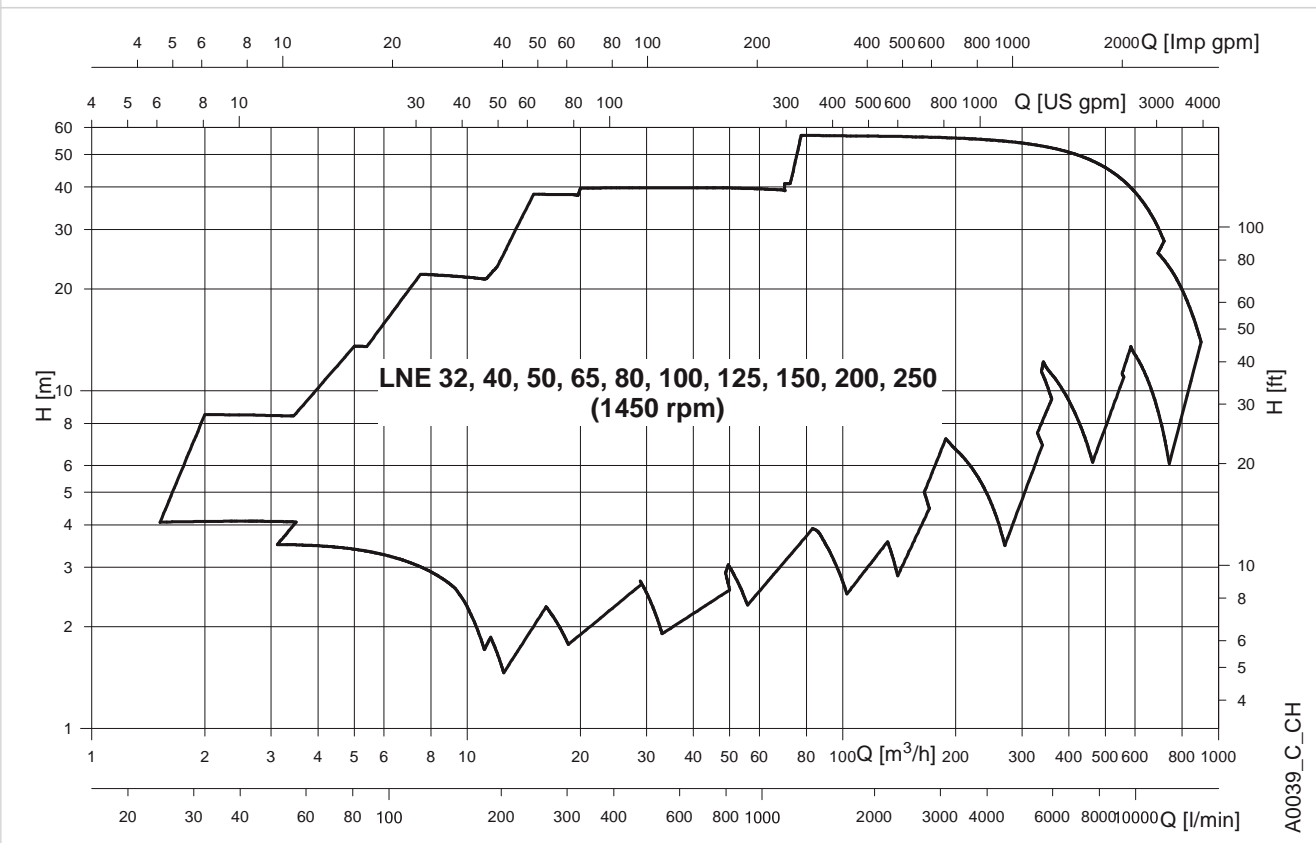

BOREHOLE PUMPS & MOTORS



4" Submersible Borehole Pump

e-GS Series

The Lowara e-GS pump for 4" wells has an enhanced hydraulic efficiency to set the basis for lower operational costs and premium efficiency.

The abrasion resistant construction, combined with floating impellers ensures optimum resistance to wear making this one of the best pumps on the market for sand handling capabilities. The stainless steel structure of the pump ensures high resistance to corrosion with a built in non-return valve and cable guard attachment.

The upper and lower supports are made of precision-cast stainless steel and the hexagonal pump shaft guarantees an effective impeller drive.

APPLICATIONS

- » Water supply
- » Irrigation systems
- » Pressure boosting
- » Stock watering

SPECIFICATIONS

- » Delivery up to 22 m³/h
- » Head up to 310 m
- » Power supply both single and three-phase 50 and 60 Hz
- » Power from 0.25 kW up to 7.50 kW
- » Maximum pump overall diameter (including cable cover) 99 mm
- » Maximum permissible quantity of sand: 150 g/m³.
- » 1GSL - 2GS - 4GS - 6GS versions: Rp 1 1/4" delivery port.
- » 8GS - 12GS - 16GS versions: Rp 2" delivery port.
- » Temperature of pumped liquid: up to 35°C
- » Maximum immersion depth: 300 m



FEATURES

- » Abrasion resistant construction. The front wear plate, combined with the floating impeller, ensures optimum resistance to abrasion
- » A non-return valve is fitted in the discharge to ensure no back flow or water hammer to the pump, thus safeguarding impellers, diffusers and motor
- » The upper and lower supports are made of precision cast stainless steel, ensuring resistance to corrosion, durability and sturdy coupling to the motor



e-GS SERIES MOTOR SELECTION CHART

Series	Motor Size kW											
	Model	.25	.37	.55	.75	1.1	1.5	2.2	3.0	4.0	5.5	7.5
1GSL	02	03	05	07	11	15						
2GS	02	03	05	07	11	15	22	30				
4GS		03	05	07	11	15	22	30	40			
6GS			05	07	11	15	22	30	40R, 40	55R, 55		
8GS				07	11	15	22	30	40	55R, 55	75R, 75	
12GS					11	15	22	30	40	55R, 55	75	
16GS						15	22	30	40	55R, 55		

MATERIAL TABLE

COMPONENT	MATERIAL
Sleeve, cable cover and grid	(AISI 304) STAINLESS STEEL
Shaft, diffuser casing joint	(AISI 304) STAINLESS STEEL
Upper bracket and lower bracket	(AISI 303) STAINLESS STEEL PRECISION CASTING
Impeller and diffuser	TECHNOPOLYMER
Upper bearing	POLYURETHANE
Valve packing	NITRILE RUBBER

BOREHOLE PUMPS & MOTORS

PERFORMANCE CURVES AT 2900 RPM

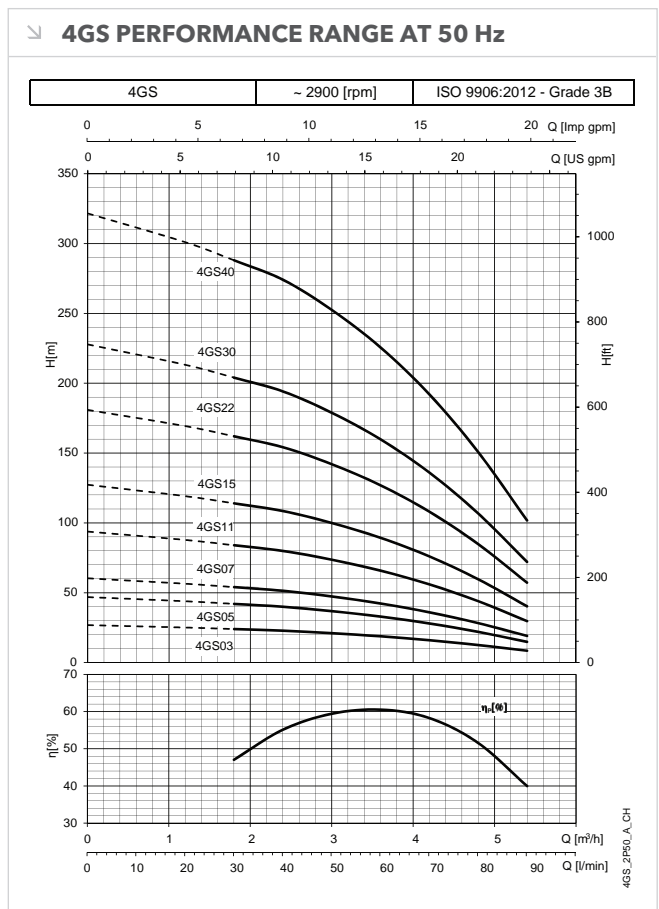
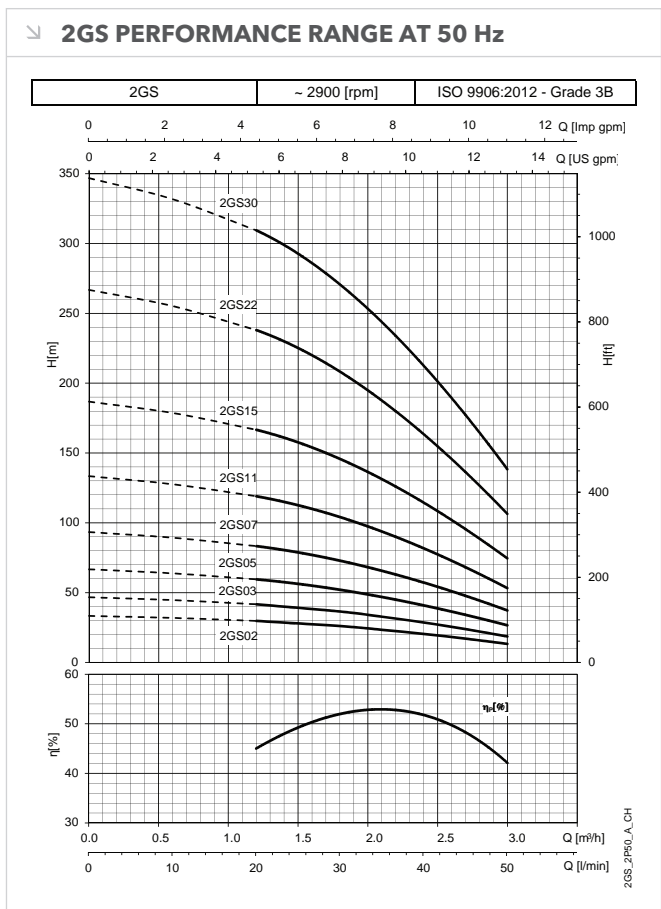
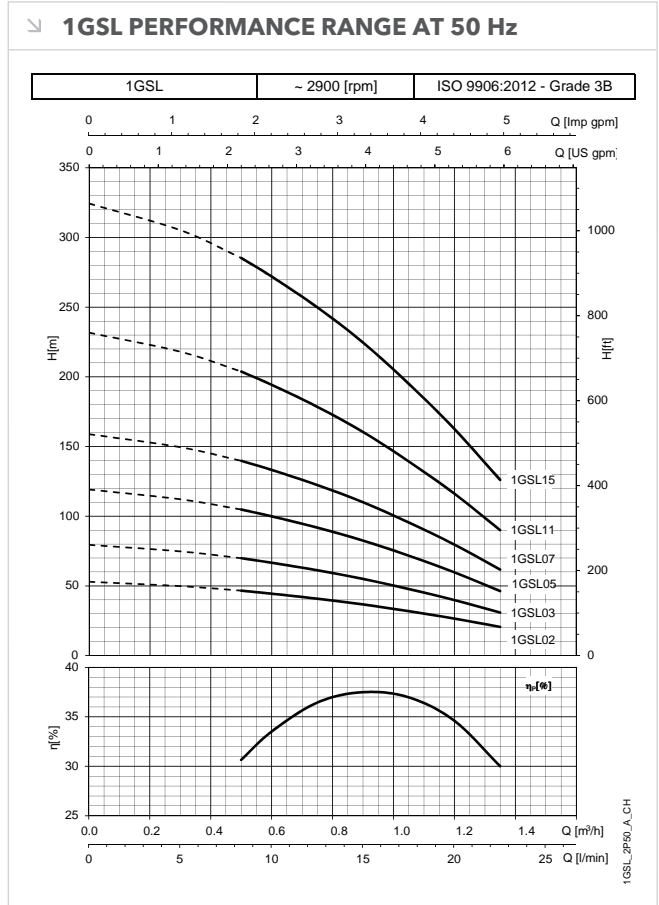
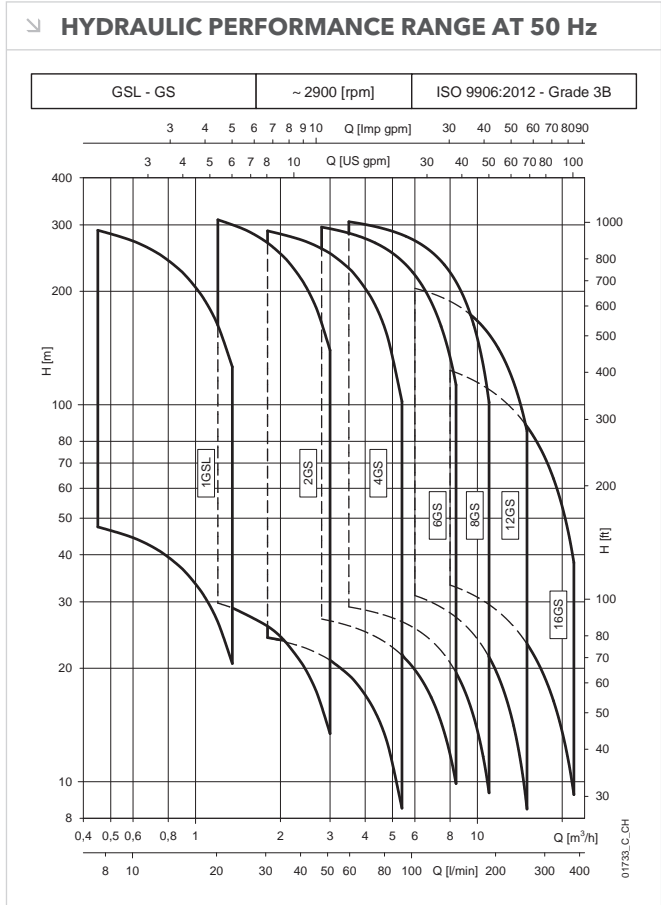

These performances are valid for liquids with density $\rho = 1.0 \text{ Kg/dm}^3$ and kinematic viscosity $\nu = 1 \text{ mm}^2/\text{sec}$.

BOREHOLE PUMPS & MOTORS

PERFORMANCE CURVES AT 2900 RPM

6GS PERFORMANCE RANGE AT 50 Hz

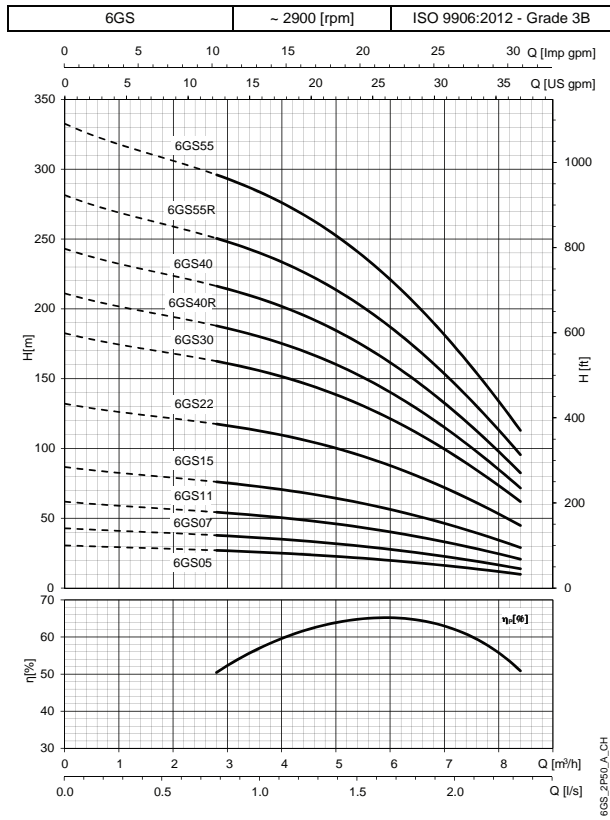

8GS PERFORMANCE RANGE AT 50 Hz

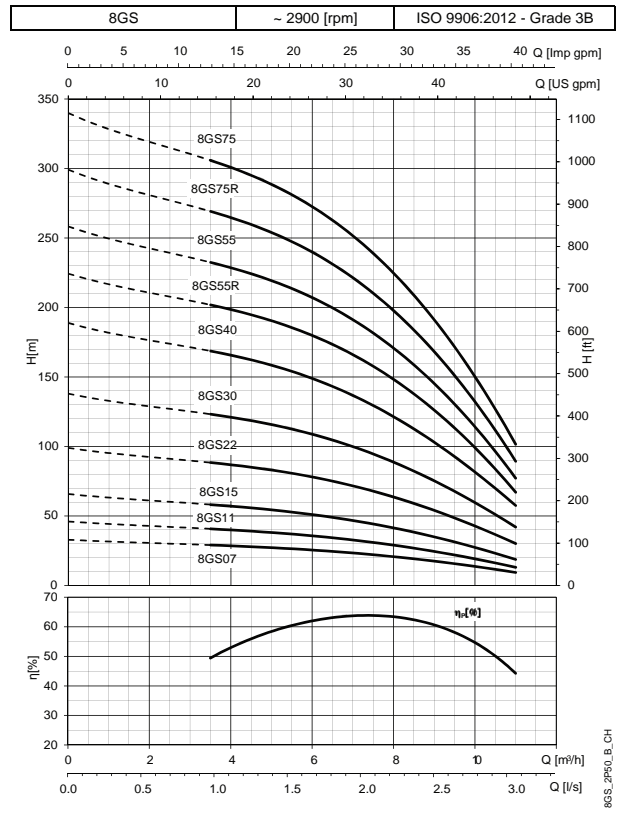

12GS PERFORMANCE RANGE AT 50 Hz

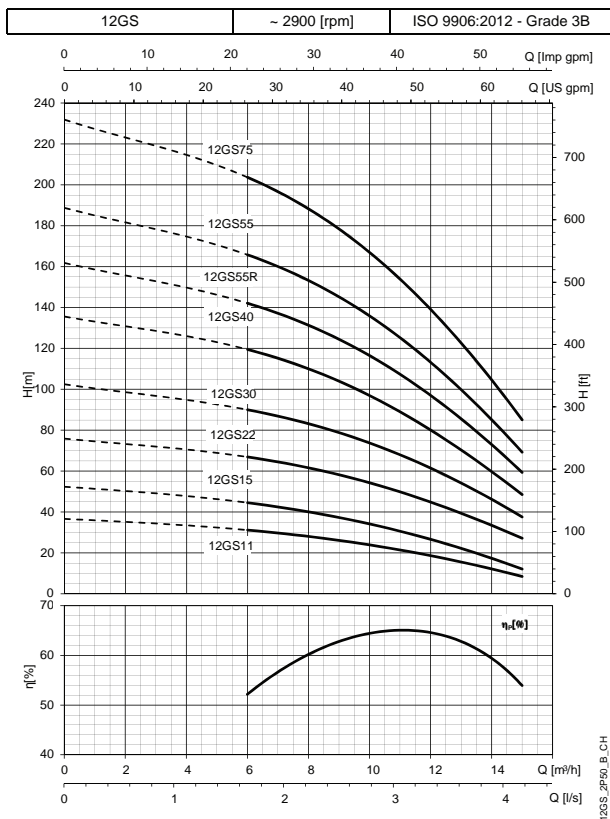

16GS PERFORMANCE RANGE AT 50 Hz

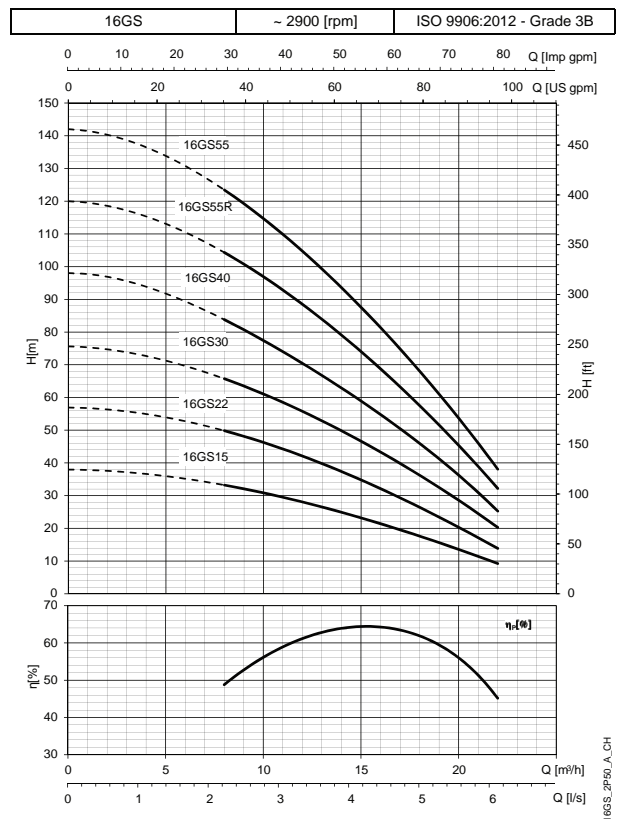

These performances are valid for liquids with density $\rho = 1.0 \text{ Kg/dm}^3$ and kinematic viscosity $\nu = 1 \text{ mm}^2/\text{sec}$.

BOREHOLE PUMPS & MOTORS

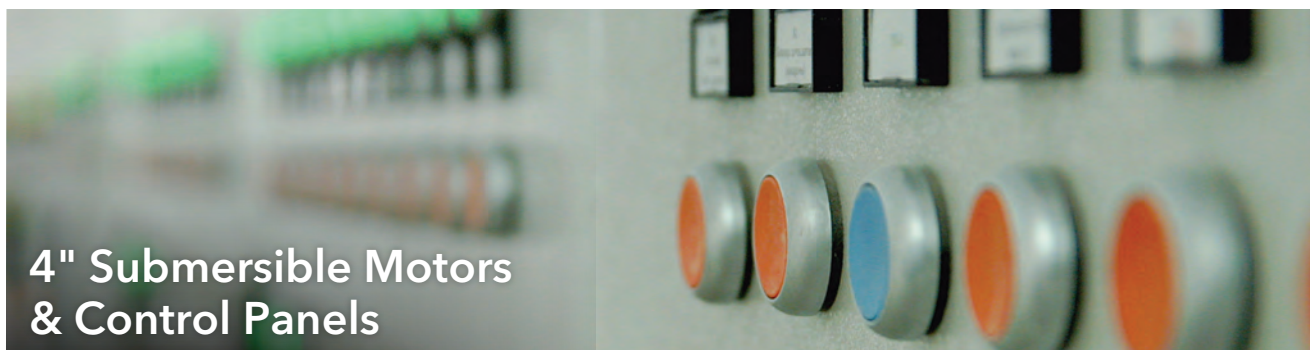

4" Submersible Motors & Control Panels

4OS Series Motors

Submersible 4" oil filled rewindable motors available with full AISI 304 stainless steel outer casing. Available as 2-wire or 3-wire single phase motors, or three phase versions.

▾ SPECIFICATIONS

- » All outer components in AISI 304 stainless steel
- » Class F insulation
- » NEMA standard shaft extension and coupling
- » IP68 protection class
- » Maximum water temperature: 35°C
- » Maximum immersion depth: 150m
- » 2-wire single phase version up to 1.1kW with in-built capacitor
- » 3-wire single phase version up to 4kW
- » Three phase version up to 7.5kW

▾ FEATURES

- » Internal lubrication suitable for contact with foodstuffs
- » Mechanical seal protected by sand guard
- » Power supply cable with extractable connector



QPC Control Panel

Single phase electric panel for control and protection of 3-wire single phase submersible borehole pumps.

▾ SPECIFICATIONS

- » Main switch with manual-reset thermal protection and power indicator light.
- » Supply voltage: 1 x 230 V \pm 10%.
- » Frequency: 50 Hz.
- » Power: 0.37 to 2.2 kW.
- » Direct motor start.
- » Protection class: IP54.
- » Ambient temperature: -5 to +40 °C
- » Plastic enclosure.
- » Incorporated capacitor.

Larger size single phase controllers available upon request (up to 4kW).



BOREHOLE PUMPS & MOTORS



6" Submersible Borehole Pump

Z6 - ZN6 Series

The Z6-ZN6 Series is designed for use in 6" wells. The head and motor support of this lightweight and sturdy pump are cast in stainless steel, as are the shaft sleeves, ensuring long lasting reliability and efficiency.

The pump has a high sand handling capability which make the Z6-ZN6 series suitable for use in aggressive environments such as water supply from deep wells or irrigation over large areas such as golf courses.

SPECIFICATIONS

- » Delivery up to 78 m³/h
- » Head up to 700 m
- » Power requirements from 0.55kW to 55kW
- » Maximum standard pump overall diameter (including one cable guard) 142 mm
- » Maximum permissible quantity of sand: 100 g/m³.
- » Maximum immersion depth: 350m
- » Standard Z612 - Z616 - Z622 versions: Rp 2 ½" delivery port.
- » Standard Z631 - Z646 - Z660 versions: Rp 3" delivery port.
- » Available in High Pressure configurations
- » Temperature of pumped liquid: 60°C (but limited to motor design)
- » All Z6-ZN6 pumps are suitable to be coupled to NEMA standard motors
- » Power requirements from 0.55kW - 55kW

FEATURES

- » Sturdy and lightweight, easy to disassemble and corrosion-resistant
- » Impellers and diffusers are made of stainless steel
- » Stainless steel supports
- » Stainless steel non-return valve
- » Upper bearing of tungsten carbide
- » Shaft bearings of special polyurethane
- » Elastomer EPDM
- » Available in all 316SS construction



APPLICATIONS

- » Water supply
- » Irrigation systems
- » Pressure boosting
- » Mine dewatering



BOREHOLE PUMPS & MOTORS

PERFORMANCE CURVES AT 2900 RPM

↳ Z612: 1 to 19 Stages

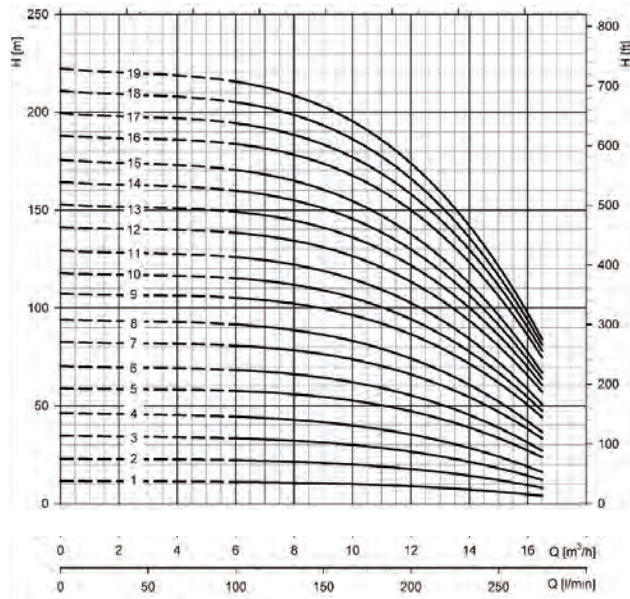

↳ Z616: 1 to 18 Stages

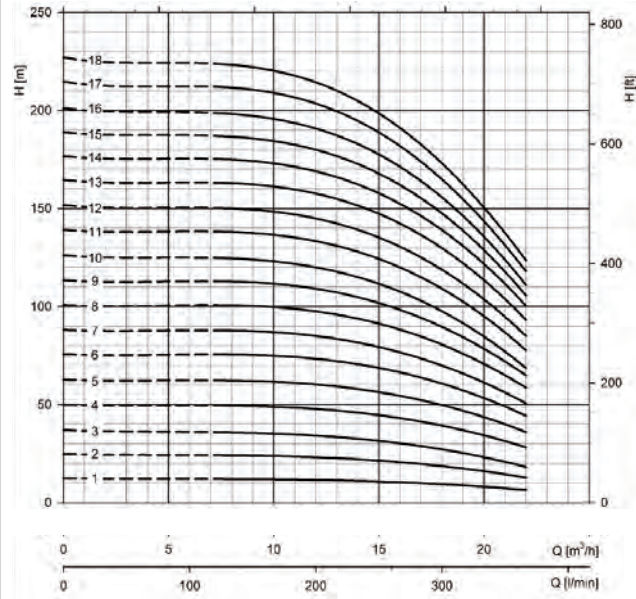

↳ Z622: 1 to 17 Stages

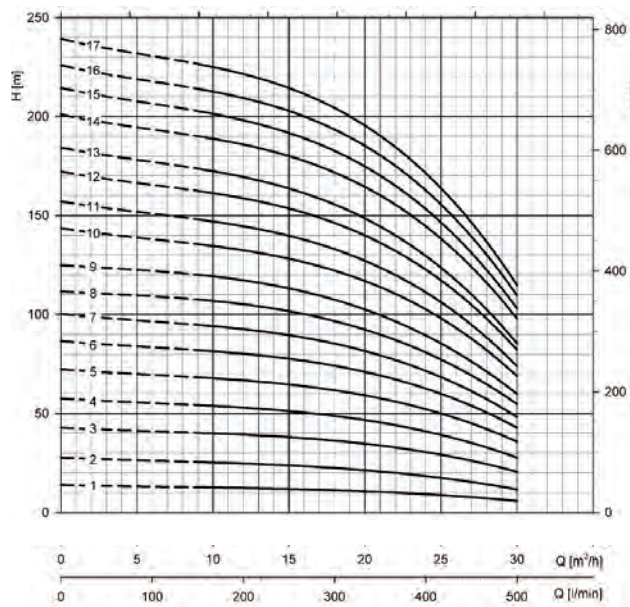

↳ Z631: 1 to 15 Stages

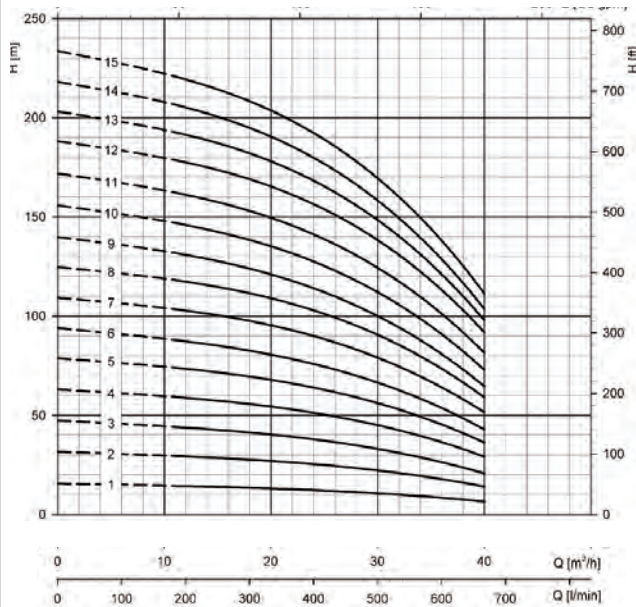

BOREHOLE PUMPS & MOTORS

PERFORMANCE CURVES AT 2900 RPM

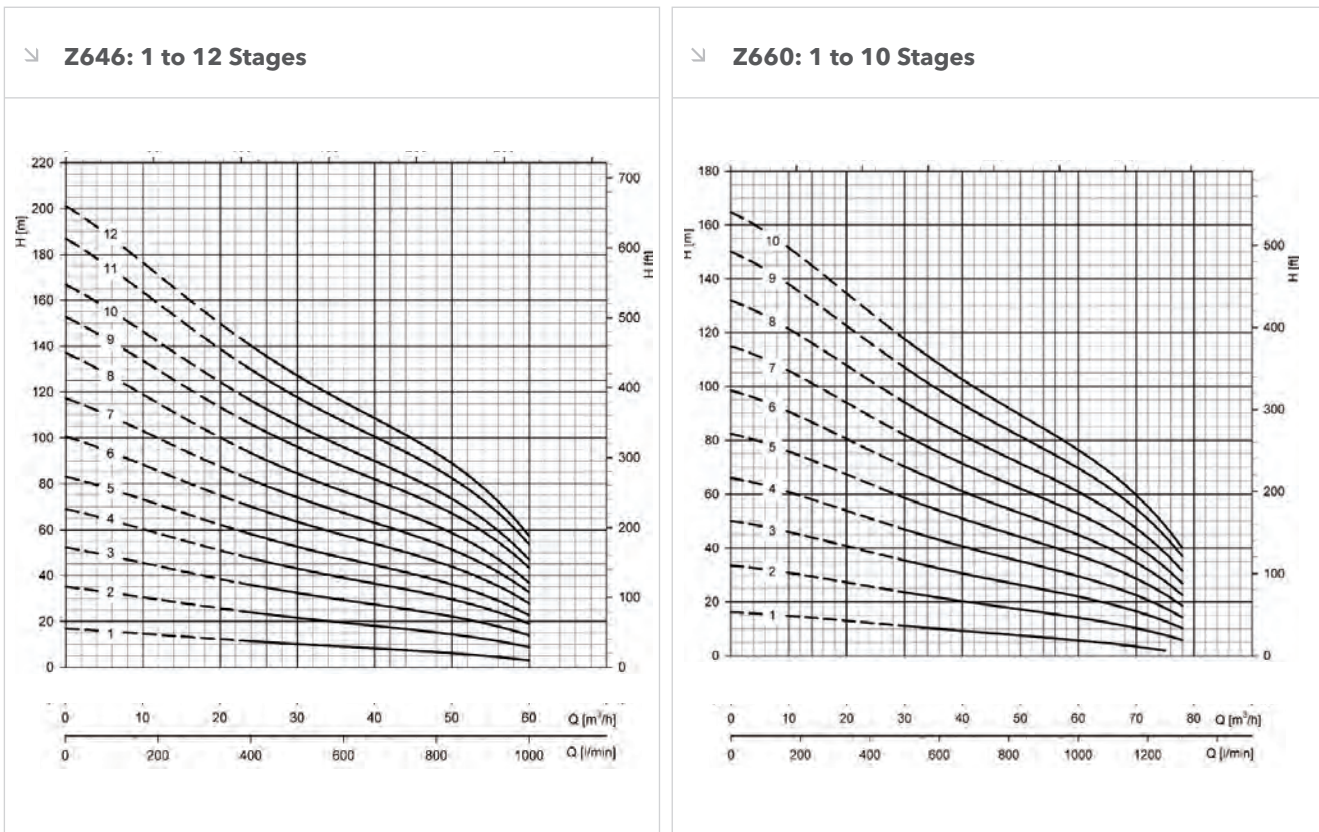

For ease of display, only the first grouping of performance stages shown.
 Refer to the comprehensive Z Series catalogue for higher stage performance curves.

	Z612	Z616	Z622	Z631	Z646	Z660
Max Stages / Max Head	60 / 692m	56 / 701m	50 / 674m	43 / 628m	37 / 437m	32 / 380m

IDENTIFICATION CODE (PUMP)

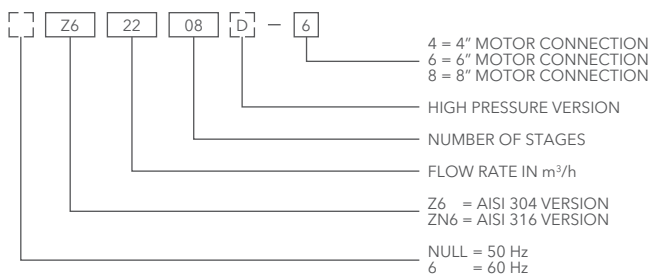

IDENTIFICATION CODE (ELECTRIC PUMP)

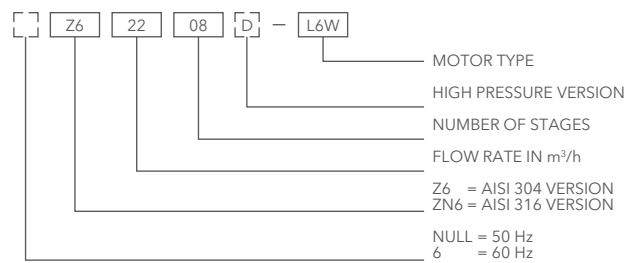

BOREHOLE PUMPS & MOTORS



Z8 - ZR8, Z10 - ZR10, Z12 - ZR12 Series

This series of robust submersible pumps are highly efficient and designed for ease of servicing. Optimized hydraulic design with high quality castings. Standard manufacture in cast 304 stainless steel equivalent to assist operation in corrosive environments. Available also in "ZR" as cast duplex stainless steel for more corrosive applications.



APPLICATIONS

- » Water supply from deep bores, rivers and reservoirs
- » Pressure boosting and water distribution in civil and commercial systems
- » Firefighting and washing systems
- » Dewatering and water level control
- » Irrigation for crop and turf
- » Mine dewatering

SPECIFICATIONS

- » Flows: Z8 to 180m³/hr, Z10 to 350m³/hr, Z12 to 520m³/hr
- » Heads: Z8 to 550m, Z10 to 545m, Z12 to 450m
- » Motor fitting to 6" & 8" NEMA, and 10" & 12" with keyed shaft
- » Pump Max OD:
 - Z8 one cable guard; 198mm, with two cable guards; 204mm
 - Z10 with one cable guard; 255mm, with two cableguards; 271mm
 - Z12 with one cable guard; 290mm, with two cable guards; 302mm
- » Pump Discharges: Z8 of 5", Z10 of 6", Z12 of 8"
- » Max permissible suspended solids of 50gm/m³, up to 100gm/m³ if wear tolerated

FEATURES

- » High efficiency of hydraulics to ensure minimum energy use
- » New "dynamic" wear ring reduces hydraulic losses to a minimum, keeps the high efficiency characteristics over time and the pump from blocking during stand-by periods
- » Guide bearings on all the stages ensure resistance to wear and guarantee constantly reliable hydraulics
- » In built non-return check valve with integrated spring for positive return
- » Impeller and diffusers made of cast stainless steel
- » Delivery casing made of cast stainless steel
- » Suction support and shaft made of cast stainless steel
- » Suitable for horizontal operation

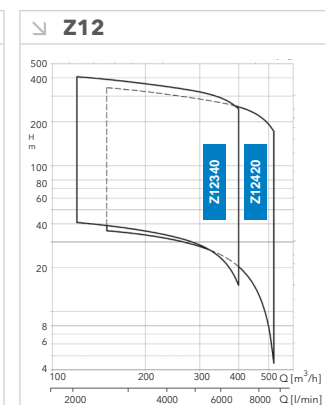
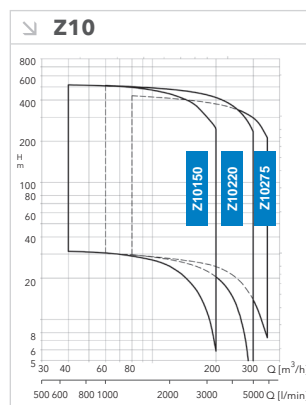
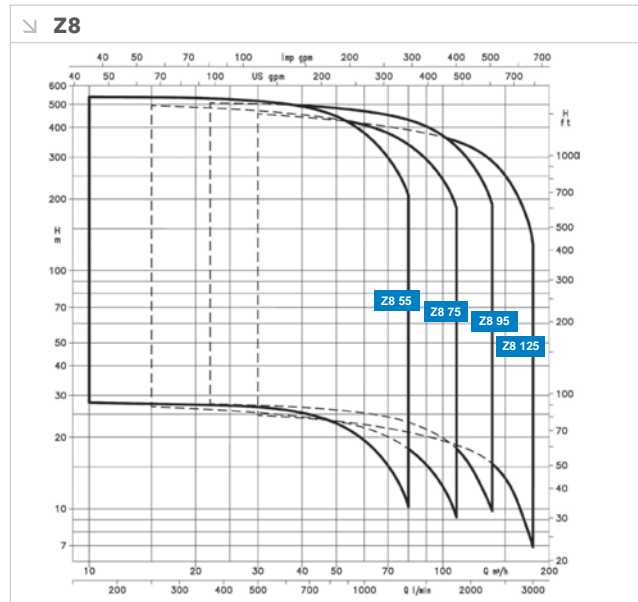

BOREHOLE PUMPS & MOTORS

6", 8", 10" & 12" Submersible Motors

Robust submersible motors suitable for use within boreholes, wells and applications when combined with borehole pumps. Water filled rewindable stator design. Standard construction is for 304SS motor sleeve with cast iron ends. The 6" and 8" series have NEMA shaft and coupling dimensions. The 10" and 12" have borehole pump suitable dimensions.

L6C & L6CN Series

- » Voltage 380-415V/50Hz +/- 6%
- » Power range 4kW - 45kW
- » Protection class: IP68
- » 304SS motor sleeve with Cast Iron upper and lower brackets.
- » Full 316SS outer motor casing (N version).
- » Maximum immersion depth of 250m.
- » Maximum water temperature of 35°C.
- » Axial thrust with Kingsbury type bearings: 16000N from 4kW to 22kW & 27000N from 30kW to 45kW
- » Power supply cable with extractable connector
- » N version supplied with SiC/SiC seals as standard.

L6W & L8W Series

- » Voltage 380-400V/50Hz +/- 10%
- » Power range L6W: 4kW to 37kW
L8W: 37kW to 110kW
- » Protection Class: IP 68
- » Maximum submergence: 350m
- » Class Y insulation on standard products
- » Maximum water temperature: +30°C
- » Axial load thrust with Kingsbury bearing;
L6W: 6,000N to 22kW and 30,000N to 37kW
L8W: 50,000N
- » Maximum starts per hour at regular intervals
L6W: 15, L8W: 10
- » Mechanical shaft seal incorporating sand guard
- » Compensating bellows for internal liquid thermal expansion

L10W & L12W Series

- » Voltage 380-400V/50Hz +/- 10%
- » Power range L10W: 110kW to 150kW
L12W: 185kW to 300kW
- » Protection Class: IP 68
- » Maximum submergence: 350m
- » Class Y insulation on standard products
- » Maximum water temperature: +30°C
- » Axial load thrust with Kingsbury bearing;
L10W: 65,000N
L12W: 65,000N
- » Maximum starts per hour at regular intervals
L10W: 8
L12W: 4
- » Mechanical shaft seal incorporating sand guard
- » Compensating bellows for internal liquid thermal expansion



L6W - L12W CONSTRUCTION OPTIONS

- » All 316 SS version
- » Duplex version

L6W - L12W OPTIONAL FEATURES

- » High temperature winding for up to +60°C (check de-rating over +45°C)
- » Special voltages
- » PT 100 temperature protection sensors and controllers
- » Silicon carbide mechanical seal

▾ VARIABLE SPEED DRIVE



HYDROVAR®

The 5th generation of the HYDROVAR is now more efficient than ever and easier to install and operate, making it the ideal variable speed pump drive for new and retrofit applications.

The HYDROVAR works with any standard AC motor and can be direct mounted or wall mounted to support any manufacturer's pump. The built-in application software makes it the easiest drive to commission, program and operate, enabling virtually any configuration of pumps. Backward compatibility assures the latest generation HYDROVAR will work seamlessly with existing systems.

Integrated pump functions provide protection for the pump and motors, and the embedded THDi filter further extends equipment life by improving the quality of energy from the grid. All of this means reliable energy savings of up to 70% from a compact, easy-to-use drive suited for nearly any application.



▾ FEATURES

- » Automated Commissioning
 - Automated start-up menu
 - Larger LCD display
 - Preprogramming for standard motors
 - 28 language sets
- » Expanded ranges:
 - 1,5 kW (2 HP) 3ph 380-460V
 - From 1,5kW (2 HP) to 11kW (15 HP) 3ph 208-240V
 - Up to 4 kW (5 HP) 1ph 208-240V
- » BACnet and Modbus as a standard for seamless BMS integration
- » Advanced motor control to reduce heating and extend the lifetime of the motor
- » Embedded THDi filter for better electricity quality from the grid, extending the lifetime of the equipment
- » Standard multi-pump capability of up to 8 pumps with no single failure point
- » Premium card option for extended I/O
- » Backward compatibility to existing HYDROVAR Gen 4 products



Burj Khalifa opened in 2010. Xylem special designed variable speed booster sets distribute 1000 m³ of water every day all the way up to the top floor of the 800 m building.

VARIABLE SPEED DRIVE

ADVANTAGES

- » The HYDROVAR® concept allows optimum flexibility and ensures cost savings not only during operation but also in purchasing and commissioning
- » Easy operation and programming due to the improved menu navigation and the backlight display - even in difficult to access installations
- » Error Log with date and time stamp and included diagnostic menu to view temperature, current and quality of power supply, facilitates diagnostics and failure analysis
- » Easy to integrate into building management systems with MODBUS interface included as standard
- » Integrated functions to protect pump, motor and the overall system
- » Easy assembly of multi pump systems up to 8 pumps without any external control units or other superior control systems
- » Greater redundancy and additional application possibilities like zone regulation with 2 connected actual value sensors
- » Integrated dry-run protection to shut-off the system in case of pipe burst
- » Extended manual control mode with either external as well as internal set points of different speed levels



RETROFITTING

Old unregulated pump systems work inefficiently. Regardless of the demand the pumps are always running at full speed, wasting energy. As the HYDROVAR® fits to all standard asynchronous motors, nearly all existing systems can be upgraded. No hydraulic changes are usually necessary. Due to its simple installation and big energy savings, a payback time of less than one year can often be achieved.

- » Possible on all existing standard asynchronous motors, which are suitable for VSD operation
- » Automatic adjustment of the pump performance to varying demands
- » Constant system pressure in water supply and booster stations. Possibility of control along the system curve for circulation pumps for the HVAC market
- » No external panels, contactors and motor protection devices are required
- » All hydraulic control functions are included in the HYDROVAR®, therefore no additional external controllers are required
- » Optimised cooling of the HYDROVAR®; depending on the power and the speed of the pump, is guaranteed by the motor fan
- » Longer maintenance intervals because of less stress to the pump and the motor
- » The brilliant mounting method of the HYDROVAR® unit allows a very simple, fast and inexpensive retrofitting on existing pumps

Energy is the largest cost of running any pump, with the biggest potential savings. The HYDROVAR® works with your system to make it efficient. This intelligent variable speed drive controls the pump exactly according to the current requirements of the customers.

Compared to an unregulated system, the HYDROVAR® saves up to 70% of the energy consumption (as tested by TÜV Austria, vogw0312-PIR-ZR). The smooth regulation at optimal operation increases not only the efficiency but also the life of the system's components and reduces maintenance costs.

END SUCTION CENTRIFUGAL PUMPS



Open Impeller
Close Coupled Pump

CO Series

General purpose, open impeller pumps particularly suitable for industrial service with moderately aggressive liquids containing suspended solids.

APPLICATIONS

- » Metal washing and surface treatment
- » Produce washing in the packaging industry
- » Washing equipment for the food industry
- » Textile industry
- » Industrial washing machines
- » Commercial dishwashers

SPECIFICATIONS

- » Flows to 54 m³/hr
- » Heads to 24m
- » Power up to 3kW
- » Maximum liquid temperature: -10°C to +120°C
- » Maximum solid sizes: CO350 11mm, CO500 20mm
- » Maximum working pressure: 8 bar, PN8
- » IP55 TEFC class F motor as standard
- » Voltages
 - Single phase: 220 - 240V / 50Hz
 - Three phase: 380 - 415V / 50Hz

FEATURES

- » All pump parts in contact with fluid made of AISI 316L stainless steel
- » Threaded connections to pipe work, pump having an open impeller design for increased wear capabilities
- » Special seal options available
- » Also available as COF version; frame mount for 2 and 4 pole applications
- » Additional open impeller design pumps: see SHO series on page 39



PERFORMANCE CURVES AT 2850 RPM

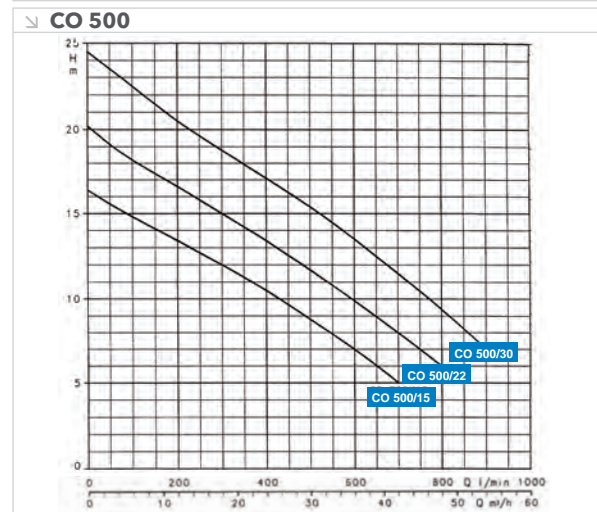
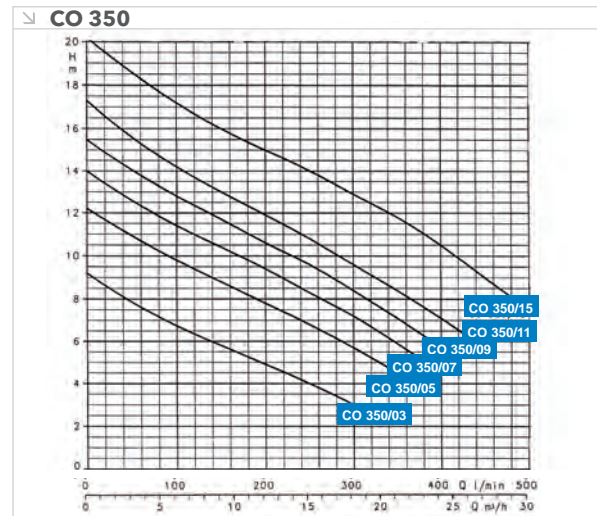

MATERIAL TABLE

COMPONENT	MATERIAL
Pump casing, mechanical seal housing and impeller	STAINLESS STEEL (AISI 316L - DIN 1.4404)
Shaft	STAINLESS STEEL (AISI 316L - DIN 1.4404)
Filler and discharge plugs	STAINLESS STEEL (AISI 316L - DIN 1.4404)
Mechanical Seal (standard)	CERAMIC/CARBON
Mechanical Seal (option)	SIL.CARB./TUNGS.CARB
Elastomers	FPM

END SUCTION CENTRIFUGAL PUMPS



Stainless Steel Close Coupled End Suction Pump

CEA Series

General purpose, single impeller (CEA) pumps suitable for domestic and industrial service.

APPLICATIONS

- » Transfer of water and clean moderately aggressive fluids
- » Water supply
- » Water circulation
- » Pressure boosting
- » Irrigation
- » Dairy services
- » Vat wash

SPECIFICATIONS

- » AS/NZS 4020 Compliant; Suitable for drinking water
- » Flows to 31m³/hr
- » Heads to 32m
- » Power up to 3kW
- » Maximum liquid temperature:
 - NBR +85°C
 - FPM +110°C
- » Maximum working pressure: 8 bar (PN8)
- » IP55 TEFC motor standard
- » Insulation Class: F
- » Voltages
 - Single phase: 220 - 240V / 50Hz
 - Three phase: 380 - 415V / 50Hz
- » Continuously rated

FEATURES

- » Back pull out design
- » Liquid-end in all stainless steel construction



MATERIAL TABLE

COMPONENT	MATERIAL
Pump body, flange, back plate, diffuser	STAINLESS STEEL (AISI 316- DIN 1.44404)
Impeller	STAINLESS STEEL (AISI 316- DIN 1.44404)
Shaft Extension	STAINLESS STEEL (AISI 316- DIN 1.44404)
Filling and drain plugs	STAINLESS STEEL (AISI 316- DIN 1.44404)
Mechanical seal	CARBON/CERAMIC
O-rings	FPM

OPTIONS

- » Also available with AISI 304 - DIN 1.4301 Stainless Steel wetted parts and NBR Elastomers

END SUCTION CENTRIFUGAL PUMPS

SINGLE IMPELLER VERSION - PERFORMANCE CURVES AT 2850 RPM

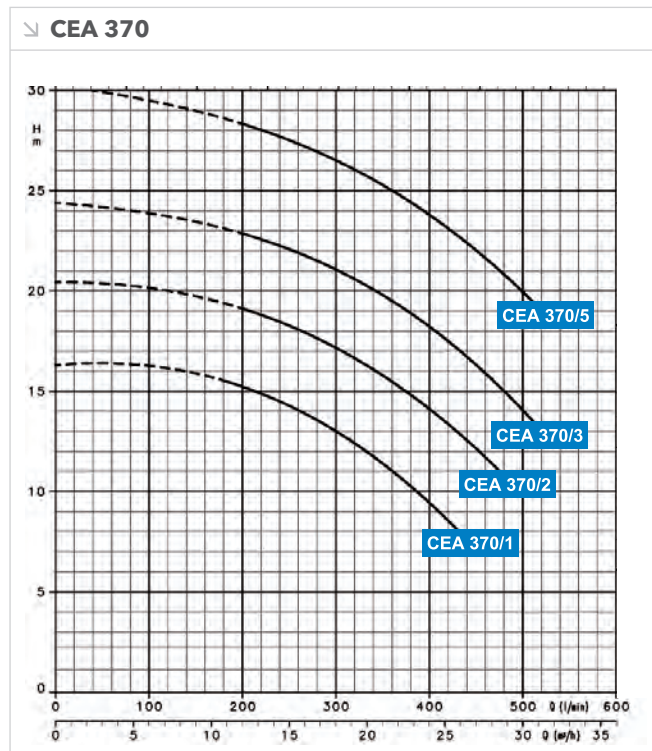
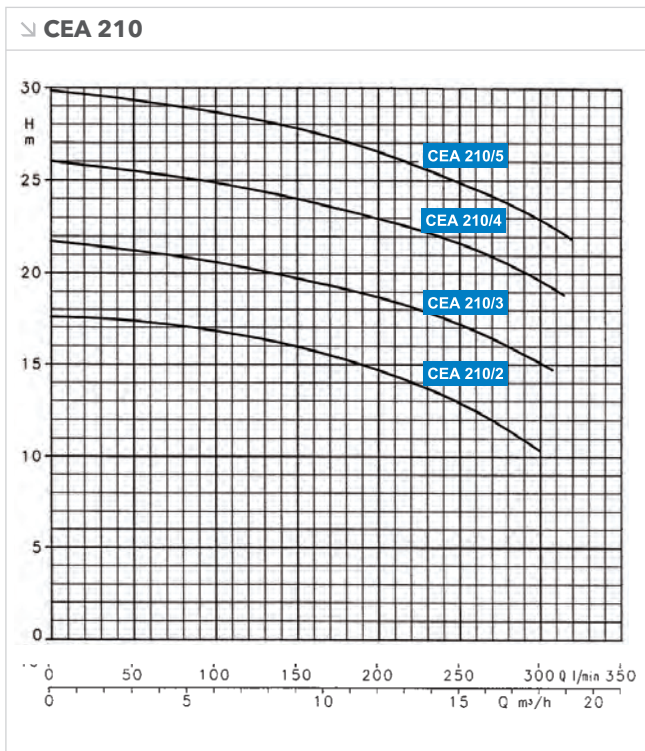
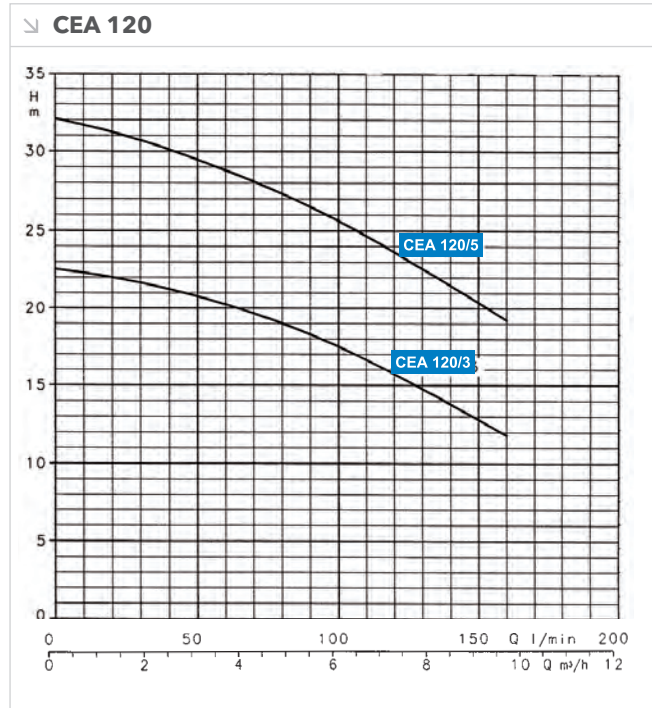
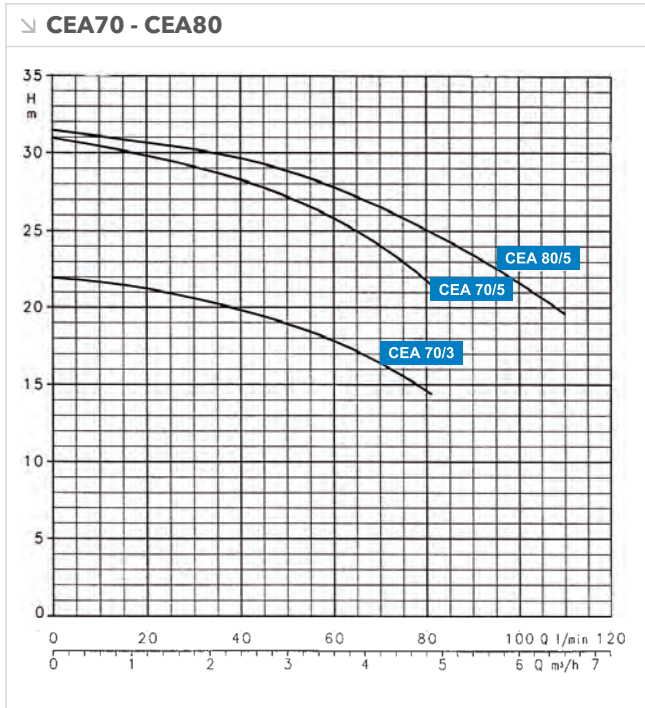

MOTOR POWER - SINGLE IMPELLER

Single Phase	CEAM 70/3	CEAM 70/5	CEAM 80/5	CEAM 120/3	CEAM 120/5	CEAM 210/2	CEAM 210/3	CEAM 210/4	CEAM 210/5	CEAM 370/1	CEAM 370/2	CEAM 370/3
kW	0.37	0.55	0.75	0.55	0.9	0.75	1.1	1.5	2.2	1.0	1.5	1.85

END SUCTION CENTRIFUGAL PUMPS

Stainless Steel Close Coupled Twin Impeller End Suction Pump

CA Series

General purpose, single impeller (CEA) pumps suitable for domestic and industrial service.

APPLICATIONS

- » Transfer of water and clean moderately aggressive fluids
- » Water supply
- » Water circulation
- » Pressure boosting
- » Irrigation
- » Dairy services
- » Vat wash

SPECIFICATIONS

- » AS/NZS 4020 Compliant; Suitable for drinking water
- » Flows to 12.5m³/hr
- » Heads to 62m
- » Power up to 3kW
- » Maximum liquid temperature:
 - Standard +85°C
 - Optional +110°C
- » Maximum working pressure: 8 bar (PN8)
- » IP55 TEFC motor standard
- » Insulation Class: F
- » Voltages
 - Single phase: 220 - 240V / 50Hz
 - Three phase: 380 - 415V / 50Hz
- » Continuously rated

FEATURES

- » Back pull out design
- » Liquid-end in all stainless steel construction



MATERIAL TABLE

COMPONENT	MATERIAL
Pump body, flange, back plate, diffuser	STAINLESS STEEL (AISI 316- DIN 1.44404)
Impeller	STAINLESS STEEL (AISI 316- DIN 1.44404)
Shaft Extension	STAINLESS STEEL (AISI 316- DIN 1.44404)
Filling and drain plugs	STAINLESS STEEL (AISI 316- DIN 1.44404)
Mechanical seal	CARBON/CERAMIC
O-rings	FPM

END SUCTION CENTRIFUGAL PUMPS

TWIN IMPELLER VERSION - PERFORMANCE CURVES AT 2850 RPM

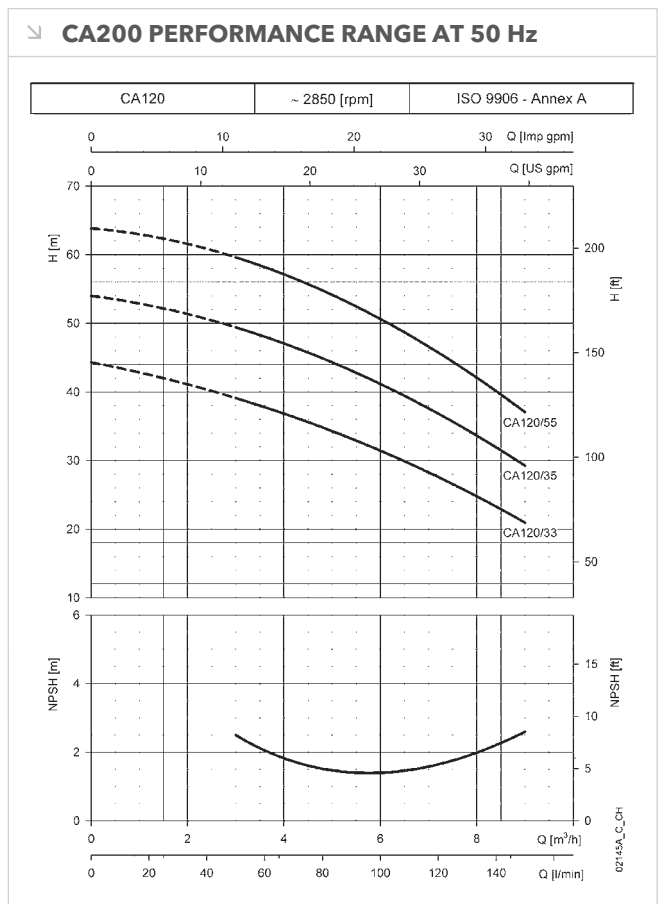
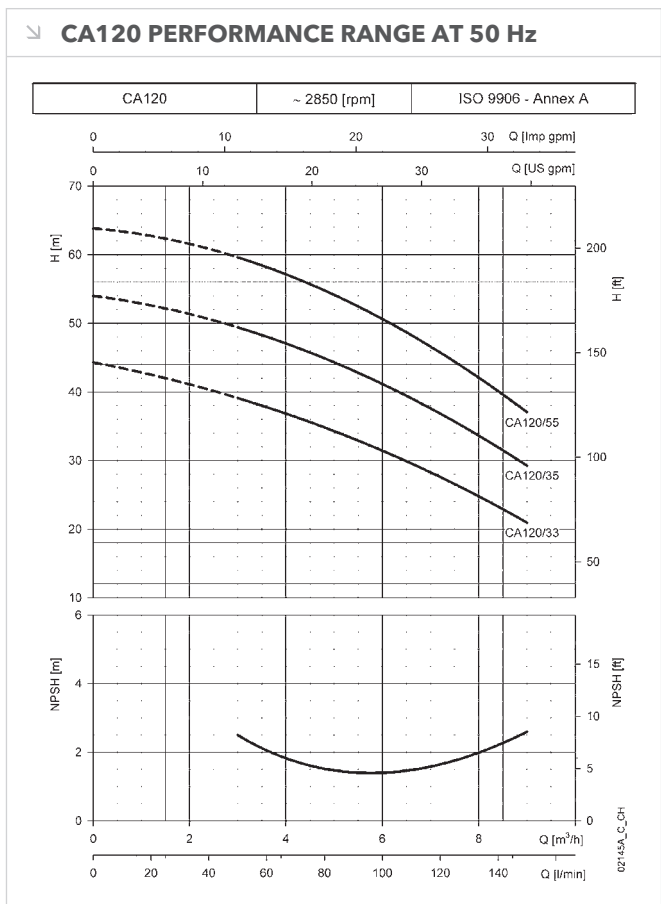
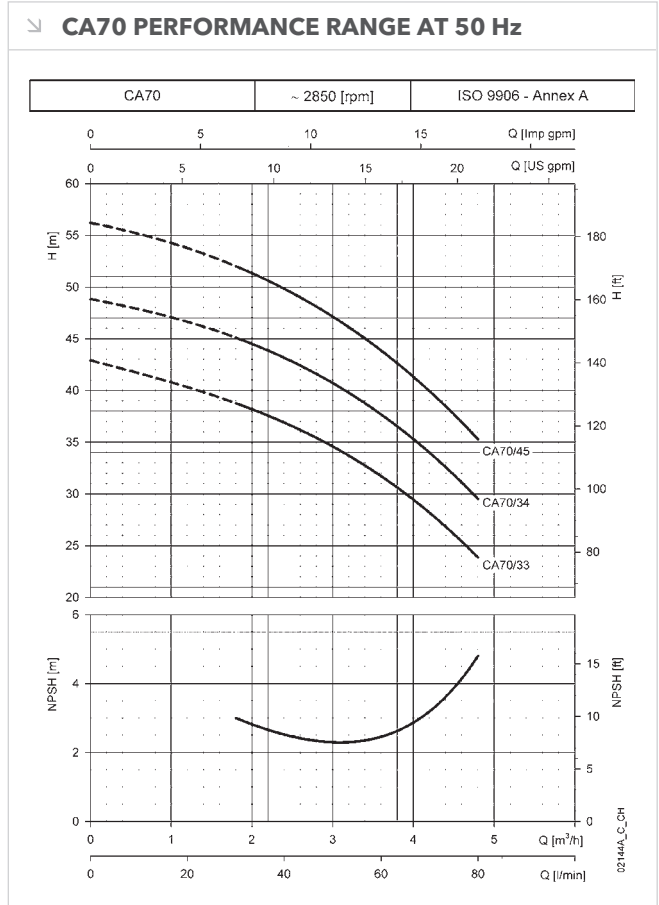
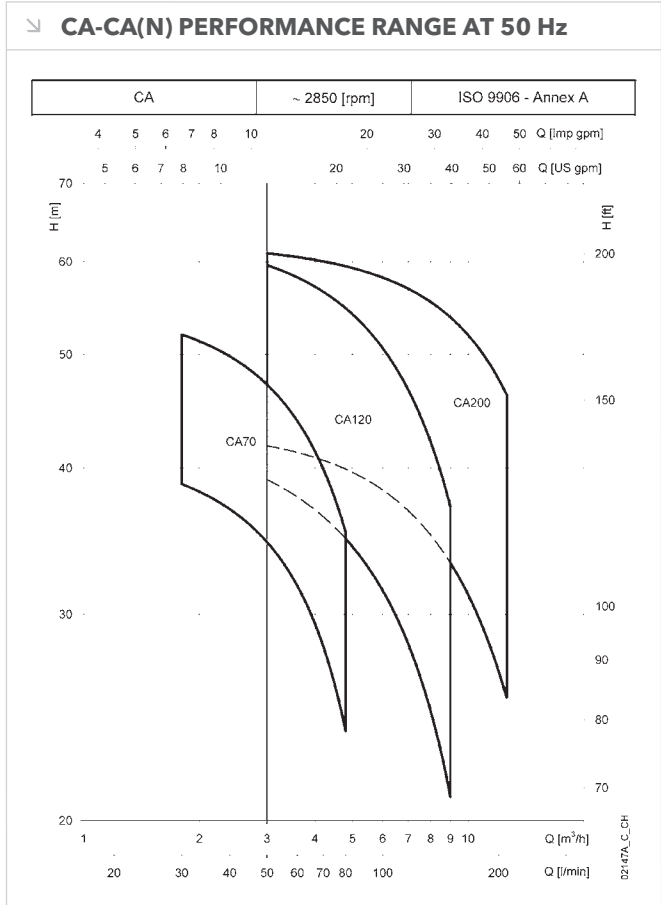

These performances are valid for liquids with density $\rho = 1.0 \text{ Kg/dm}^3$ and kinematic viscosity $\nu = 1 \text{ mm}^2/\text{sec}$.

END SUCTION CENTRIFUGAL PUMPS

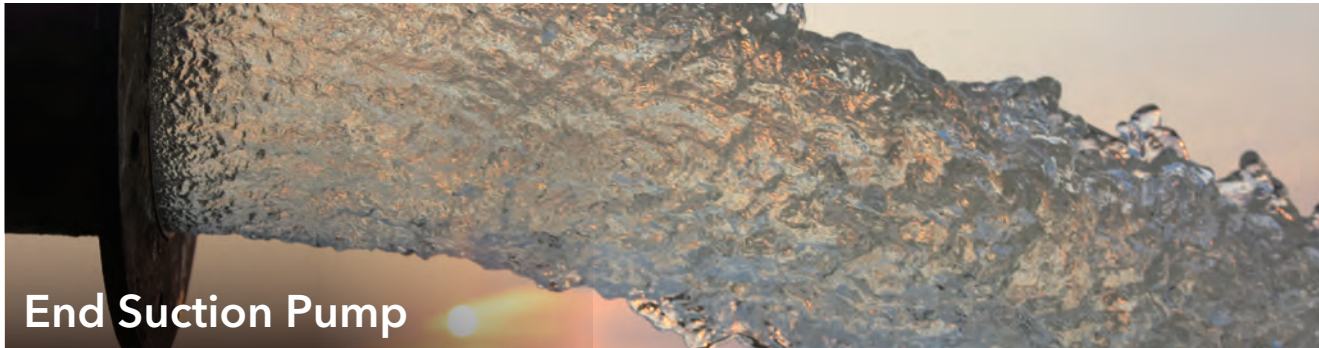

eNSC Series

Built with the highest level of flexibility and modularity, the new Lowara e-NSC series is ideal for transport and a vast array of industrial applications.

APPLICATIONS

- » Water transport
- » HVAC
- » District energy
- » Firefighting
- » Greenhouse heating/cooling
- » Desalination
- » Aquaculture
- » Power plant

SPECIFICATIONS

- » DN: 32-300
- » Flow: Up to 1800m³/hr
- » Head: Up to 160m
- » Power: From 0.25kW to 355kW
- » Pressure: PN16
- » Temperature: Up to 140°C

FEATURES

- » Liquid temperatures from -25°C to 140°C
- » Standard pressure of 16 bar over the entire range
- » Low NPSH for improved open-loop applications
- » Optimized space management with our compact configuration with motor (17% reduction)
- » Wide configuration options: compact, block and frame-mounted designs
- » Wide material options for casing and impeller, from bronze to super-duplex
- » Wide mechanical seal options: from single unbalanced seals to double cartridge configurations, with a variety of materials to accommodate all pumped fluids
- » Optional advanced bearing frame for heavier-duty applications



DESIGN CONFIGURATION

- » NSCE - Extended shaft
- » NSCS - Stub shaft
- » NSCF - Frame mounted
- » NSC - Bare Shaft
- » Local Australian Construction
- » Close Coupled & Long Coupled
- » MEPS Approved High Efficiency motors
- » Galvanized Baseplate

MATERIAL TABLE

COMPONENT	MATERIAL
Pump body	CAST IRON CLASS 25B
Impeller 32, 40, 50, 65-125	AISI 316 L
Impeller 65-80	CAST IRON CLASS 25B
Seal housing	CAST IRON CLASS 25B
Adaptor	ALUMINIUM OR CAST IRON
Mechanical seal	CERAMIC/CARBON/NITRILE
Wear ring	AISI 316 L
Fill/drain plug	NICKEL PLATED BRASS

END SUCTION CENTRIFUGAL PUMPS

PERFORMANCE CURVES AT 2900 RPM

HYDRAULIC PERFORMANCE RANGE AT 50 Hz, 2 POLES

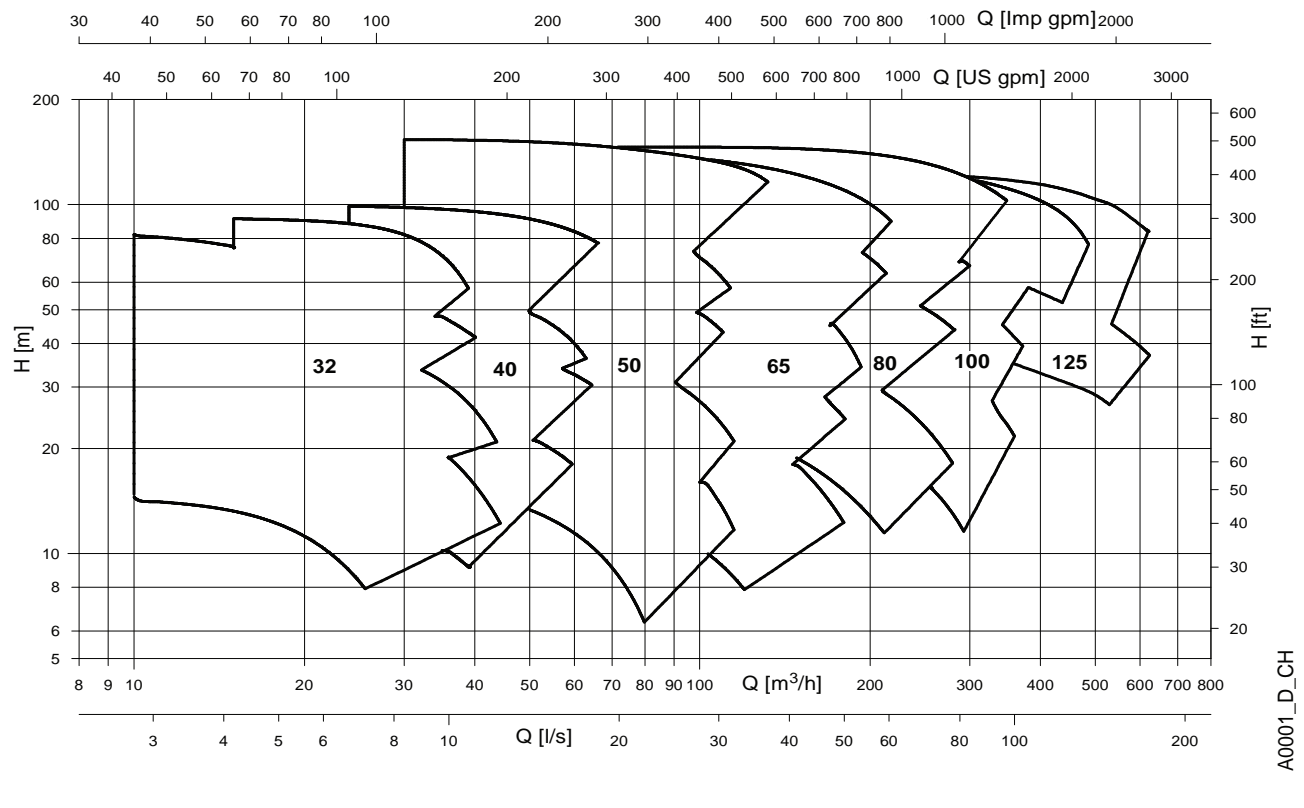

HYDRAULIC PERFORMANCE RANGE AT 50 Hz, 4 POLES

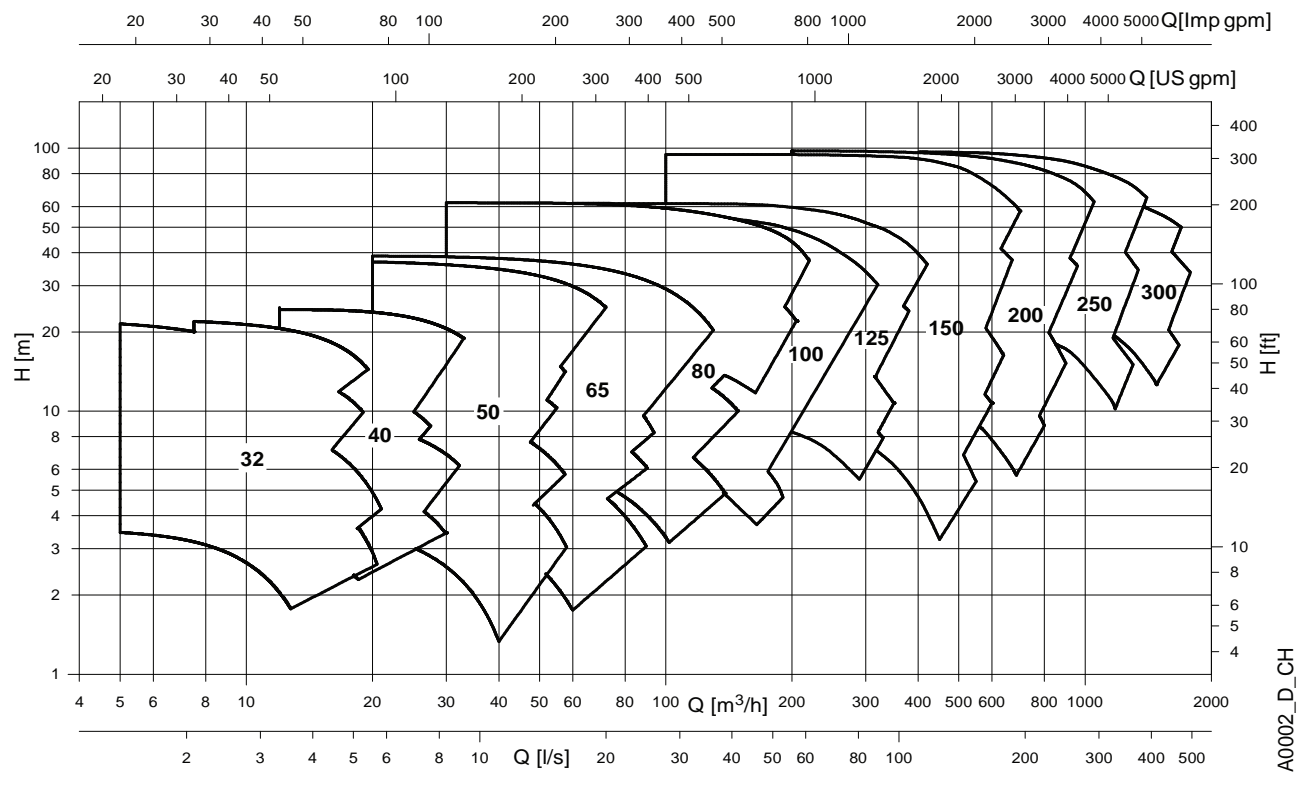

END SUCTION CENTRIFUGAL PUMPS



eSH Series

A pump designed to handle hot, cold and moderately aggressive fluids with high strength, efficiency and reliability through the extensive use of laser welding technology.

APPLICATIONS

- » Water supply and pressure boosting
- » Transfer of moderately aggressive fluids for industrial processes
- » Hot and cold water circulation for heating ventilation and airconditioning systems
- » Ideal for use with the HYDROVAR® pump mounted Variable Speed Drive: see page 31- 32

SPECIFICATIONS

- » Flows to 240 m³/hr
- » Heads to 110m
- » Liquid temperature limitations
Standard: -10°C to +120°C
- » Maximum operation pressure: 12 bar (PN12)
- » IP55 TEFC Class F motor as standard
- » Standard voltage 380-415V / 50Hz

FEATURES & OPTIONS

- » All pump parts in contact with fluid made of AISI 316L stainless steel
- » Closed impeller design in either AISI 316L laser welded or cast CF8M construction
- » Complies with EN 733, ex DIN 24255 and UNI-EN 1092-1
- » Back pull out design for ease of service

DESIGN CONFIGURATION OPTIONS

- » eSHE - Extended shaft
- » eSHS - Stub shaft (subject to availability)
- » eSHF - Frame mounted (subject to availability)
- » Elastomers in component and NBR in material

Standard Variant eSHS Stocked in Australia



MATERIAL TABLE

COMPONENT	MATERIAL
Pump body	AISI 316 L
Impeller	AISI 316 L
Seal housing	AISI 316 L
Wear rings	AISI 316 L
Adaptor	ALUMINIUM OR CAST IRON CLASS 25 B
Mechanical Seal	CERAMIC/CARBON/FPM
O-ring	FPM
Fill drain plugs	STAINLESS STEEL
Shaft	AISI 316

SHO Series

Open impeller version of the eSH pump to handle fluids with small suspended particles or solids. Impeller in cast CF8M stainless steel, capable of passing solids of 20mm to 40mm depending upon model.

- » Flows to 56m³/hr
- » Heads to 50m

DESIGN CONFIGURATION OPTIONS

- » SHOE - Extended motor shaft
- » SHOS - Stub shaft
- » SHOD - Double seal arrangement



END SUCTION CENTRIFUGAL PUMPS

PERFORMANCE CURVES FOR eSH SERIES

HYDRAULIC PERFORMANCE RANGE AT 50 Hz, 2 POLES

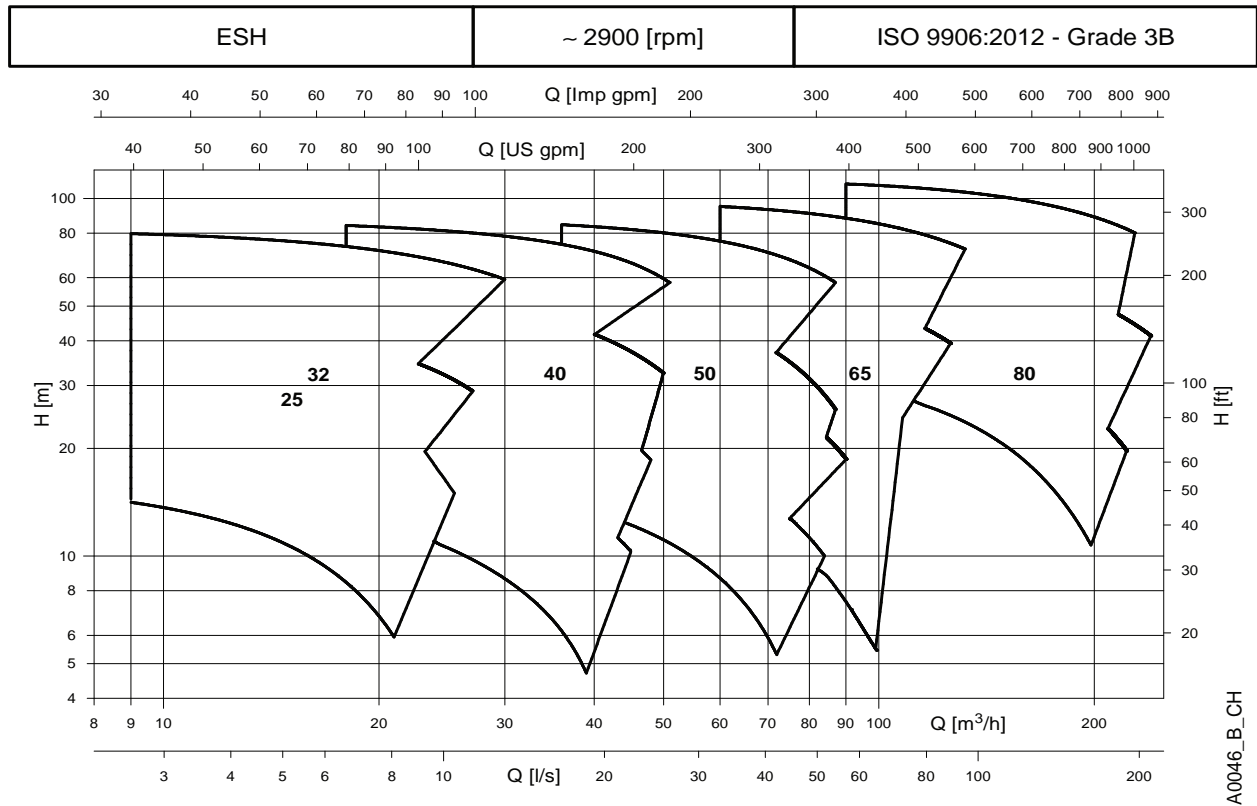

HYDRAULIC PERFORMANCE RANGE AT 50 Hz, 4 POLES

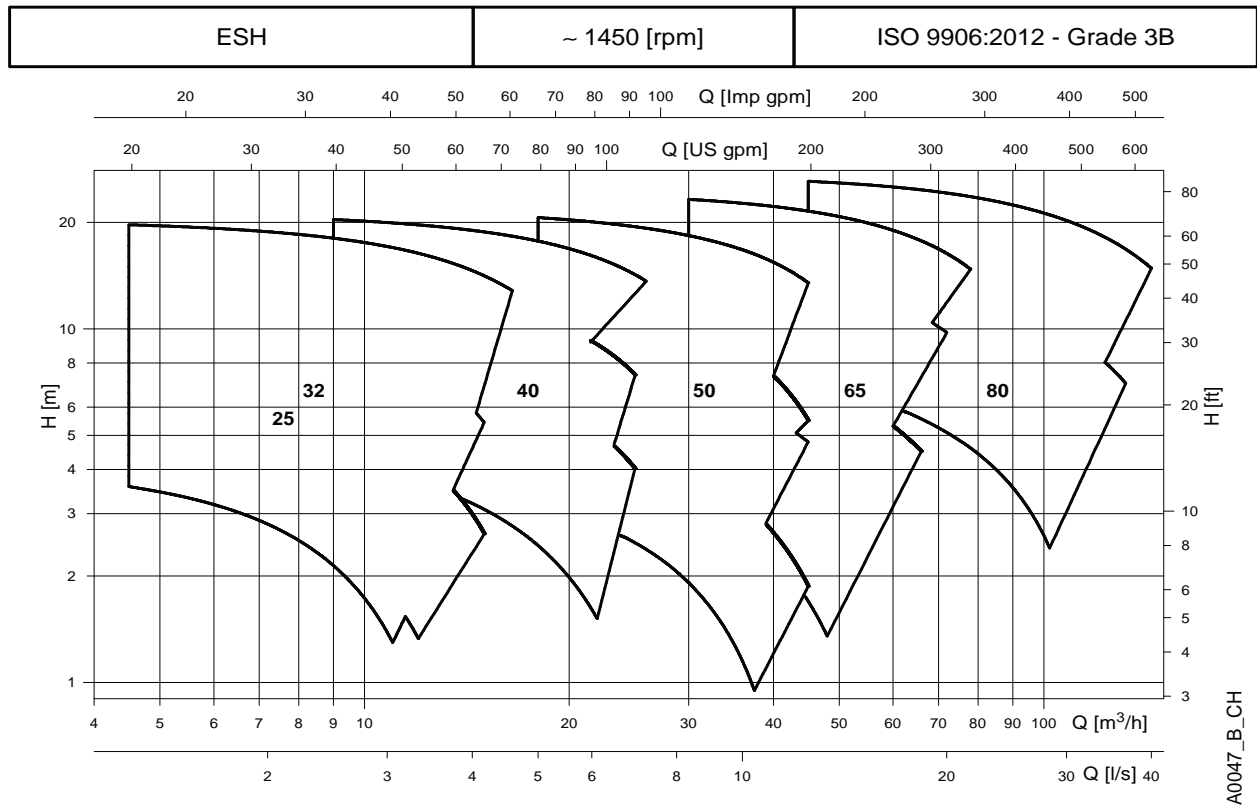

▾ SUBMERSIBLE PUMPS FOR DEWATERING & SEWAGE



Submersible Dewatering

DOC Series



Compact, versatile and light weight. Suitable for clean and domestic water applications.

▾ APPLICATIONS

- » Emptying of residential areas such as cellars and pits
- » Pumping domestic wastewater
- » Emptying water tanks and storage vessels

▾ SPECIFICATIONS

- » Flow up to 14 m³/hr
- » Heads up to 11m
- » Solid handling DOC3 - DOC7 to 10mm
DOC7VX to 20mm
- » Built in thermal overload protection
- » Manual and automatic start
- » Maximum pump down level 50mm
- » Maximum depth of submergence 5m
- » Cable length 5m, options to 10m
- » Maximum liquid temperature +40°C
- » DOC 7 has a capacity of up to 13.5 m³/hr and delivery head of up to 11m and is suitable for 10 mm solids in suspension
- » DOC 7VX has a capacity of up to 10.5 m³/hr and 7m maximum head delivery. It can pump liquid with solids in suspension having maximum dimensions of 20mm
- » Versions
 - Single phase 220 - 240V 50Hz 2 pole
 - Three phase 380 - 415V 50Hz 2 pole

▾ FEATURES

- » Built in capacitor
- » Built in thermal motor protection
- » Single phase versions can be equipped with pre-assembled float for automatic pump operation
- » New single phase DOC GW version with magnetic float switch (replaces GT version)
- » Three phase version available

PERFORMANCE CURVE AT 2850 RPM

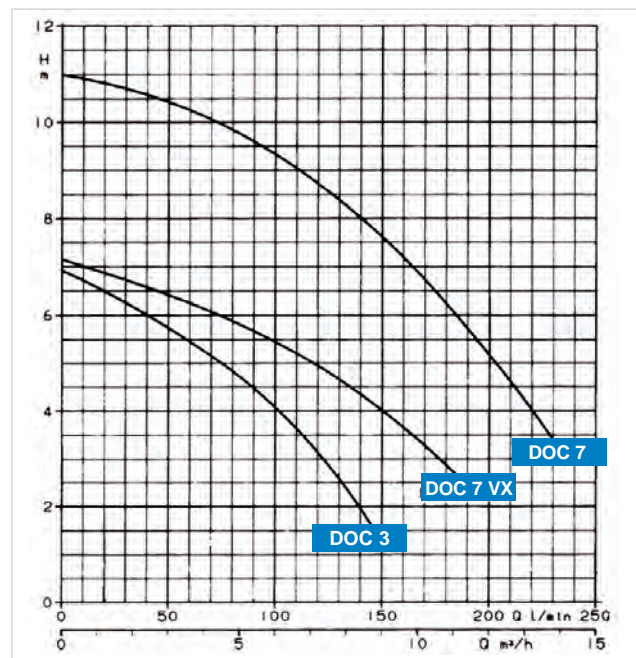

MATERIAL TABLE

COMPONENT	MATERIAL
Pump body and inlet grill	TECHNOPOLYMER
Handle and upper support	TECHNOPOLYMER
Impeller	TECHNOPOLYMER
Outer casing	STAINLESS STEEL (AISI 304)
Motor casing	STAINLESS STEEL (AISI 304)
Lower casing	STAINLESS STEEL (AISI 304)
Shaft extension	STAINLESS STEEL (AISI 304)
Screws and bolts	STAINLESS STEEL (AISI 304)
Elastomers	NITRILE RUBBER (NBR)

SUBMERSIBLE PUMPS FOR DEWATERING & SEWAGE



DIWA Series



For drainage of cellars, sumps, basements and tanks, dirty water transfer, garden irrigation, fountains and water features.

FEATURES

- » Flows to 25 m³/hr
- » Heads to 20m
- » Open impeller for solids to 8mm
- » Coated replaceable wear plate
- » Lowara double mechanical seal system
- » 4 models up to 1.5kW
- » Maximum submergence 7m
- » Manual and automatic models

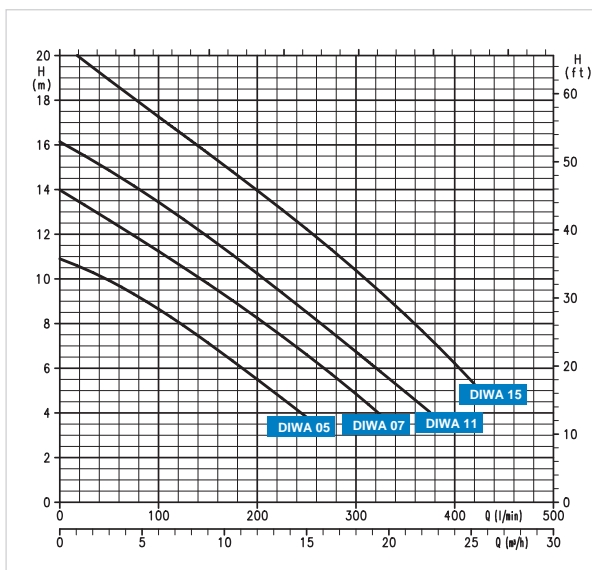

DN Series



Submersible pumps for dirty water. Made in cast iron and stainless steel, with mechanical seal and open impeller with abrasion-resistant rubber coating. Supplied with or without float switch.

APPLICATIONS

- » Emptying of drains, rain water tanks or domestic wastewater
- » Emptying of wells and tanks in industrial and ecological applications
- » Lawn and garden irrigation
- » Emptying of tanks or reservoirs
- » Emergency draining in flooded areas

SPECIFICATIONS

- » Flow up to 17 m³/hr
- » Heads up to 20m
- » Maximum depth of submergence 5m

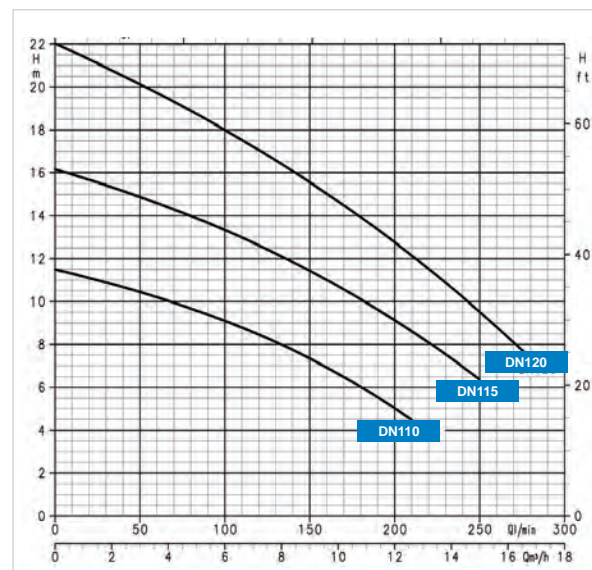

SUBMERSIBLE PUMPS FOR DEWATERING & SEWAGE



Submersible Wastewater

DOMO Series



For drainage of cellars, sumps, basements, tanks, dams and dirty water transfer.

- » Flows to 40 m³/hr
- » Heads to 14m
- » Twin channel and vortex impeller versions
- » Single phase versions up to 1.1kW
- » Three phase versions up to 1.1kW
- » Lowara DRIVELUB double seal system
- » Maximum solids handling
 - 35mm for DOMO 7 and DOMO 7VX
 - 50mm for DOMO 10-15-20
 - 50mm for DOMO 10-15-20VC
- » Maximum submergence: 5m
- » Manual and automatic models

APPLICATIONS

- » Emptying of septic tanks and residential sumps
- » Pumping of effluent (the VX version also pumps suspended solids)
- » Emptying of wells and tanks in industrial and ecological applications
- » Emptying of tanks and reservoirs
- » Emergency draining in flooded areas

SPECIFICATIONS & FEATURES

- » Pump body and motor casing: stainless steel
- » Shaft: stainless steel
- » Handle: nylon
- » DOMO 7 (VX) Impeller: reinforced nylon
- » DOMO 10-15-20 (VX) impeller: stainless steel
- » Upper lip seal: NBR

DOMO VX

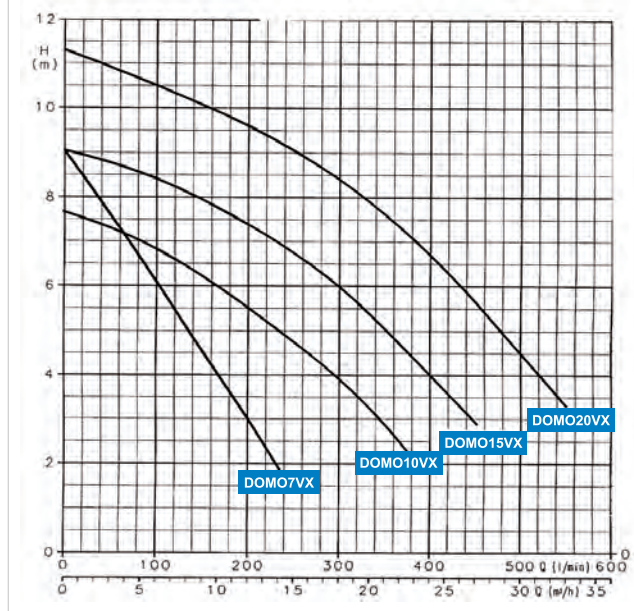

DOMO

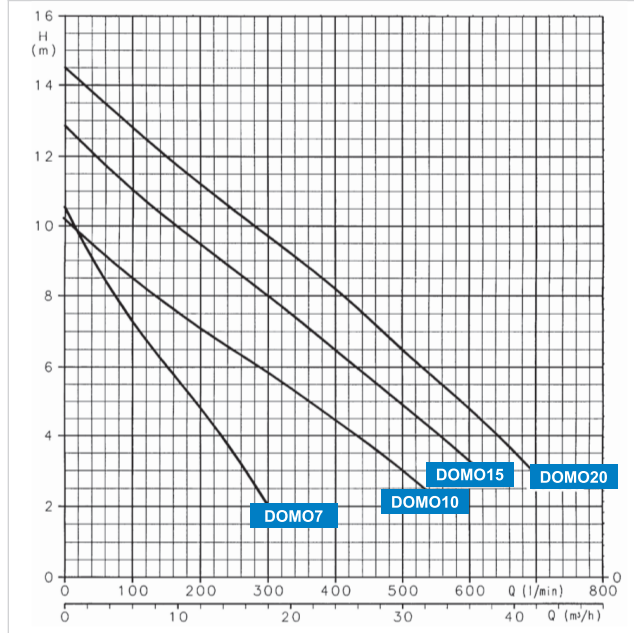

SUBMERSIBLE PUMPS FOR DEWATERING & SEWAGE



Grinder



DOMO GRI Series



The pump has been designed to deliver domestic sewage, waste water and fluids containing solids from residential to sewer mains. Features grinder system and efficient pump to make a reliable package.

APPLICATIONS

- » Residential and domestic sewage

SPECIFICATIONS

- » Flow up to 11.5m³/h
- » Head up to 28m
- » Maximum liquid temperature: 35°C when pump is fully submersed
- » Insulation Class F
- » Maximum immersion depth of 5m
- » Single phase versions 220-240V, 50Hz, 2 poles
- » Three phase versions 380-415V, 50Hz, 2 poles
- » SiC/SiC/NBR mechanical seal

FEATURES

- » Built in capacitor
- » Thermal overload protection
- » DRIVELUBE Seal System
- » New 1.5kW versions (single phase & three phase)
- » New 1.1kW High Flow version (single phase & three phase)

OPTIONS

- » Single phase with float for auto-operation
- » Lowering and connection systems to suit

DOMO GRI

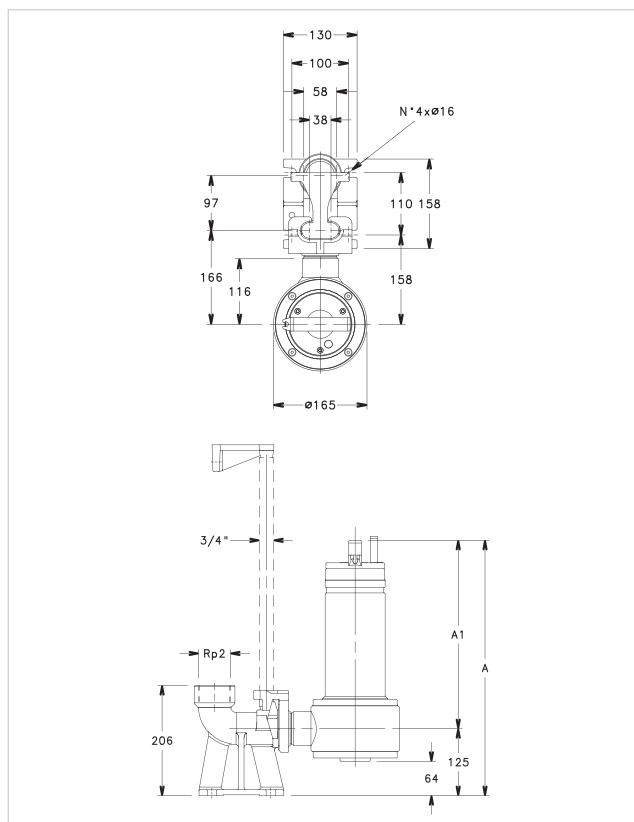
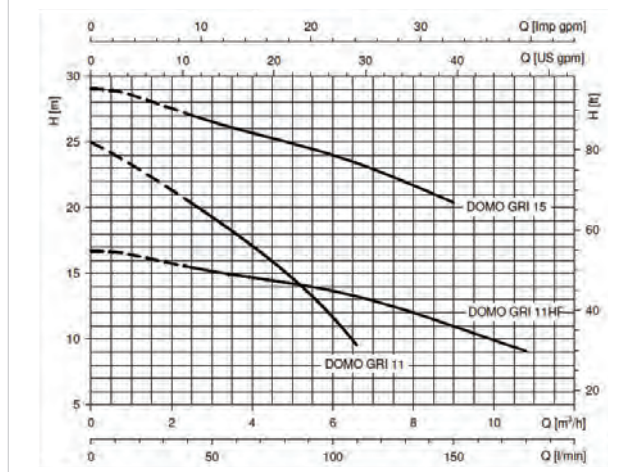

SUBMERSIBLE PUMPS FOR DEWATERING & SEWAGE



Large Submersible Wastewater

GL & DL Series



Submersible pumps designed for drainage of waste water from cesspools, collecting tanks, excavations, dams and dirty water transfer.

FEATURES

- » Flows to 42 m³/hr
- » Heads to 21m
- » Maximum submergence: 5m
- » Lifting devices available

GL-GLV SERIES WITH CAST IRON MOTOR

- » 304SS construction impellers in single-channel or vortex design
- » Mechanical seal protected by sand labyrinth
- » Single and three phase versions to 2.2kW
- » Maximum liquid temperatures
+30°C partially submerged / +50°C full submerged

DL-DLV SERIES WITH SOLIDS HANDLING CAPABILITIES & STAINLESS STEEL MOTOR

- » Single-channel or vortex impeller designs
- » Mechanical seal of SiC/SiC/NBR construction as standard
- » Single and Three phase versions to 1.5kW
- » Maximum liquid temperatures:
+25°C partially submerged / +50°C full submerged
- » Maximum solids handling:
 - 45mm: DL80, 90, 105
 - 50mm: DL109, 125, 160, DLV100, 115

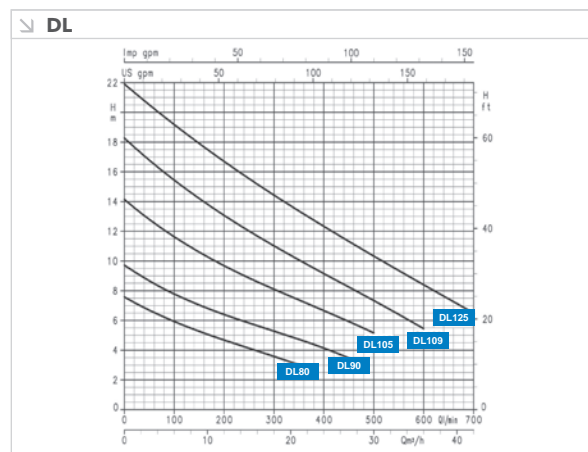
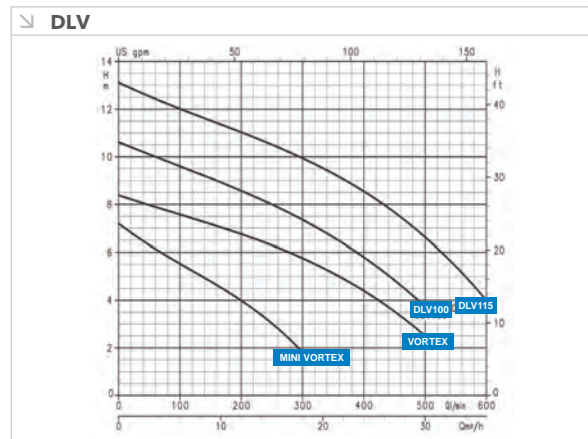
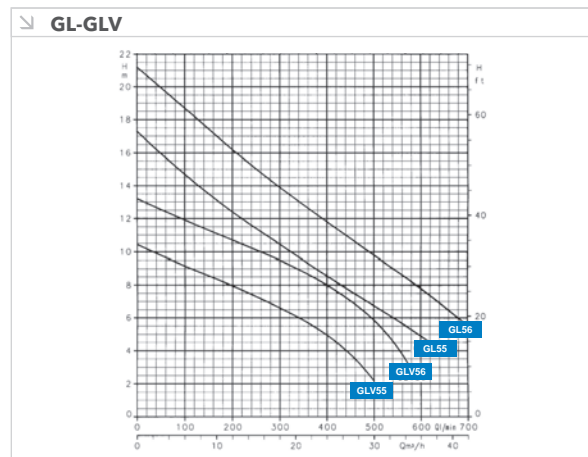

SUBMERSIBLE PUMPS FOR DEWATERING & SEWAGE



Multistage Centrifugal Submersible Pump

SCUBA Series

The SCUBA Series of pumps are specifically designed for clean water pumping with major components in 304SS. The liquid end and motor are combined in one package with the pump fluid providing the motor cooling. These pumps can be directly installed into tanks or wells to avoid suction problems and noise.

APPLICATIONS

- » Water supply from tank, 6" wells and basins
- » Rain water tank collection
- » Pressure boosting
- » Irrigation

SPECIFICATIONS & FEATURES

- » Flow up to 7.5 m³/hr
- » Heads to 80m
- » Maximum submergence: 20m
- » Single and three phase versions available
- » Single phase includes internal capacitor and thermal protection
- » Water temperature 0°C to +40°C
- » Suspended solids to 2.5mm
- » Single phase available in automatic or manual control

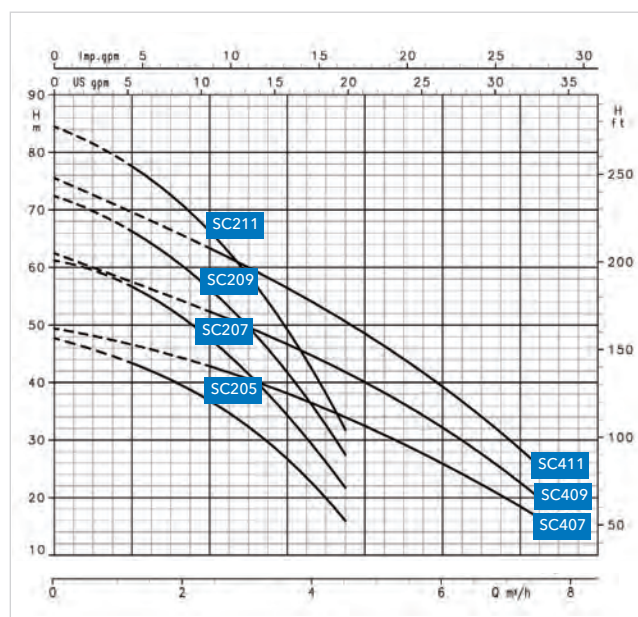

SUBMERSIBLE PUMPS FOR DEWATERING & SEWAGE



Lowara 1300 Series

With a variety of combinations of non-clog and vortex impellers to choose from, it's easy to find a pump for your needs. The impeller design gives you efficiency and solids handling capability. This helps to ensure smooth operation and delivers savings in terms of maintenance costs and energy consumption.

All pumps in the series feature a motor designed for reliable operation in submersible applications. The motors have F-class insulation or better, which allows for continuous running without overheating, ensuring optimal cooling and long lifetime.

Typically these pumps are installed in permanent installations. However, some models have the option of a free-standing installation so that the pump can be easily moved from one site to another.



APPLICATIONS

- » Domestic sewage pumping stations
- » Wastewater pumping stations
- » Retention basins
- » Storm water pumping stations
- » Drainage water
- » Domestic sewage pumping stations
- » Ground water

FEATURES

- » **Robust**
All components are made from robust materials for easy maintenance and long life
- » **Powerful**
Motor is specifically designed for reliable operation in submersible applications. It can run continuously without overheating – a true workhorse
- » **Durable**
Heavy-duty bearings with long life provide peace of mind
- » **Environmentally friendly**
Cooling system is designed to use the surrounding media to cool the pump; no use of environmentally hazardous fluids such as oils
- » **Safe and straightforward**
Cable entry prevents both cable strain and leakage
- » **Smooth**
The double mechanical seal provides extra reliability and protects against leakage
- » **Flexible**
Non-clog and vortex impellers are available

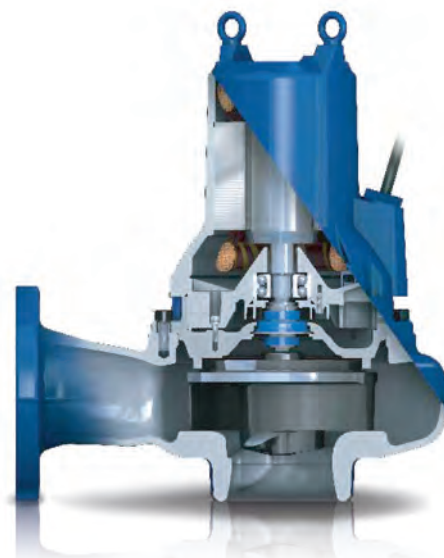

SUBMERSIBLE PUMPS FOR DEWATERING & SEWAGE

Installation Methods and Accessory Kits

The Lowara 1300 series is designed to fit your needs. You start with a bare pump and order the right kit depending on your desired installation method.

WET-WELL KIT

The pump is installed with twin guide bars on a discharge connection.

KIT CONTENTS

- » Discharge connection
- » Anchor bolts
- » Guide claw with bolts
- » Upper guide bar bracket with bolts

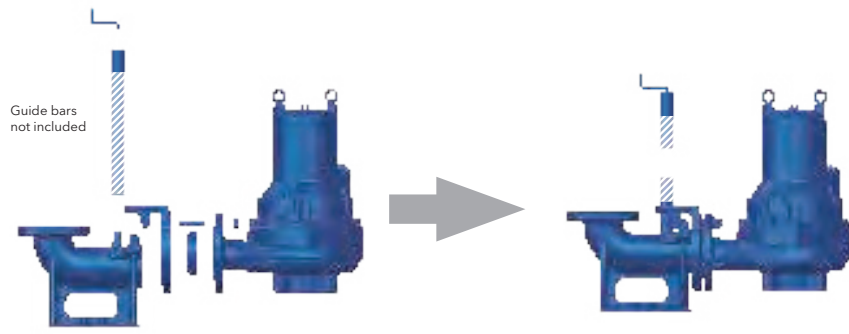

REPLACEMENT KIT

Simple kit to replace an old pump or upgrade to a larger model

KIT CONTENTS

- » Guide claw with bolts

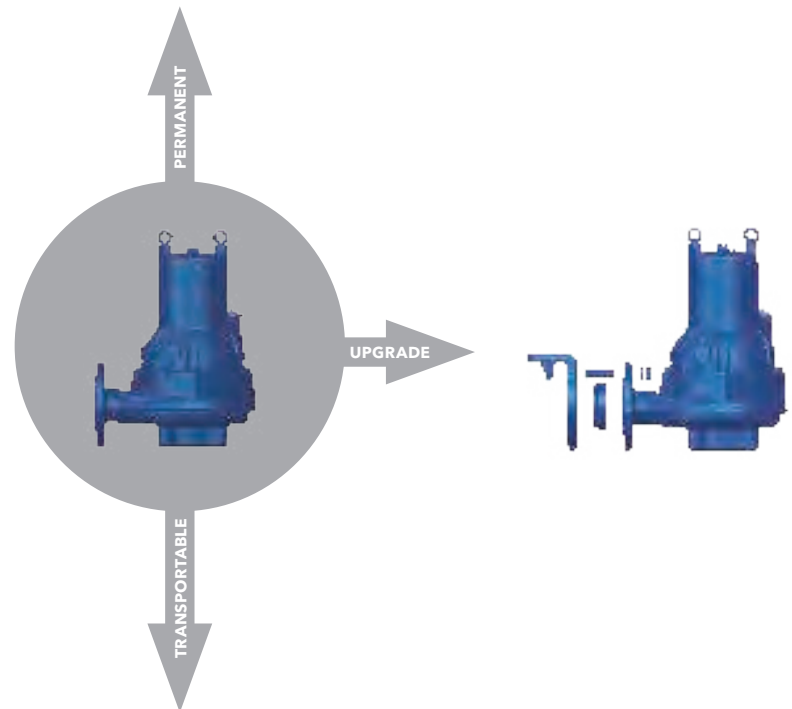

FREE-STANDING KIT

Ideal for portability

KIT CONTENTS

- » Hose connection with bolts
- » Stand with bolts



Goolds Water Technology Pumps

The following are selected pump models from our wide range of Goolds Water Technology offering, which includes a variety of robust cast construction pumps suitable for diverse applications.

Comprehensive catalogues are available for each individual series.

GIS-GISO Series: Horizontal Centrifugal ISO Pumps

- » Delivery: Max 900 m³/hr
- » Fluid temperature: -15°C to +120°C
- » Working pressure: Max 16 bar
- » Complies with International standard ISO 2858

APPLICATIONS

- » Water supply
- » Heating and airconditioning system
- » Fire protection
- » Spray irrigation and transfer
- » Boiler water supply
- » Industrial transportation
- » Vehicle washing





Heavy duty ISO2858, End Suction Pump Design
Table E Flange standard for Irrigation Market for easy retrofit.
Proven reliability in Australia's harshest conditions over the last 20 Years.
Widely supported by over 75 Xylem service personnel, across fifteen service locations nationwide, as well as throughout our national distribution network.



**BUILT
STOCKED
TESTED &
SUPPORTED IN
AUSTRALIA**

GOULDS WATER TECHNOLOGY PUMPS

GISO End Suction Centrifugal Pump - 50Hz Performance Range

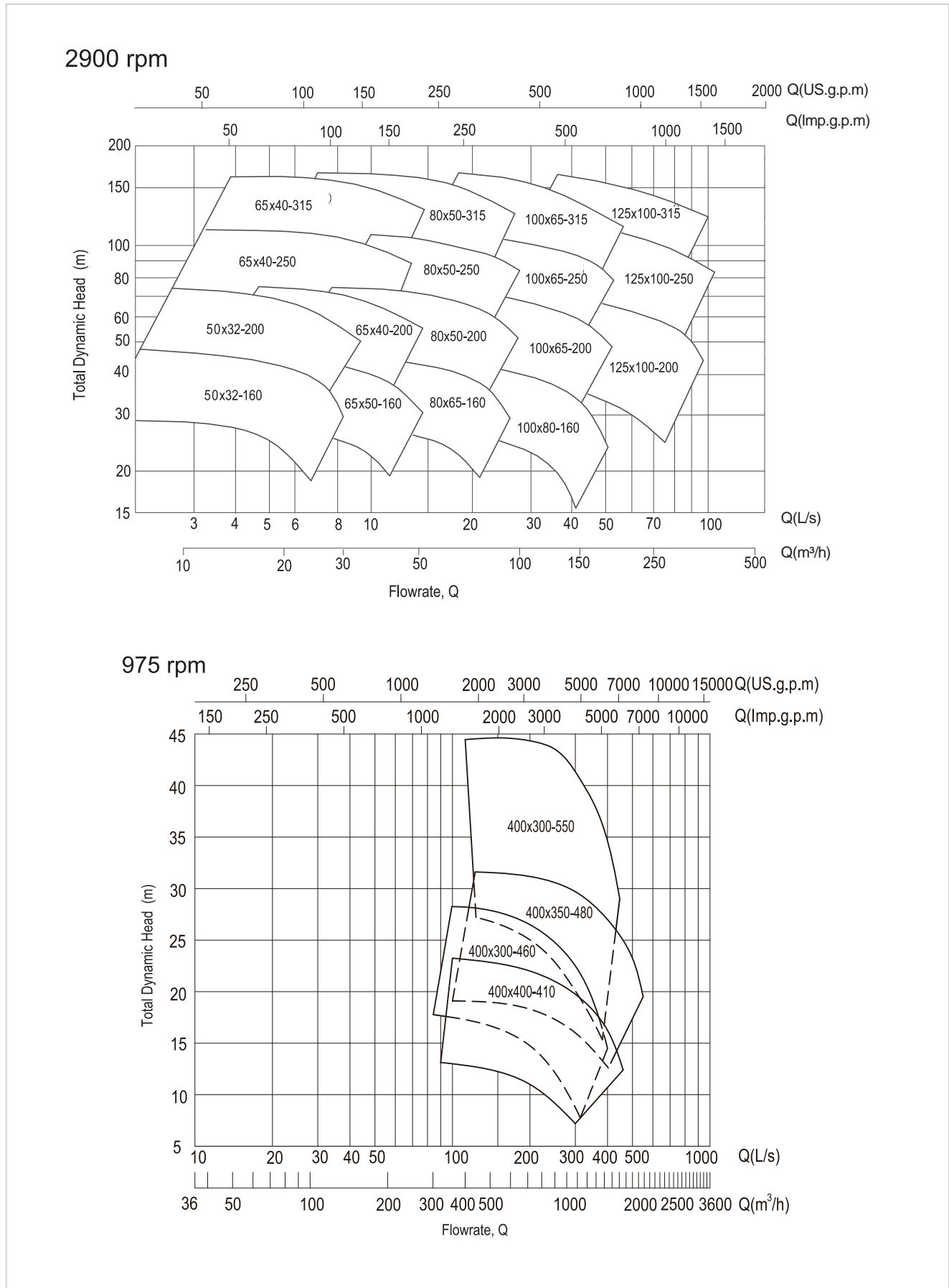

GOULDS WATER TECHNOLOGY PUMPS



Multipurpose Lineshaft and Submersible Turbines

Lineshaft & Submersible Turbines

With over 150 years of water pumping solutions, Goulds lineshaft and submersible turbines offer tremendous flexibility in turbine design options to suit any application. The range of locally assembled turbines is limited to select 7" models through to 11" models as standard, with features such as 316SS impellers for the majority of models, 630SS shaft, vesconite suction & discharge bearings and cast iron bowls with glass lined internal waterways.

APPLICATIONS

- » Irrigation
- » Municipal water supply
- » Pressure booster systems
- » Dewatering
- » Fire fighting
- » Mine dewatering

FEATURES

- » **Discharge Adaptor/Pipe**
Adaptor sized for optimum water velocities, BSP connection as standard (not shown). Discharge pipe supplied by others
- » **Check Valve**
Built in as standard, close grained, Class 30 C.I. designed for minimum losses and long life. Please add additional check valve in the line at least every 60 metres
- » **Check Valve Plunger**
With positive sealing, construction in stainless steel for corrosion resistance
- » **Intermediate Bowl**
Sand cast Class 30 cast iron with internal glass lined or epoxy coated waterways on 7" and larger bowls for maximum efficiency and abrasion resistance
- » **Intermediate Bowl Bearings**
Fluted rubber bearings as standard, with premium vesconite available as an alternative (bronze bearings are standard for submersible models)
- » **Taper Lock Collets**
Accurately machined to ensure positive locking of impeller to pump shaft
- » **Impellers**
Designed for maximum efficiency with wide range hydraulic coverage. Precision balanced for smooth operation; 316SS impeller material as standard for select models up to 14"
- » **Bowl Fasteners**
High quality stainless steel
- » **Motor/Suction Adaptor**
Ductile iron provides increased strength and positive motor alignment, contoured for smooth flow and minimum suction losses. Open area permits easy access to pump/motor coupling
- » **Suction Bearing**
Long bearing ensures positive shaft alignment and stabilization for extended life
- » **Suction Screen/Inlet**
Protected by oversized stainless steel strainer to prevent entrance of damaging solids
- » **Pump/Motor Coupling**
Large stainless steel coupling accurately machined for perfect alignment, balance and power transmission
- » **Cable Guard**
Robust mechanical protection for motor lead, stainless steel for corrosion resistance
- » **Pump Shaft**
100,000 PSI high tensile stainless steel provides strength and excellent corrosion resistance, ground and polished for smooth bearing surface
- » **Uphrust Collar**
Designed with extra safety margin to absorb momentary upthrust on startup



GOULDS WATER TECHNOLOGY PUMPS

PERFORMANCE CURVES FOR SUBMERSIBLE TURBINE PUMPS

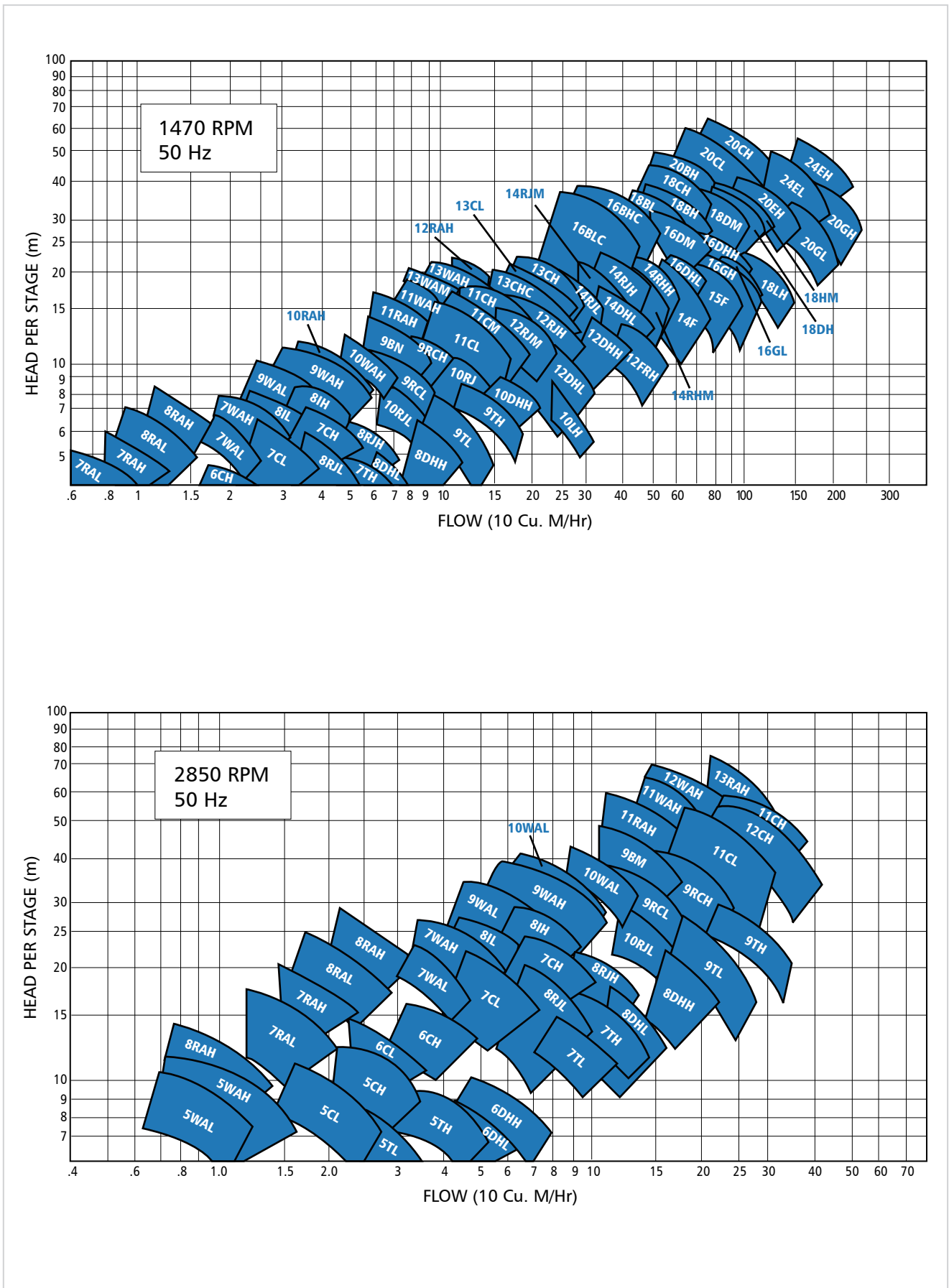

LOWARA VOGEL SERIES PUMPS



e-MP Series: Cast Construction Multistage Pumps

APPLICATIONS

- » Water supply
- » Heating and airconditioning
- » Fire protection
- » Spray and irrigation
- » Boiler water supply
- » Industrial fluid
- » Transportation
- » Vehicle washing equipment

SPECIFICATIONS

- » Delivery: up to 850 m³/h
- » Head: up to 950 m
- » Power supply: three-phase 50 and 60 Hz
- » Power: from 2,2 kW up to 1.250 kW
- » Maximum operating pressure: 100 bar
- » Temperature of pumped liquid: from -25°C to +140°C (optional to +180°C)

DESIGN VERSIONS

- TYPE e-MPD:**
Double Bearing Horizontal Mount - Higher possible inlet pressure, optional drive on suction side
- TYPE e-MPA:**
End Suction Horizontal Mount - Highest suction capability (the lowest NPSH) thanks to ideal axial inlet flow, reduced wear due to fewer parts, small horizontal footprint
- TYPE e-MPR:**
Radial Suction Horizontal Mount - Higher suction nozzle flexibility, reduced wear due to fewer parts, small horizontal footprint
- TYPE e-MPV:**
Vertical Mount - Smallest footprint, 4 positions by nozzle (90°, 180°, 270°, 360°)

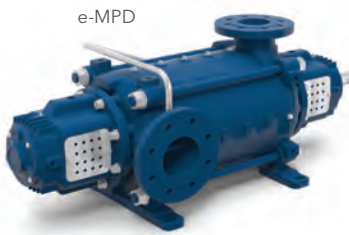

e-MPD



e-MPR



e-MPA

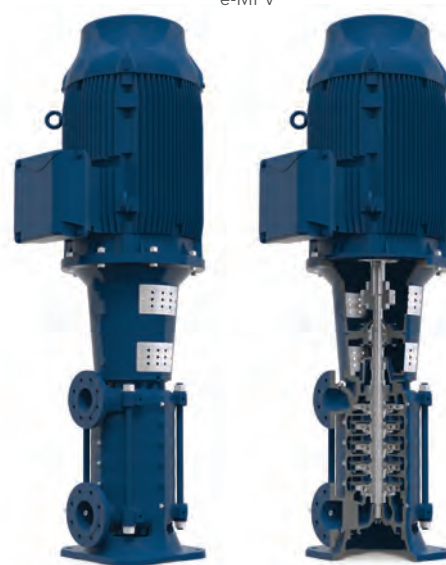

e-MPV

GHV BOOSTER SETS



Vertical Multistage Booster Sets

GHV / SV Series

Lowara GHV series booster sets are designed to transfer and increase the pressure of water in the following applications:

- » Hospitals
- » Schools
- » Public buildings
- » Industries
- » Hotels
- » Condominiums
- » Sports facilities
- » Mains water systems

GHV series booster sets are pumping stations assembled with two, three or four vertical multistage pumps from the e-SV series. The pumps are connected to one another by suction and delivery pipes, fixed onto a single base, and then connected to the manifolds by means of stop valves and check valves. An electric protection and control panel is installed using a bracket on the base of the set.



GHV / SV Series Hydraulic - 50Hz Performance Range

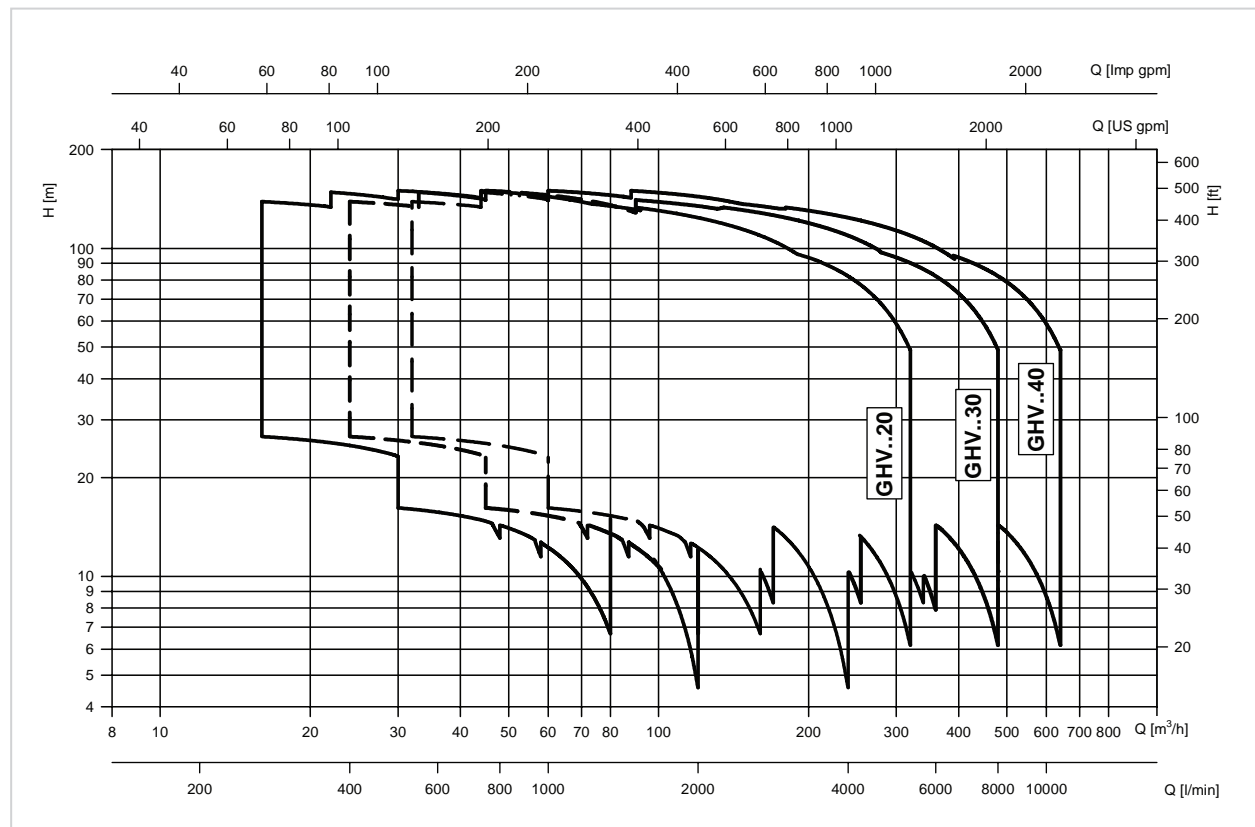

GHV BOOSTER SETS



GHV / SV Series

RANGE

The range of GHV series variable-speed booster sets includes models with two, three or four electric duty pumps to adapt to the specific needs of each application.

GHV20 SETS:

Variable speed sets equipped with HYDROVAR® Variable Speed Drive and two multistage vertical pumps with up to 22kW power

Head up to 160m
Flow rate up to 320 m³/h

GHV30 SETS:

Variable speed sets equipped with HYDROVAR® Variable Speed Drive and three multistage vertical pumps with up to 22kW power.

Head up to 160m
Flow rate up to 480 m³/h

GHV40 SETS:

Variable speed sets equipped with HYDROVAR® Variable Speed Drive and four multistage vertical pumps with up to 22kW power.

Head up to 160m
Flow rate up to 640 m³/h

**BUILT
STOCKED
TESTED &
SUPPORTED IN
AUSTRALIA**

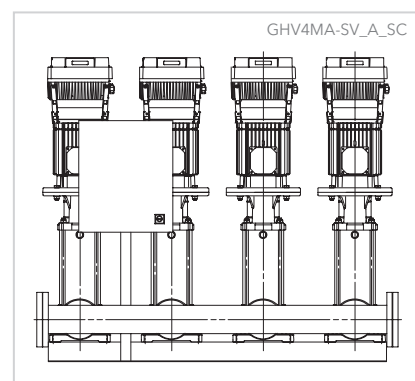
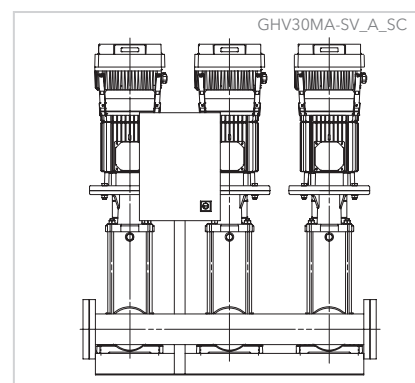
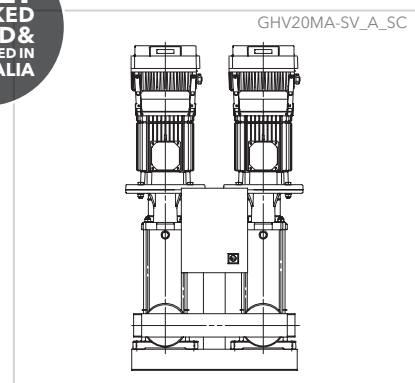

▶ PRESSURE TANKS



Pressure Wave

- » Single diaphragm design
- » NSF Standard 61, CE/PED, WRAS, ACS, ISO:9001, Gost approved
- » Patented stainless steel water connection
- » Virgin polypropylene liner
- » Two part polyurethane, epoxy primed paint finish
- » Leak free, o-ring sealed air valve cap
- » Comprehensive testing
- » No maintenance



C2 Lite

- » Patented CAD-2 diaphragm technology
- » Unique 3 piece construction
- » Reinforced plastic connection
- » Durable continuous strand fibreglass sealed with epoxy resin
- » Rugged copolymer polypropylene base
- » Quality brass air stem with o-ring seal
- » No sweat design
- » Comprehensive testing
- » No maintenance



Challenger Tank

- » Patented CAD-2 diaphragm technology
- » CE/PED, WRAS, ACS, ISO-9001, Gost, Evrazes approved
- » Stainless steel water connection
- » Condensation reducing design
- » Two part polyurethane, epoxy primed paint finish
- » Leak free air valve cap sealed with closed cell foam
- » Comprehensive testing
- » No maintenance



PUMP FUNDAMENTALS

System Curves

For a specific impeller diameter and speed, a centrifugal pump has a fixed and predictable performance curve.

The point where a pump will operate on its curve is dependent upon the characteristics of the system it is operating in. This is commonly called the System Head Curve. The head in a typical system is made up of three components:

1. Static head
2. Pressure head
3. All losses i.e. friction

This is represented in graphic form and since friction losses vary as the square of the flow rate, the system curve is parabolic in shape. By plotting the system head curve and the pump curve together, it can be determined:

1. Where the pump will operate on its curve
2. What changes will occur if the system curve or the pump performance curve changes

A centrifugal pump will always operate at the intersection of the system curve and the pump curve. This represents the head required to make liquid flow through the system piping, valves etc.

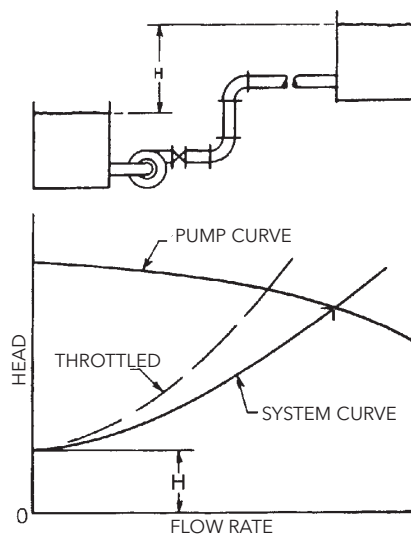

The diagram above represents a pump system. The parabolic shape of the system curve is determined by the friction losses through the pipework including all bends and valves. The suction and discharge tanks are on different levels resulting in a positive static head 'H'. The static head does not affect the shape of the system curve or its 'steepness', but it does dictate the head of the system curve at zero flow rate.

The operating point is at the intersection of the system curve and the pump curve. The flow rate can be reduced by closing, or 'throttling', the discharge valve. Throttling increases system friction losses and changes the system curve and the operating point of the pump.

Net Positive Suction Head (NPSH)

Simply stated, NPSH is an analysis of the energy conditions on the suction side of the pump to determine if the liquid will vapourise at the lowest pressure point of the pump.

The pressure that a liquid exerts on its surroundings is dependent on its temperature. This pressure is called its vapour pressure. It is a unique characteristic of every fluid and it increases with temperature. When the vapour pressure of a fluid equals the pressure of its surroundings, the fluid begins to vapourise, or boil.

If we wish to pump a fluid effectively we must keep it in liquid form. NPSH is simply a measure of the amount of suction head present to prevent this vapourisation at the lowest pressure point in the pump.

NPSH required is a function of the pump design and varies with speed and capacity.

NPSH available is a function of the system the pump is operating in. It is the excess pressure of the liquid, in metres absolute, over its vapour pressure as it arrives at the pump suction.

NPSH available must always be greater than

NPSH required at the maximum required flow rate.

The diagrams below show typical suction systems with NPSH available formulas applicable to each. It is important to correct for the specific gravity of the liquid and to convert all terms to units of metres absolute when using the formulas.

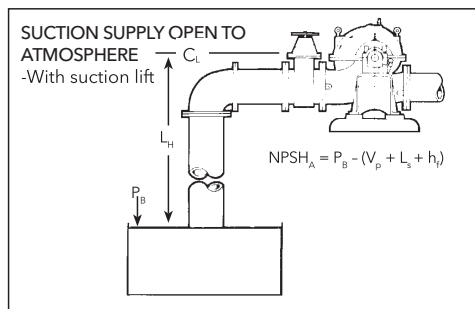
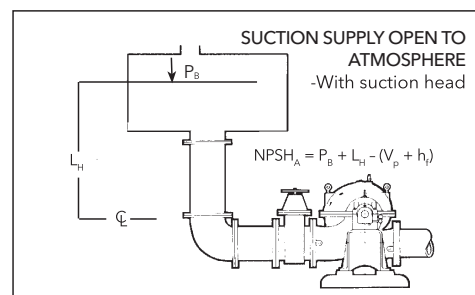

- PB = Barometric pressure, in metres absolute
- VP = Vapour pressure of the liquid at maximum pumping temperature in metres absolute
- LS = Maximum suction lift in metres
- LH = Maximum suction head in metres
- hf = Friction loss in the suction pipe at required capacity in metres

APPENDIX

PUMP FUNDAMENTALS

Friction Loss for PVC Pipe (m/100 metres of pipe)																
Flow Rate			25mm		32mm		40mm		50mm		80mm		100mm		150mm	
lps	lpm	m ³ /hr	PN 9	PN 12	PN 9	PN 12	PN 9	PN 12	PN 9	PN 12	PN 9	PN 12	PN 9	PN 12	PN 9	PN 12
0.2	12	0.72	0.43	0.49	0.14	0.16	0.08	0.42								
0.5	30	1.80	2.15	2.40	0.70	0.80	0.37	0.97	0.13	0.14						
0.8	48	2.88	4.91	5.50	1.61	1.82	0.84	1.43	0.29	0.33						
1.0	60	3.60	7.29	8.16	2.38	2.70	1.24	3.30	0.42	0.48	0.07	0.08				
1.6	96	5.76	16.85	18.87	5.49	6.23	2.86	4.90	0.97	1.11	0.15	0.18				
2.0	120	7.20			8.17	9.27	4.25	10.12	1.42	1.65	0.23	0.26	0.07	0.05		
3.0	180	10.8					8.77	16.98	2.97	3.40	0.46	0.53	0.14	0.08		
4.0	240	14.4							4.98	5.68	0.77	0.89	0.23	0.16		
5.0	300	18.0							7.43	8.49	1.15	1.32	0.34	0.26		
6.0	360	21.6									1.60	1.83	0.48	0.39	0.09	0.11
7.0	420	25.2									2.11	2.42	0.63	0.55	0.12	0.14
8.0	480	28.8									2.68	3.07	0.80	0.72	0.16	0.18
9.0	540	32.4									3.31	3.80	0.98	0.91	0.19	0.22
10.0	600	36.0									4.00	4.59	1.19	1.13	0.23	0.27
15.0	900	54.0											2.47	1.36	0.48	0.55
20.0	1200	72.0													0.81	0.93

Friction Loss for Poly Pipe (m/100 metres of pipe)																		
Flow Rate			25mm O.D.		32mm O.D.		40mm O.D.		50mm O.D.		63mm O.D.		75mm O.D.		90mm O.D.		110mm O.D.	
lps	lpm	m ³ /hr	PN 6.3	PN 12.5	PN 6.3	PN 12.5	PN 6.3	PN 12.5	PN 6.3	PN 12.5	PN 6.3	PN 12.5	PN 6.3	PN 12.5	PN 6.3	PN 12.5	PN 6.3	PN 12.5
0.2	12	0.72	2.12	2.97	0.56	0.90	0.02	0.32										
0.5	30	1.80	10.53	14.83	2.78	4.45	0.86	1.58	0.27	0.55								
0.8	48	2.88	24.24	34.17	6.37	10.20	1.97	3.62	0.61	1.25								
1.0	60	3.60			9.46	15.17	2.92	5.38	0.91	1.85	0.33	0.61	0.14	0.26				
1.6	96	5.76			21.88		6.73	12.41	2.08	4.25	0.75	1.13	0.33	0.49				
2.0	120	7.20					10.02	18.50	3.10	6.33	1.11	2.07	0.48	0.89	0.20	0.37		
3.0	180	10.8							6.39	13.07	2.29	4.27	0.99	1.83	0.42	0.76	0.16	0.29
4.0	240	14.4							10.70		3.82	7.15	1.65	3.05	0.69	1.27	0.27	0.49
5.0	300	18.0									5.70		2.46	4.55	1.03	1.89	0.40	0.72
6.0	360	21.6									7.92		3.42	6.32	1.43	2.63	0.55	1.00
7.0	420	25.2											4.51		1.88	3.46	0.72	1.32
9.0	540	32.4											7.09		2.96	5.45	1.14	2.07
10.0	600	36.0													3.58	6.59	1.37	2.50
15.0	900	54.0															2.85	5.20
20.0	1200	72.0															4.80	

Friction Loss for Poly Pipe - 20mm to 63mm (m/100 metres of pipe)																														
Flow in		Medium Density Polythene Pipe																												
lps	gals/hr	Rural Class B Pipe					PE80/PN8						PE80/PN10						PE80/PN12.5						PE80/PN16					
		3/4"	1"	1 1/4"	1 1/2"	2"	20	25	32	40	50	63	20	25	32	40	50	63	20	25	32	40	50	63	20	25	32	40	50	63
10	132	2.7	0.7	0.2	0.1	-	3.9	1.1	0.3	0.1	-	-	4.5	1.4	0.4	0.1	-	-	5.3	1.8	0.5	0.2	0.1	-	6.8	2.2	0.7	0.2	0.1	-
20	264	9.8	2.4	0.8	0.3	0.1	14.2	4.0	1.2	0.4	0.1	-	16.4	5.1	1.5	0.5	0.2	0.1	19.0	6.4	1.8	0.6	0.2	0.1	24.4	8.0	2.4	0.8	0.3	0.1
30	396	20.8	5.1	1.7	0.7	0.2		8.5	2.6	0.9	0.3	0.1		10.7	3.2	1.0	0.4	0.1		13.6	3.8	1.3	0.4	0.1		17.0	5.2	1.7	0.6	0.2
40	528		8.7	2.9	1.2	0.3			4.5	1.5	0.5	0.2			5.4	1.7	0.6	0.2			6.5	2.2	0.8	0.2			8.8	2.9	1.1	0.3
50	660		13.2	4.5	1.8	0.5			6.8	2.3	0.8	0.3			8.1	2.6	0.9	0.3			9.8	3.4	1.1	0.4			13.3	4.4	1.5	0.5
60	792		18.5	6.2	2.6	0.6			9.5	3.2	1.1	0.4			11.4	3.7	1.3	0.4			13.7	4.8	1.6	0.5			18.0	6.2	2.0	0.7
80	1056		30.1	10.6	4.4	1.1				5.5	1.8	0.6			6.3	2.3	0.7				8.1	2.7	0.9				10.5	3.5	1.2	
100	1320			16.1	6.6	1.6				8.3	2.7	0.9			9.5	3.4	1.1				12.2	4.1	1.3				15.9	5.3	1.7	
120	1584				9.3	2.3				3.8	1.3				4.8	1.5					5.8	1.9						7.4	2.4	
140	1848				12.3	3.0				5.1	1.7				6.4	2.0					7.7	2.5						9.8	3.2	
160	2112					3.9				6.5	2.2				8.1	2.6					9.8	3.2						12.6	4.2	
180	2376					4.8					2.7					3.3						3.9								5.2
200	2639					5.9					3.3					4.0						4.8								6.3
220	2904					7.0					3.9					4.7						5.7								7.5
240	3168					8.2					4.6					5.6						6.7								8.8
250	3300					8.9					5.0					6.0						7.2								9.5

Xylem |'zīləm|

- 1) The tissue in plants that brings water upward from the roots;
- 2) a leading global water technology company.

We're a global team unified in a common purpose: creating advanced technology solutions to the world's water challenges. Developing new technologies that will improve the way water is used, conserved, and re-used in the future is central to our work. Our products and services move, treat, analyze, monitor and return water to the environment, in public utility, industrial, residential and commercial building services settings. Xylem also provides a leading portfolio of smart metering, network technologies and advanced analytics solutions for water, electric and gas utilities. In more than 150 countries, we have strong, long-standing relationships with customers who know us for our powerful combination of leading product brands and applications expertise with a strong focus on developing comprehensive, sustainable solutions.

For more information on how Xylem can help you, go to www.xylem.com/au

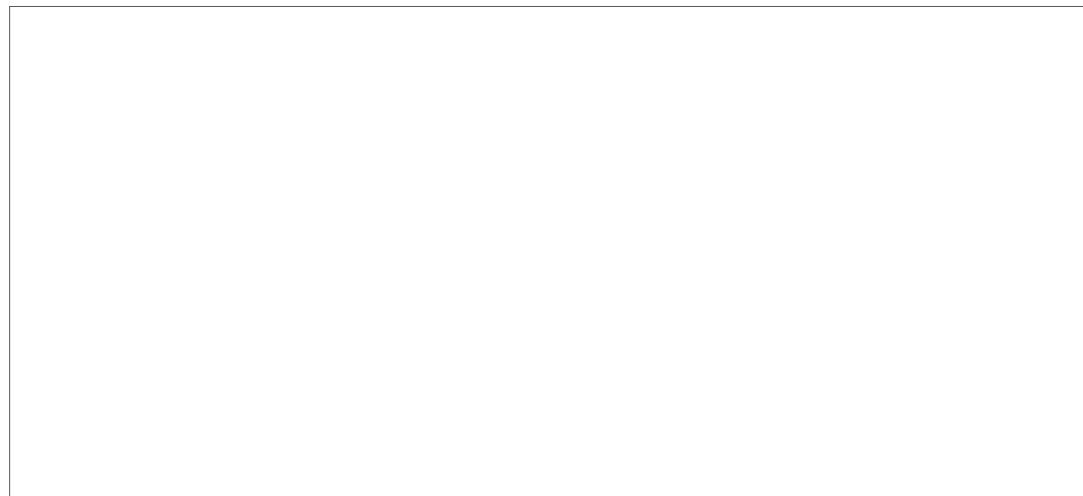

Xylem Water Solutions Australia Limited
Unit 2, 2 Capicure Drive
Eastern Creek, NSW 2766
Australia
Tel: 13 19 14

www.xylem.com/au

Lowara, Bell & Gossett and AC Fire Pump are trademarks of Xylem Inc.
Goulds is a registered trademark of Goulds Pumps, Inc. and is used under license.